

**THE**  
**epsilon**  
**BOOK**

A globe with a purple and blue color scheme, overlaid with white puzzle pieces. The puzzle pieces are arranged in a way that suggests a global network or interconnectedness. The globe is positioned behind the word "epsilon" in the title.

Dimitris Kolovos, Louis Rose, Antonio García-Domínguez, Richard Paige

Last update: July 29, 2018.

# Contents

<b>Contents</b>	<b>3</b>
<b>List of Figures</b>	<b>10</b>
<b>List of Tables</b>	<b>12</b>
<b>1 Introduction</b>	<b>15</b>
1.1 What is Epsilon?	15
1.2 How To Read This Book	16
1.3 Questions and Feedback	16
1.4 Additional Resources	16
1.4.1 Epsilon Website	16
1.4.2 EpsilonLabs	17
1.4.3 Twitter	17
<b>2 The Epsilon Model Connectivity Layer (EMC)</b>	<b>19</b>
2.1 The IModel interface	19
2.2 Loading and Persistence	19
2.3 Type-related Services	21
2.4 Ownership	21
2.5 Creation, Deletion and Modifications	21
2.6 The IModelTransactionSupport interface	22
2.7 The ModelRepository class	22
2.8 The ModelGroup class	22
2.9 Assumptions about the underlying modelling technologies	23
<b>3 The Epsilon Object Language (EOL)</b>	<b>25</b>
3.1 Module Organization	25
3.2 User-Defined Operations	27

3.2.1	Annotations	28
3.2.2	Pre/post conditions in user-defined operations	29
3.2.3	Operation Result Caching	30
3.3	Types	31
3.3.1	Primitive Types	34
3.3.2	Collections and Maps	37
3.3.3	Native Types	43
3.3.4	Model Element Types	44
3.4	Expressions	45
3.4.1	Literal Values	45
3.4.2	Feature Navigation	46
3.4.3	Arithmetical and Comparison Operators	47
3.4.4	Logical Operators	48
3.4.5	Enumerations	49
3.5	Statements	49
3.5.1	Variable Declaration Statement	49
3.5.2	Assignment Statement	50
3.5.3	Special Assignment Statement	51
3.5.4	If Statement	53
3.5.5	Switch Statement	53
3.5.6	While Statement	53
3.5.7	For Statement	54
3.5.8	Break, BreakAll and Continue Statements	55
3.5.9	Throw Statement	55
3.5.10	Transaction Statement	56
3.6	Extended Properties	57
3.7	Context-Independent User Input	58
3.8	Task-Specific Languages	60
<b>4</b>	<b>The Epsilon Validation Language (EVL)</b>	<b>63</b>
4.1	Motivation	63
4.1.1	Limited user feedback	64
4.1.2	No support for warnings/critiques	64
4.1.3	No support for dependent constraints	64
4.1.4	Limited flexibility in context definition	65
4.1.5	No support for repairing inconsistencies	66

4.1.6	No support for inter-model constraints . . . . .	66
4.2	Abstract Syntax . . . . .	67
4.3	Concrete Syntax . . . . .	69
4.4	Execution Semantics . . . . .	70
4.4.1	Capturing Dependencies Between Invariants . . . . .	71
4.5	Intra-Model Consistency Checking Example . . . . .	71
4.5.1	Scenario: The Singleton Pattern . . . . .	72
4.5.2	Using OCL to Express the Invariants . . . . .	72
4.5.3	Using EVL to Express the Invariants . . . . .	74
4.6	Inter-Model Consistency Checking Example . . . . .	77
4.7	Summary . . . . .	82
<b>5</b>	<b>The Epsilon Transformation Language (ETL)</b>	<b>83</b>
5.1	Style . . . . .	83
5.2	Source and Target Models . . . . .	84
5.3	Abstract Syntax . . . . .	84
5.4	Concrete Syntax . . . . .	84
5.5	Execution Semantics . . . . .	86
5.5.1	Rule and Block Overriding . . . . .	86
5.5.2	Rule Execution Scheduling . . . . .	87
5.5.3	Source Elements Resolution . . . . .	87
5.5.4	Overriding the semantics of the EOL SpecialAssignmentOperator . . . . .	89
5.6	Interactive Transformations . . . . .	90
5.7	Summary . . . . .	91
<b>6</b>	<b>The Epsilon Wizard Language (EWL)</b>	<b>93</b>
6.1	Motivation . . . . .	94
6.1.1	Automating the Construction and Refactoring Process . . . . .	94
6.2	Update Transformations in the Small . . . . .	95
6.2.1	Structure of Wizards . . . . .	95
6.2.2	Capabilities of Wizards . . . . .	96
6.3	Abstract Syntax . . . . .	97
6.4	Concrete Syntax . . . . .	98
6.5	Execution Semantics . . . . .	98
6.6	Examples . . . . .	98
6.7	Summary . . . . .	104

<b>7</b>	<b>The Epsilon Generation Language (EGL)</b>	<b>105</b>
7.1	Abstract Syntax . . . . .	105
7.2	Concrete Syntax . . . . .	106
7.2.1	Comments and Markers . . . . .	107
7.2.2	User-Defined Operations . . . . .	107
7.3	The OutputBuffer . . . . .	108
7.4	Co-ordination . . . . .	110
7.4.1	The Template type . . . . .	111
7.4.2	The TemplateFactory object . . . . .	113
7.4.3	An Example of Co-ordination with EGL . . . . .	114
7.4.4	Customising the Co-ordination Engine . . . . .	114
7.4.5	Summary . . . . .	117
7.5	Merge Engine . . . . .	117
7.6	Formatters . . . . .	118
7.6.1	Using a Formatter . . . . .	119
7.6.2	Implementing a Custom Formatter . . . . .	120
7.7	Traceability . . . . .	121
<b>8</b>	<b>The Epsilon Comparison Language (ECL)</b>	<b>123</b>
8.1	Abstract Syntax . . . . .	123
8.2	Concrete Syntax . . . . .	124
8.3	Execution Semantics . . . . .	126
8.3.1	Rule and Block Overriding . . . . .	126
8.3.2	Comparison Outcome . . . . .	126
8.3.3	Rule Execution Scheduling . . . . .	126
8.3.4	The <i>matches()</i> built-in operation . . . . .	127
8.3.5	Cyclic invocation of <i>matches()</i> . . . . .	128
8.4	Fuzzy and Dictionary-based String Matching . . . . .	129
8.5	Interactive Matching . . . . .	130
8.6	Exploiting the Comparison Outcome . . . . .	130
<b>9</b>	<b>The Epsilon Merging Language (EML)</b>	<b>133</b>
9.1	Motivation . . . . .	133
9.1.1	Phases of Model Merging . . . . .	133
9.1.2	Relationship between Model Merging and Model Transformation . . . . .	134
9.2	Realizing a Model Merging Process with Epsilon . . . . .	135
9.3	Abstract Syntax . . . . .	135

9.4	Concrete Syntax . . . . .	135
9.5	Execution Semantics . . . . .	137
9.5.1	Rule and Block Overriding . . . . .	137
9.5.2	Rule Scheduling . . . . .	137
9.5.3	Rule Applicability . . . . .	137
9.5.4	Source Elements Resolution . . . . .	138
9.6	Homogeneous Model Merging Example . . . . .	139
<b>10</b>	<b>Epsilon Flock for Model Migration</b>	<b>145</b>
10.1	Background and Motivation . . . . .	145
10.2	Abstract Syntax . . . . .	147
10.3	Concrete Syntax . . . . .	147
10.4	Execution Semantics . . . . .	149
10.5	Example . . . . .	151
10.6	Limitations and Scope . . . . .	153
10.6.1	Limitations . . . . .	153
10.6.2	Scope . . . . .	154
10.7	Further Reading . . . . .	154
<b>11</b>	<b>The Epsilon Pattern Language (EPL)</b>	<b>155</b>
11.1	Background and Motivation . . . . .	155
11.2	Syntax . . . . .	157
11.2.1	Negative Roles . . . . .	160
11.2.2	Optional and Active Roles . . . . .	160
11.2.3	Role Cardinality . . . . .	160
11.3	Execution Semantics . . . . .	161
11.4	Pattern Matching Output . . . . .	162
11.5	Interoperability with Other Model Management Tasks . . . . .	163
<b>12</b>	<b>The Epsilon Model Generation Language (EMG)</b>	<b>167</b>
12.1	Background and Motivation . . . . .	167
12.1.1	Approaches to Model Generation . . . . .	168
12.2	Syntax . . . . .	168
12.2.1	EMG predefined operations . . . . .	170
12.3	Creating Model Elements . . . . .	174
12.4	Creating Model Links . . . . .	175
12.5	Meaningful Strings . . . . .	176

12.5.1 Values as a parameter . . . . .	177
12.5.2 Values as a model . . . . .	177
<b>13 Implementing a New Task-Specific Language</b>	<b>179</b>
13.1 Identifying the need for a new language . . . . .	179
13.2 Eliciting higher-level constructs from recurring patterns . . . . .	181
13.3 Implement Execution Semantics and Scheduling . . . . .	181
13.4 Overriding Semantics . . . . .	181
<b>14 Orchestration Workflow</b>	<b>183</b>
14.1 Motivation . . . . .	183
14.2 The ANT Tool . . . . .	184
14.2.1 Structure . . . . .	185
14.2.2 Concrete Syntax . . . . .	185
14.2.3 Extending ANT . . . . .	186
14.3 Integration Challenges . . . . .	186
14.4 Framework Design and Core Tasks . . . . .	187
14.4.1 The EpsilonTask task . . . . .	187
14.4.2 Model Loading Tasks . . . . .	190
14.4.3 Model Storing Task . . . . .	191
14.4.4 Model Disposal Tasks . . . . .	191
14.4.5 The StartTransaction Task . . . . .	191
14.4.6 The CommitTransaction and RollbackTransaction Tasks . . . . .	192
14.4.7 The Abstract Executable Module Task . . . . .	193
14.5 Model Management Tasks . . . . .	195
14.5.1 Generic Model Management Task . . . . .	195
14.5.2 Model Validation Task . . . . .	196
14.5.3 Model-to-Model Transformation Task . . . . .	197
14.5.4 Model Comparison Task . . . . .	197
14.5.5 Model Merging Task . . . . .	197
14.5.6 Model-to-Text Transformation Task . . . . .	198
14.5.7 Model Migration Task . . . . .	198
14.5.8 Pattern Matching Task . . . . .	199
14.6 Miscellaneous Tasks . . . . .	199
14.6.1 Java Class Static Method Execution Task . . . . .	199
14.6.2 Adding a new Model Management Task . . . . .	199
14.7 Chapter Summary . . . . .	200



<b>15 The Epsilon Unit Testing Framework (EUnit)</b>	<b>201</b>
15.1 Motivation . . . . .	201
15.1.1 Common Issues . . . . .	202
15.1.2 Testing with JUnit . . . . .	202
15.1.3 Selected Approach . . . . .	203
15.2 Test Organization . . . . .	204
15.2.1 Test Suites . . . . .	204
15.2.2 Test Cases . . . . .	206
15.3 Test Specification . . . . .	207
15.3.1 Ant Buildfile . . . . .	207
15.3.2 EOL script . . . . .	208
15.4 Examples . . . . .	216
15.4.1 Models and Tasks in the Buildfile . . . . .	216
15.4.2 Models and Tasks in the EOL Script . . . . .	217
15.5 Extending EUnit . . . . .	218
15.6 Summary . . . . .	221
<b>Bibliography</b>	<b>223</b>

# List of Figures

2.1	Overview of the Epsilon Model Connectivity layer . . . . .	20
3.1	EOL Module Structure . . . . .	26
3.2	Overview of the type system of EOL . . . . .	31
3.3	Overview of the feature navigation EOL expressions . . . . .	46
3.4	The Tree Metamodel . . . . .	57
3.5	Example of an Eclipse-based IUserInput implementation . . . . .	60
3.6	Example of a command-line-based IUserInput implementation . . . . .	60
4.1	Abstract Syntax of EVL . . . . .	68
4.2	The ProcessLang Metamodel . . . . .	77
4.3	The ProcessPerformanceLang Metamodel . . . . .	78
4.4	Exemplar Process and ProcessPerformance models . . . . .	81
4.5	Screenshot of the validation view reporting the identified inconsistencies . . . . .	82
5.1	ETL Abstract Syntax . . . . .	85
5.2	ETL Runtime . . . . .	88
5.3	A Simple Graph Metamodel . . . . .	90
6.1	EWL Abstract Syntax . . . . .	97
7.1	The abstract syntax of EGL's core. . . . .	106
7.2	Sample output from the traceability API. . . . .	121
8.1	ECL Abstract Syntax . . . . .	125
8.2	ECL Match Trace . . . . .	127
8.3	The Tree Metamodel . . . . .	128
9.1	The Abstract Syntax of EML . . . . .	136
9.2	The EML runtime . . . . .	138

9.3	Left input model	142
9.4	Right input model	142
9.5	Target model derived by merging the models of Figures 9.3 and 9.4	143
10.1	Process-oriented metamodel evolution.	146
10.2	The Abstract Syntax of Flock	148
10.3	Model migration strategy in pseudo code for the metamodel evolution in Figure 10.1.	152
11.1	Simplified view of the MoDisco Java metamodel	156
11.2	Abstract Syntax of EPL	157
11.3	Pattern Matching Output	162
12.1	PetriNet metamodel	174
14.1	Simplified ANT object model	185
14.2	Core Framework	188
14.3	Core Models Framework	189
14.4	Model Management Tasks	196
15.1	Example of an EUnit test tree	205
15.2	Comparison between parametric testing and theories	206
15.3	Screenshot of the EUnit graphical user interface	215

# List of Tables

3.1	Operations of type Any	32
3.2	Operations of type String	35
3.3	Operations of type Real	36
3.4	Operations of type Integer	36
3.5	Operations of type Collection	38
3.6	Operations of types Sequence and OrderedSet	40
3.7	First-order logic operations on Collections	41
3.8	Operations of type Map	42
3.9	Operations of Model Element Types	44
3.10	Arithmetical operators	47
3.11	Comparison operators	47
3.12	Logical Operators	48
3.13	Implies Truth Table	48
3.14	Default values of primitive types	49
3.15	Operations of IUserInput	59
7.1	Operations of type OutputBuffer	109
7.2	Operations of type Template	112
7.3	Operations of the TemplateFactory object	113
7.4	EGL's default merging behaviour.	119
12.1	Emg data generation operations	170
12.2	Operations of type Any	173
15.1	Extra operations and variables in EUnit	211
15.2	Assertions in EUnit	212
15.3	Available options by model comparator	214

# Acknowledgements

The authors would like to express their gratitude to Maarten Bezemer, Chris Holmes, Nikos Matragkas, Fiona Polack, Horacio Hoyos Rodriguez, Alireza Rouhi, Konrad Schwarz, Silvia de la Torre, and James Williams for their comments and contributions to this book.



# Chapter 1

## Introduction

The purpose of this book is to provide a complete reference of the languages provided by the Epsilon project (<http://www.eclipse.org/epsilon>).

### 1.1 What is Epsilon?

Epsilon, standing for Extensible Platform of Integrated Languages for mOdel maNagement, is a platform for building consistent and interoperable task-specific languages for model management tasks such as model transformation, code generation, model comparison, merging, refactoring and validation.

Epsilon currently provides the following languages:

- Epsilon Object Language (EOL)
- Epsilon Validation Language (EVL)
- Epsilon Transformation Language (ETL)
- Epsilon Comparison Language (ECL)
- Epsilon Merging Language (EML)
- Epsilon Wizard Language (EWL)
- Epsilon Generation Language (EGL)
- Epsilon Pattern Language (EPL)

For each language, Epsilon provides Eclipse-based development tools and an interpreter<sup>1</sup> that can execute programs written in this language. Epsilon also provides a set of ANT tasks for creating workflows of different tasks (e.g. a validation followed by a transformation followed by code generation). The following chapters present the syntax of each language and a few usage examples.

## 1.2 How To Read This Book

If you are reading this book, there's a good chance that you are already interested in using a particular task-specific language provided by Epsilon (e.g. EVL for model validation or ETL for model transformation). In this case, you don't have to need to read about all the languages: you should start by spending some time reading Chapter 3 that presents the core Epsilon Object Language (EOL) – as all languages of the platform extend EOL both syntactically and semantically – and you can then proceed directly to the chapter that discusses the particular language you are interested in (e.g. Chapter 4 for EVL).

## 1.3 Questions and Feedback

Our intention is to keep this book a live project that will evolve in parallel with Epsilon. Therefore, your feedback on any omissions, errors or outdated content is critical and much appreciated (and will also earn you a place in the Acknowledgements section of the book). Please send your feedback to the Epsilon forum (see <http://www.eclipse.org/epsilon/forum/> for detailed instructions).

## 1.4 Additional Resources

As mentioned above, information about Epsilon and examples are available in many different places. If you can't find what you are looking for in this book there are a few other places where you may try.

### 1.4.1 Epsilon Website

Epsilon is a component of the Eclipse Modelling project, hosted under <http://www.eclipse.org/epsilon>. In the documentation section <http://www.eclipse.org/>

---

<sup>1</sup>The interpreters are not bound in any way to Eclipse and can also be used in standalone Java applications.



[epsilon/doc](#) of the website you can find examples, articles and screencasts on all tools and languages that Epsilon provides.

## 1.4.2 EpsilonLabs

EpsilonLabs is a satellite project of Epsilon that hosts experimental applications/extensions of Epsilon or other content that cannot be shared under Eclipse.org due to licensing issues (e.g. incompatibility with EPL). EpsilonLabs is hosted at GitHub: <https://github.com/epsilonlabs>

## 1.4.3 Twitter

To keep in touch with the latest news on Epsilon, please follow [@epsilonnews](#) on Twitter.



## Chapter 2

# The Epsilon Model Connectivity Layer (EMC)

This section discusses the design of the Epsilon Model Connectivity (EMC) layer. EMC provides abstraction facilities over concrete modelling technologies such as EMF, XML etc. and enables Epsilon programs to interact with models conforming to these technologies in a uniform manner. A graphical overview of the design is displayed in Figure 2.1.

To abstract away from diverse model representations and APIs provided by different modelling technologies, EMC defines the *IModel* interface. *IModel* provides a number of methods that enable querying and modifying the model elements it contains at a higher level of abstraction. To enable languages and tools that build atop EMC to manage multiple models simultaneously, the *ModelRepository* class acts as a container that offers façade services. The following sections discuss these two core concepts in detail.

### 2.1 The IModel interface

Each model specifies a name which must be unique in the context of the model repository in which it is contained. Also, it defines a number of aliases; that is non-unique alternate names; via which it can be accessed. The interface also defines the following services.

### 2.2 Loading and Persistence

The *load()* and *load(properties : Properties)* methods enable extenders to specify in a uniform way how a model is loaded into memory from the physical location in which it

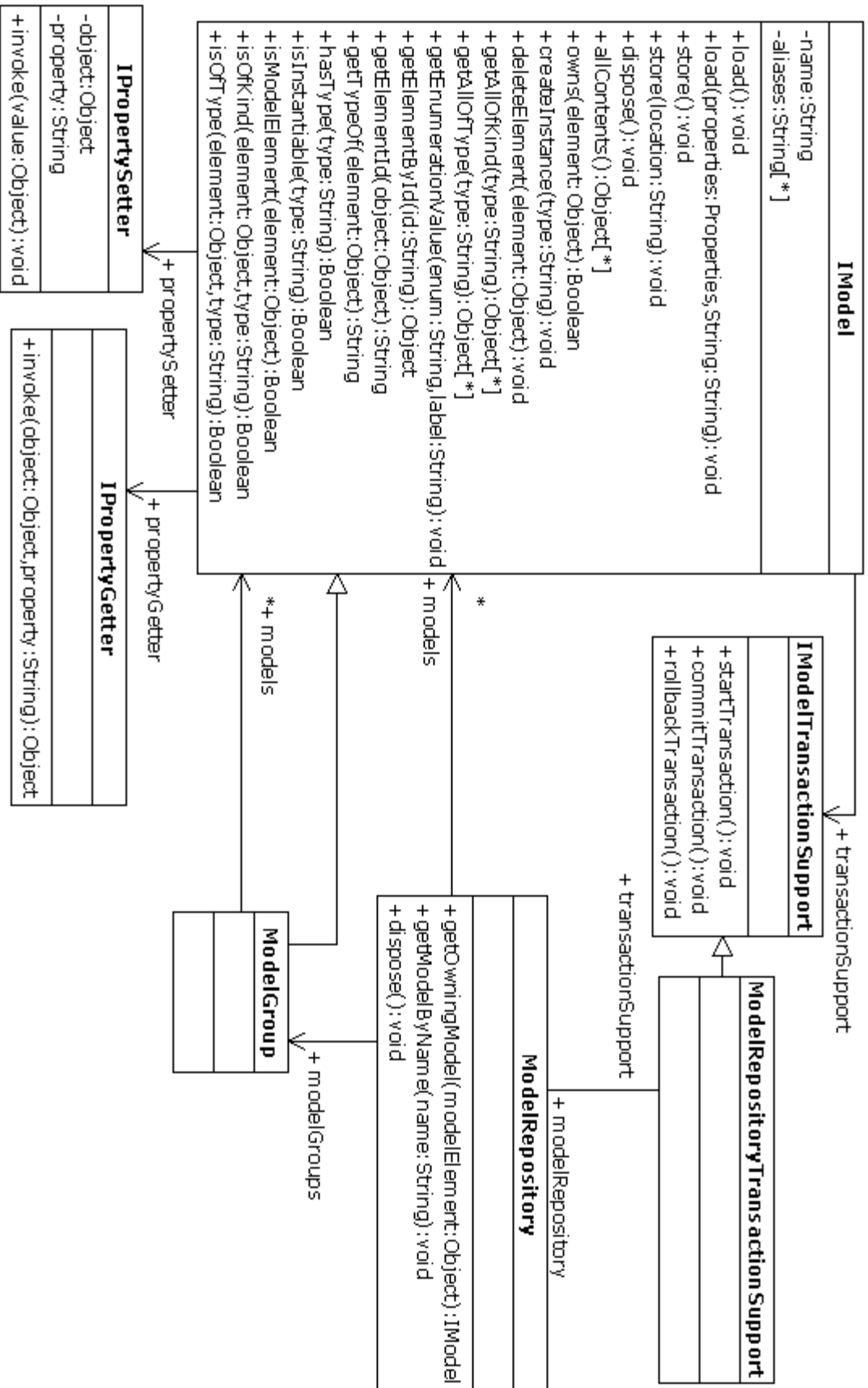

Figure 2.1: Overview of the Epsilon Model Connectivity Layer

resides. Similarly, the *store()* and *store(location : String)* methods are used to define how the model can be persisted from memory to a permanent storage location.

## 2.3 Type-related Services

The majority of metamodeling architectures support inheritance between meta-classes and therefore two types of type-conformance relationships generally appear between model elements and types. The *type-of* relationship appears when a model element is an instance of the type and the *kind-of* relationship appears when the model element is an instance of the type or any of its sub-types. Under this definition, the *getAllOfType( type : String )* and the *getAllOfKind( type : String )* operations return all the elements in the model that have a type-of and a kind-of relationship with the type in question respectively.

Similarly, the *isTypeOf( element : Object, type : String )* and *isKindOf( element : Object, type : String )* return whether the element in question has a type-of or a kind-of relationship with the type respectively. The *getTypeOf( element : Object )* method returns the fully-qualified name of the type an element conforms to.

The *hasType( type : String )* method returns true if the model supports a type with the specified name. To support technologies that enable users to define abstract (non-instantiable) types, the *isInstantiable( type : String )* method returns if instances of the type can be created.

## 2.4 Ownership

The *allContents()* method returns all the elements that the model contains and the *owns( element : Object )* method returns true if the element under question belongs to the model.

## 2.5 Creation, Deletion and Modifications

Model elements are created and deleted using the *createInstance( type : String )* and *deleteElement( element : Object )* methods respectively.

To retrieve and set the values of properties of its model elements, *IModel* uses its associated *propertyGetter (IPropertyGetter)* and *propertySetter (IPropertySetter)* respectively. Technology-specific implementations of those two interfaces are responsible for accessing and modifying the value of a property of a model element through their *invoke( element : Object, property : String )* and *invoke( value : Object )* respectively.

## 2.6 The *IModelTransactionSupport* interface

In its *transactionSupport* property, a model can optionally (if the target modelling technology supports transactions) specify an instance of an implementation of the *IModelTransactionSupport* interface. The interface provides transaction-related services for the specific modelling technology. The interface provides the *startTransaction()*, *commitTransaction()* and *rollbackTransaction()* methods that start a new transaction, commit and roll back the current transaction respectively.

## 2.7 The *ModelRepository* class

A model repository acts as a container for a set of models that need to be managed in the context of a task or a set of tasks. Apart from a reference to the models it contains, *ModelRepository* also provides the following façade functionality.

The *getOwningModel( element : Object )* method returns the model that owns a particular element. The *transactionSupport* property specifies an instance of the *ModelRepositoryTransactionSupport* class which is responsible for aggregate management of transactions by delegating calls to its *startTransaction()*, *commitTransaction()* and *abortTransaction()* methods, to the respective methods of instances of *IModelTransactionSupport* associated with models contained in the repository.

## 2.8 The *ModelGroup* class

A *ModelGroup* is a group of models that have a common alias. *ModelGroups* are calculated dynamically by the model repository based on common model aliases. That is, if two or more models share a common alias, the repository forms a new model group. Since *ModelGroup* implements the *IModel* interface, clients can use all the methods of *IModel* to perform aggregate operations on multiple models, such as collecting the contents of more than one models. An exception to that is the *createInstance( type : String )* method which cannot be defined for a group of models as it cannot be determined in which model of the group the newly created element should belong.

## 2.9 Assumptions about the underlying modelling technologies

The discussion provided above has demonstrated that EMC makes only minimal assumptions about the structure and the organization of the underlying modelling technologies. Thus, it intentionally refrains from defining classes for concepts such as *model element*, *type* and *metamodel*. By contrast, it employs a lightweight approach that uses primitive strings for type names and objects of the target implementation platforms as model elements. There are two reasons for this decision.

The primary reason is that by minimizing the assumptions about the underlying technologies EMC becomes more resistant to future changes of the implementations of the current technologies and can also embrace new technologies without changes.

Another reason is that if a heavy-weight approach was used, extending the platform with support for a new modelling technology would involve providing wrapping objects for the native objects which represent model elements and types in the specific modelling technology. Experiments in the early phases of the design of EMC demonstrated that such a heavy-weight approach significantly increases the amount of memory required to represent the models in memory, degrades performance and provides little benefits in reward<sup>1</sup>.

---

<sup>1</sup>Recent developments in the context of the ATL transformation language have also demonstrated significant performance gains delivered by using native model element representations. Relevant benchmarks can be found [http://wiki.eclipse.org/ATL\\_VM\\_Testing](http://wiki.eclipse.org/ATL_VM_Testing)





# Chapter 3

## The Epsilon Object Language (EOL)

The primary aim of EOL is to provide a reusable set of common model management facilities, atop which task-specific languages can be implemented. However, EOL can also be used as a general-purpose standalone model management language for automating tasks that do not fall into the patterns targeted by task-specific languages. This section presents the syntax and semantics of the language using a combination of abstract syntax diagrams, concrete syntax examples and informal discussion.

### 3.1 Module Organization

In this section the syntax of EOL is presented in a top-down manner. As displayed in Figure 3.1, EOL programs are organized in *modules*. Each module defines a *body* and a number of *operations*. The body is a block of statements that are evaluated when the module is executed<sup>1</sup>. Each operation defines the kind of objects on which it is applicable (*context*), a *name*, a set of *parameters* and optionally a *return type*. Modules can also import other modules using *import* statements and access their operations, as shown in Listing 3.1.

---

<sup>1</sup>Although the EOL parser permits loose statements (e.g. not contained in operations) between/after operations, these are ignored at runtime.

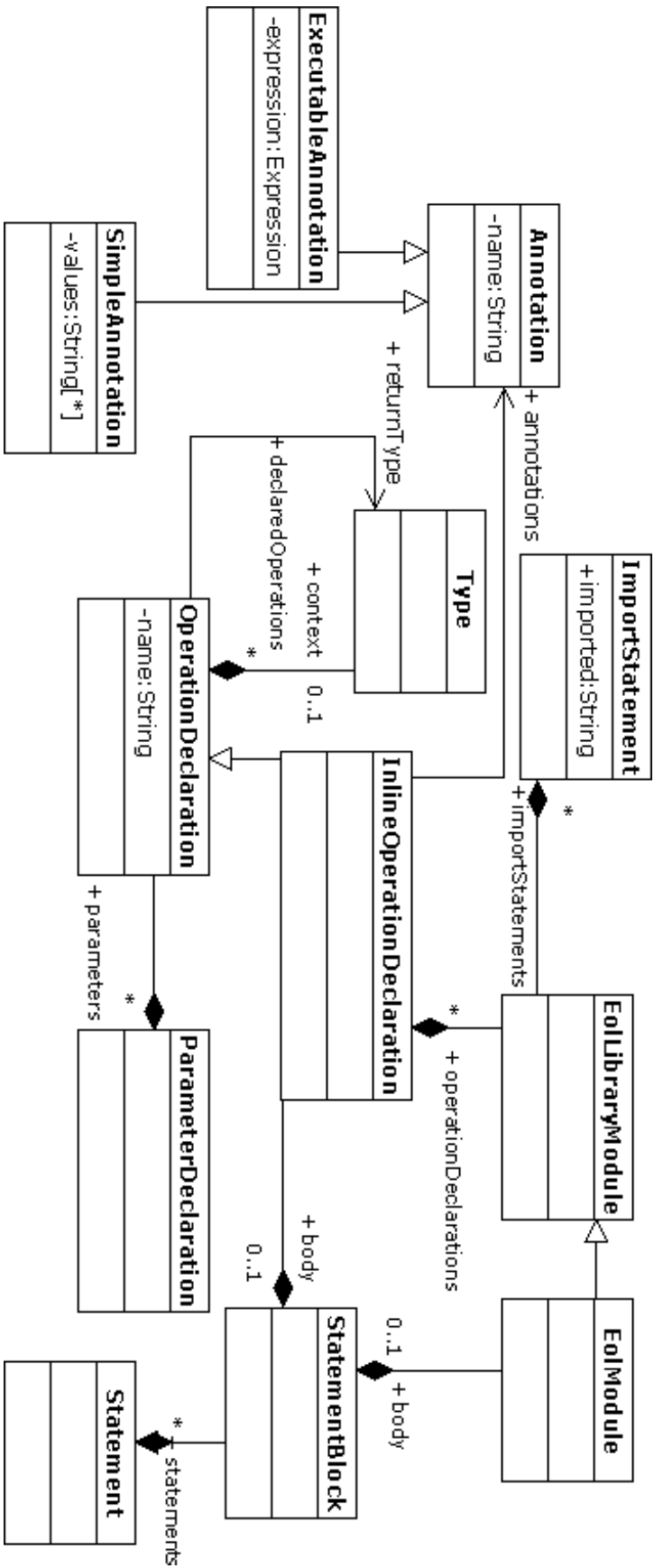

Figure 3.1: EOL Module Structure

```

1 // file imported.eol
2 operation hello() {
3 'Hello world!'.println();
4 }
5
6 // file importer.eol
7 // We can use relative/absolute paths or platform:/ URIs
8 import "imported.eol";
9
10 hello(); // main body
11
12 // ... more operations could be placed here ...

```

Listing 3.1: Example of two related EOL modules

## 3.2 User-Defined Operations

In typical object oriented languages such as Java and C++, operations are defined inside classes and can be invoked on instances of those classes. EOL on the other hand is not object-oriented in the sense that it does not define classes itself, but nevertheless needs to manage objects of types defined externally to it (e.g. in metamodels). By defining the context-type of an operation explicitly, the operation can be called on instances of the type as if it was natively defined by the type. Alternatively, context-less operations could be defined; however the adopted technique significantly improves readability of the concrete syntax.

```

1 1.add1().add2().println();
2
3 operation Integer add1() : Integer {
4 return self + 1;
5 }
6
7 operation Integer add2() : Integer {
8 return self + 2;
9 }

```

Listing 3.2: Context-defining EOL operations

For example, consider the code excerpts displayed in Listings 3.2 and 3.3. In Listing 3.2, the operations *add1* and *add2* are defined in the context of the built-in *Integer* type, which is specified before their names. Therefore, they can be invoked in line 1 using the *1.add1().add2()* expression: the context (the integer *1*) will be assigned to the special variable *self*. On the other hand, in Listing 3.3 where no context is defined, they have to be invoked in a nested manner which follows an in-to-out direction instead of the left to right direction used by the former excerpt. As complex model queries often involve invoking

multiple properties and operations, this technique is particularly beneficial to the overall readability of the code.

```
1 add2(add1(1)).println();
2
3 operation add1(base : Integer) : Integer {
4     return base + 1;
5 }
6
7 operation add2(base : Integer) : Integer {
8     return base + 2;
9 }
```

Listing 3.3: Context-less EOL operations

EOL supports polymorphic operations using a runtime dispatch mechanism. Multiple operations with the same name and parameters can be defined, each defining a distinct context type. For example, in Listing 3.4, the statement in line 1 invokes the test operation defined in line 4, while the statement in line 2 invokes the test operation defined in line 8.

```
1 "1".test();
2 1.test();
3
4 operation String test() {
5     (self + " is a string").println();
6 }
7
8 operation Integer test() {
9     (self + "is an integer").println();
10 }
```

Listing 3.4: Demonstration of polymorphism in EOL

### 3.2.1 Annotations

EOL supports two types of annotations: simple and executable. A simple annotation specifies a name and a set of String values while an executable annotation specifies a name and an expression. The concrete syntaxes of simple and executable annotations are displayed in Listings 3.5 and 3.6 respectively. Several examples for simple annotations are shown in Listing 3.7. Examples for executable annotations will be given in the following sections.

In stand-alone EOL, annotations are supported only in the context of operations, however as discussed in the sequel, task-specific languages also make use of annotations in their constructs, each with task-specific semantics. EOL operations support three partic-

ular annotations: the *pre* and *post* executable annotations for specifying pre and post-conditions, and the *cached* simple annotation, which are discussed below.

```
1 @name value(,value)*
```

Listing 3.5: Concrete syntax of simple annotations

```
1 $name expression
```

Listing 3.6: Concrete syntax of executable annotations

```
1 @colors red
2 @colors red, blue
3 @colors red, blue, green
```

Listing 3.7: Examples of simple annotations

### 3.2.2 Pre/post conditions in user-defined operations

A number of *pre* and *post* executable annotations can be attached to EOL operations to specify the pre- and post-conditions of the operation. When an operation is invoked, before its body is evaluated, the expressions of the *pre* annotations are evaluated. If all of them return *true*, the body of the operation is processed, otherwise, an error is raised. Similarly, once the body of the operation has been executed, the expressions of the *post* annotations of the operation are executed to ensure that the operation has had the desired effects. *Pre* and *post* annotations can access all the variables in the parent scope, as well as the parameters of the operation and the object on which the operation is invoked (through the *self* variable). Moreover, in *post* annotations, the returned value of the operation is accessible through the built-in *\_result* variable. An example of using pre and post conditions in EOL appears in Listing 3.8.

In line 4 the *add* operation defines a pre-condition stating that the parameter *i* must be a positive number. In line 5, the operation defines that result of the operation (*\_result*) must be greater than the number on which it was invoked (*self*). Thus, when executed in the context of the statement in line 1 the operation succeeds, while when executed in the context of the statement in line 2, the pre-condition is not satisfied and an error is raised.

```

1 1.add(2);
2 1.add(-1);
3
4 $pre i > 0
5 $post _result > self
6 operation Integer add(i : Integer) : Integer {
7     return self + i;
8 }

```

Listing 3.8: Example of pre- and post-conditions in an EOL operation

### 3.2.3 Operation Result Caching

EOL supports caching the results of parameter-less operations using the *@cached* simple annotation. In the following example, the Fibonacci number of a given Integer is calculated using the *fibonacci* recursive operation displayed in Listing 3.9. Since the *fibonacci* operation is declared as *cached*, it is only executed once for each distinct Integer and subsequent calls on the same target return the cached result. Therefore, when invoked in line 1, the body of the operation is called 16 times. By contrast, if no *@cached* annotation was specified, the body of the operation would be called recursively 1973 times. This feature is particularly useful for performing queries on large models and caching their results without needing to introduce explicit variables that store the cached results.

It is worth noting that caching works *by reference*, which means that all clients of a cached method for a given context will receive the same returned object. As such, if the first client modifies the returned object in some way (e.g. sets a property in the case of an object or adds an element in the case of the collection), subsequent clients of the method for the same context will receive the modified object/collection.

```

1 15.fibonacci().println();
2
3 @cached
4 operation Integer fibonacci() : Integer {
5     if (self = 1 or self = 0) {
6         return 1;
7     }
8     else {
9         return (self-1).fibonacci() + (self-2).fibonacci();
10    }
11 }

```

Listing 3.9: Calculating the Fibonacci number using a cached operation

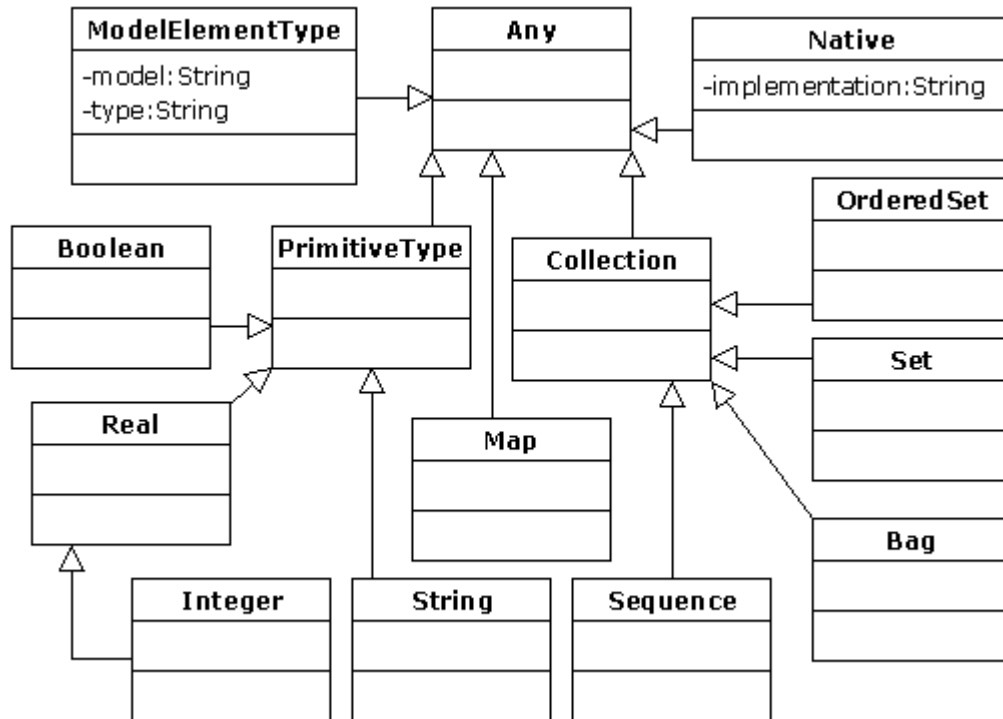

Figure 3.2: Overview of the type system of EOL

### 3.3 Types

As is the case for most programming languages, EOL defines a built-in system of types, illustrated in Figure 3.2. The *Any* type, inspired by the *OclAny* type of OCL, is the basis of all types in EOL including Collection types. The operations supported by instances of the *Any* type are outlined in Table 3.1<sup>2</sup>.

<sup>2</sup>Parameters within square braces [ ] are optional

Table 3.1: Operations of type Any

Signature	Description
asBag() : Bag	Returns a new Bag containing the object
asBoolean() : Boolean	Returns a Boolean based on the string representation of the object. If the string representation is not of an acceptable format, an error is raised
asInteger() : Integer	Returns an Integer based on the string representation of the object. If the string representation is not of an acceptable format, an error is raised
asOrderedSet() : OrderedSet	Returns a new OrderedSet containing the object
asReal() : Real	Returns a Real based on the string representation of the object. If the string representation is not of an acceptable format, an error is raised
asDouble() : Double	Returns a Java Double based on the string representation of the object. If the string representation is not of an acceptable format, an error is raised
asFloat() : Float	Returns a Java Float based on the string representation of the object. If the string representation is not of an acceptable format, an error is raised
asSequence() : Sequence	Returns a new Sequence containing the object
asSet() : Set	Returns a new Set containing the object
asString() : String	Returns a string representation of the object
err([prefix : String]) : Any	Prints a string representation of the object on which it is invoked to the error stream prefixed with the optional <i>prefix</i> string and returns the object on which it was invoked. In this way, the <i>err</i> operation can be used for debugging purposes in a non-invasive manner
errln([prefix : String]) : Any	Has the same effects as the <i>err</i> operation but also produces a new line in the output stream.



<code>format([pattern : String]) : String</code>	Uses the provided pattern to form a String representation of the object on which the method is invoked. The pattern argument must conform to the format string syntax defined by Java <sup>3</sup> .
<code>hasProperty(name : String) : Boolean</code>	Returns true if the object has a property with the specified name or false otherwise
<code>ifUndefined(alt : Any) : Any</code>	If the object is undefined, it returns alt else it returns the object
<code>isDefined() : Boolean</code>	Returns true if the object is defined and false otherwise
<code>isKindOf(type : Type) : Boolean</code>	Returns true if the object is of the given type or one of its subtypes and false otherwise
<code>isTypeOf(type : Type) : Boolean</code>	Returns true if the object is of the given type and false otherwise
<code>isUndefined() : Boolean</code>	Returns true if the object is undefined and false otherwise
<code>owningModel() : Model</code>	Returns the model that contains this object or an undefined value otherwise
<code>print([prefix : String]) : Any</code>	Prints a string representation of the object on which it is invoked to the regular output stream, prefixed with the optional <i>prefix</i> string and returns the object on which it was invoked. In this way, the <i>print</i> operation can be used for debugging purposes in a non-invasive manner
<code>println([prefix : String]) : Any</code>	Has the same effects as the <i>print</i> operation but also produces a new line in the output stream.
<code>type() : Type</code>	Returns the type of the object. The EOL type system is illustrated in Figure 3.2

---

<sup>3</sup><http://download.oracle.com/javase/6/docs/api/java/util/Formatter.html#syntax>

### **3.3.1 Primitive Types**

EOL provides four primitive types: String, Integer, Real and Boolean. The String type represents finite sequences of characters and supports the following operations which can be invoked on its instances.

Table 3.2: Operations of type String

Signature	Description
characterAt(index : Integer) : String	Returns the character in the specified index
concat(str : String) : String	Returns a concatenated form of the string with the <i>str</i> parameter
endsWith(str : String) : Boolean	Returns true iff the string ends with <i>str</i>
firstToLowerCase() : String	Returns a new string the first character of which has been converted to lower case
firstToUpperCase() : String	Returns a new string, the first character of which has been converted to upper case
isInteger() : Boolean	Returns true iff the string is an integer
isReal() : Boolean	Returns true iff the string is a real number
isSubstringOf(str : String) : Boolean	Returns true iff the string the operation is invoked on is a substring of <i>str</i>
length() : Integer	Returns the number of characters in the string
matches(reg : String) : Boolean	Returns true if there are occurrences of the regular expression <i>reg</i> in the string
pad(length : Integer, padding : String, right : Boolean) : String	Pads the string up to the specified length with specified padding (e.g. "foo".pad(5, "*", true) returns "foo***")
replace(source : String, target : String) : String	Returns a new string in which all instances of <i>source</i> have been replaced with instances of <i>target</i>
split(reg : String) : Sequence(String)	Splits the string using as a delimiter the provided regular expression, <i>reg</i> , and returns a sequence containing the parts
startsWith(str : String) : Boolean	Returns true iff the string starts with <i>str</i>
substring(index : Integer) : String	Returns a sub-string of the string starting from the specified <i>index</i> and extending to the end of the original string

substring(startIndex : Integer, endIndex : Integer) : String	Returns a sub-string of the string starting from the specified <i>startIndex</i> and ending at <i>endIndex</i>
toCharSequence() : Sequence(String)	Returns a sequence containing all the characters of the string
toLowerCase() : String	Returns a new string where all the characters have been converted to lower case
toUpperCase() : String	Returns a new string where all the characters have been converted to upper case
trim() : String	Returns a trimmed copy of the string

The Real type represents real numbers and provides the following operations.

Table 3.3: Operations of type Real

Signature	Description
abs() : Real	Returns the absolute value of the real
ceiling() : Integer	Returns the nearest Integer that is greater than the real
floor() : Integer	Returns the nearest Integer that is less than the real
log() : Real	Returns the natural logarithm of the real
log10() : Real	Returns the 10-based logarithm of the real
max(other : Real) : Real	Returns the maximum of the two reals
min(other : Real) : Real	Returns the minimum of the two reals
pow(exponent : Real) : Real	Returns the real to the power of exponent
round() : Integer	Rounds the real to the nearest Integer

The Integer type represents natural numbers and negatives and extends the Real primitive type. It also defines the following operations:

Table 3.4: Operations of type Integer

Signature	Description
<code>iota(end : Integer, step : Integer) : Sequence(Integer)</code>	Returns a sequence of integers up to <i>end</i> using the specified step (e.g. <code>1.iota(10,2)</code> returns <code>Sequence{1,3,5,7,9}</code> )
<code>mod(divisor : Integer) : Integer</code>	Returns the remainder of dividing the integer by the divisor
<code>to(other : Integer) : Sequence(Integer)</code>	Returns a sequence of integers (e.g. <code>1.to(5)</code> returns <code>Sequence{1,2,3,4,5}</code> )
<code>toBinary() : String</code>	Returns the binary representation of the integer (e.g. <code>6.toBinary()</code> returns <code>"110"</code> )
<code>toHex() : String</code>	Returns the hexadecimal representation of the integer (e.g. <code>42.toBinary()</code> returns <code>"2a"</code> )

Finally, the Boolean type represents true/false states and provides no additional operations to those provided by the base Any type.

### 3.3.2 Collections and Maps

EOL provides four types of collections and a Map type. The Bag type represents non-unique, unordered collections, the Sequence type represents non-unique, ordered collections, the Set type represents unique and unordered collections and the OrderedSet represents unique and ordered collections.

All collection types inherit from the abstract Collection type. Apart from simple operations, EOL also supports first-order logic operations on collections. The following operations apply to all types of collections:

Table 3.5: Operations of type Collection

Signature	Description
<code>add(item : Any) : Boolean</code>	Adds an item to the collection. If the collection is a set, addition of duplicate items has no effect. Returns true if the collection increased in size: this is always the case for bags and sequences, and for sets and ordered sets it is true if the element was not part of the collection before.
<code>addAll(col : Collection) : Boolean</code>	Adds all the items of the <i>col</i> argument to the collection. If the collection is a set, it only adds items that do not already exist in the collection. Returns true if this collection changed as a result of the call
<code>asBag()</code>	Returns a Bag that contains the same elements as the collection.
<code>asOrderedSet()</code>	Returns a duplicate-free OrderedSet that contains the same elements as the collection.
<code>asSequence()</code>	Returns a Sequence that contains the same elements as the collection.
<code>asSet()</code>	Returns a duplicate-free Set that contains the same elements as the collection.
<code>clear()</code>	Empties the collection
<code>clone() : Collection</code>	Returns a new collection of the same type containing the same items with the original collection
<code>concat() : String</code>	Returns the string created by converting each element of the collection to a string
<code>concat(separator : String) : String</code>	Returns the string created by converting each element of the collection to a string, using the given argument as a separator
<code>count(item : Any) : Integer</code>	Returns the number of times the item exists in the collection
<code>excludes(item : Any) : Boolean</code>	Returns true if the collection excludes the <i>item</i>

excludesAll(col : Collection) : Boolean	Returns true if the collection excludes all the items of collection <i>col</i>
excluding(item : Any) : Collection	Returns a new collection that excludes the item – unlike the remove() operation that removes the <i>item</i> from the collection itself
excludingAll(col : Collection) : Collection	Returns a new collection that excludes all the elements of the <i>col</i> collection
flatten() : Collection	Recursively flattens all items that are of collection type and returns a new collection where no item is a collection itself
includes(item : Any) : Boolean	Returns true if the collection includes the <i>item</i>
includesAll(col : Collection) : Boolean	Returns true if the collection includes all the items of collection <i>col</i>
including(item : Any) : Collection	Returns a new collection that also contains the <i>item</i> – unlike the add() operation that adds the <i>item</i> to the collection itself
includingAll(col : Collection) : Collection	Returns a new collection that is a union of the two collections. The type of the returned collection (i.e. Bag, Sequence, Set, OrderedSet) is same as the type of the collection on which the operation is invoked
isEmpty() : Boolean	Returns true if the collection does not contain any elements and false otherwise
min() : Real	Returns the minimum of all reals/integers in the collection, or 0 if it is empty
min(default : Real) : Real	Returns the minimum of all reals/integers in the collection, or the default value if it is empty
max() : Real	Returns the maximum of all reals/integers in the collection, or 0 if it is empty
max(default : Real) : Real	Returns the maximum of all reals/integers in the collection, or the default value if it is empty

notEmpty() : Boolean	Returns true if the collection contains any elements and false otherwise
powerset() : Set	Returns the set of all subsets of the collection
product() : Real	Returns the product of all reals/integers in the collection
random() : Any	Returns a random item from the collection
remove(item : Any) : Boolean	Removes an <i>item</i> from the collection. Returns true if the collection contained the specified element
removeAll(col : Collection) : Boolean	Removes all the items of <i>col</i> from the collection. Returns true if the collection changed as a result of the call
size() : Integer	Returns the number of items the collection contains
sum() : Real	Returns the sum of all reals/integers in the collection

The following operations apply to ordered collection types (i.e. Sequence and Ordered-Set):

Table 3.6: Operations of types Sequence and Ordered-Set

<b>Signature</b>	<b>Description</b>
at(index : Integer) : Any	Returns the item of the collection at the specified index
first() : Any	Returns the first item of the collection
fourth() : Any	Returns the fourth item of the collection
indexOf(item : Any) : Integer	Returns the index of the item in the collection or -1 if it does not exist
invert() : Collection	Returns an inverted copy of the collection
last() : Any	Returns the last item of the collection
removeAt(index : Integer) : Any	Removes and returns the item at the specified index.



second() : Any	Returns the second item of the collection
third() : Any	Returns the third item of the collection

Also, EOL collections support the following first-order operations:

Table 3.7: First-order logic operations on Collections

Signature	Description
aggregate(iterator : Type   keyExpression, valueExpression) : Map	Returns a map containing key-value pairs produced by evaluating the key and value expressions on each item of the collection that is of the specified type
closure(iterator : Type   expression) : Collection	Returns a collection containing the results of evaluating the transitive closure of the results produced by the expression on each item of the collection that is of the specified type. For example, if <i>t</i> is a tree model element, <i>t.closure(it it.children)</i> will return all its descendants
collect(iterator : Type   expression) : Collection	Returns a collection containing the results of evaluating the expression on each item of the collection that is of the specified type
exists(iterator : Type   condition) : Boolean	Returns true if there exists at least one item in the collection that satisfies the condition
forall(iterator : Type   condition) : Boolean	Returns true if all items in the collection satisfy the condition
one(iterator : Type   condition) : Boolean	Returns true if there exists exactly one item in the collection that satisfies the condition
reject(iterator : Type   condition) : Collection	Returns a sub-collection containing only items of the specified type that do not satisfy the condition
select(iterator : Type   condition) : Collection	Returns a sub-collection containing only items of the specified type that satisfy the condition
selectOne(iterator : Type   condition) : Any	Returns the first element that satisfies the condition

sortBy(iterator: Type   expression) : Collection	Returns a copy of the collection sorted by the results of evaluating the expression on each item of the collection that conforms to the iterator type. The expression should return either an Integer, a String or an object that is an instance of Comparable. The ordering is calculated as follows: for integers, smaller to greater; for Strings, as defined by the compareTo method of Java strings; for Comparable objects, according to the semantics of the type's compareTo method implementation.
-----------------------------------------------------	-------------------------------------------------------------------------------------------------------------------------------------------------------------------------------------------------------------------------------------------------------------------------------------------------------------------------------------------------------------------------------------------------------------------------------------------------------------------------------------------------------------

The Map type represents an array of key-value pairs in which the keys are unique. The type provides the following operations.

Table 3.8: Operations of type Map

Signature	Description
clear()	Clears the map
containsKey(key : Any) : Boolean	Returns true if the map contains the specified key
containsValue(value : Any) : Boolean	Returns true if this map maps one or more keys to the specified value.
get(key : Any) : Any	Returns the value for the specified key
isEmpty() : Boolean	Returns true if the map contains no key-value mappings.
keySet() : Set	Returns the keys of the map
put(key : Any, value : Any)	Adds the key-value pair to the map. If the map already contains the same key, the value is overwritten
putAll(map : Map)	Copies all of the mappings from the specified map to this map.

<code>remove(key : Any) : Any</code>	Removes the mapping for the specified key from this map if present. Returns the previous value associated with key.
<code>size() : Integer</code>	Returns the number of key-value mappings in this map.
<code>values() : Bag</code>	Returns the values of the map

### 3.3.3 Native Types

As discussed earlier, while the purpose of EOL is to provide significant expressive power to enable users to manage models at a high level of abstraction, it is not intended to be a general-purpose programming language. Therefore, there may be cases where users need to implement some functionality that is either not efficiently supported by the EOL runtime (e.g. complex mathematical computations) or that EOL does not support at all (e.g. developing user interfaces, accessing databases). To overcome this problem, EOL enables users to create objects of the underlying programming environment by using *native* types. A native type specifies an *implementation* property that indicates the unique identifier for an underlying platform type. For instance, in a Java implementation of EOL the user can instantiate and use a Java class via its class identifier. Thus, in Listing 3.10 the EOL excerpt creates a Java window (Swing JFrame) and uses its methods to change its title and dimensions and make it visible.

To pass arguments to the constructor of a native type, a parameter list must be added, such as that in Listing 3.11.

```
1 var frame = new Native("javax.swing.JFrame");
2 frame.title = "Opened with EOL";
3 frame.setBounds(100,100,300,200);
4 frame.visible = true;
```

Listing 3.10: Demonstration of NativeType in EOL

```
1 var file = new Native("java.io.File")("myfile.txt");
2 file.absolutePath.println();
```

Listing 3.11: Demonstration of NativeType in EOL

### 3.3.4 Model Element Types

A model element type represents a meta-level classifier. As discussed in Section 2, Epsilon intentionally refrains from defining more details about the meaning of a model element type to be able to support diverse modelling technologies where a type has different semantics. For instance a MOF class, an XSD complex type and a Java class can all be regarded as model element types according to the implementation of the underlying modelling framework.

In case of multiple models, as well as the name of the type, the name of the model is also required to resolve a particular type since different models may contain elements of homonymous but different model element types. In case a model defines more than one type with the same name (e.g. in different packages), a fully qualified type name must be provided.

In terms of concrete syntax, inspired by ATL, the ! character is used to separate the name of the type from the name of the model it is defined in. For instance *Ma!A* represents the type *A* of model *Ma*. Also, to support modelling technologies that provide hierarchical grouping of types (e.g. using packages) the :: notation is used to separate between packages and classes. A model element type supports the following operations:

Table 3.9: Operations of Model Element Types

Signature	Description
<code>all() : Set</code>	Alias for <code>allOfKind()</code> (for syntax-compactness purposes)
<code>allInstances() : Set</code>	Alias for <code>allOfKind()</code> (for compatibility with OCL)
<code>allOfKind() : Set</code>	Returns all the elements in the model that are instances either of the type itself or of one of its subtypes
<code>allOfType() : Set</code>	Returns all the elements in the model that are instances of the type
<code>createInstance() : Any</code>	Creates an instance of the type in the model
<code>isInstantiable() : Boolean</code>	Returns true if the type is instantiable (i.e. non-abstract)

As an example of the concrete syntax, Listing 3.12 retrieves all the instances of the Class type (including instances of its subtypes) defined in the Core package of the UML

1.4 metamodel that are contained in the model named UML14.

```
1 UML14!Core::Foundation::Class.allInstances();
```

Listing 3.12: Demonstration of the concrete syntax for accessing model element types

## 3.4 Expressions

### 3.4.1 Literal Values

EOL provides special syntax constructs to create instances of each of the built-in types:

**Integer** literals are defined by using one or more decimal digits (such as *42* or *999*).

Optionally, long integers (with the same precision as a Java *Long*) can be produced by adding a “l” suffix, such as *42l*.

**Real** literals are defined by:

- Adding a decimal separator and non-empty fractional part to the integer part, such as *42.0* or *3.14*. Please note that *.2* and *2.* are *not* valid literals.
- Adding a floating point suffix: “f” and “F” denote single precision, and “d” and “D” denote double precision. For example, *2f* or *3D*.
- Adding an exponent, such as *2e+1* (equal to *2e1*) or *2e-1*.
- Using any combination of the above options.

**String** literals are sequences of characters delimited by single (*'hi'*) or double (*"hi"*) quotes. Quotes inside the string can be escaped by using a backslash, such as in *'A\'s'* or *"A\"s"*. Literal backslashes need to be escaped as well, such as in *'A\\B'*. Special escape sequences are also provided: *\n* for a newline, *\t* for a horizontal tab and *\r* for a carriage return, among others.

**Boolean** literals use the *true* reserved keyword for the true Boolean value, and *false* reserved keyword for the false Boolean value.

**Sequence** and most other collections (except *Maps*) also have literals. Their format is *T {e}*, where *T* is the name of the type and *e* are zero or more elements, separated by commas. For instance, *Sequence {}* is the empty sequence, and *Set {1, 2, 3}* is the set of numbers between 1 and 3.

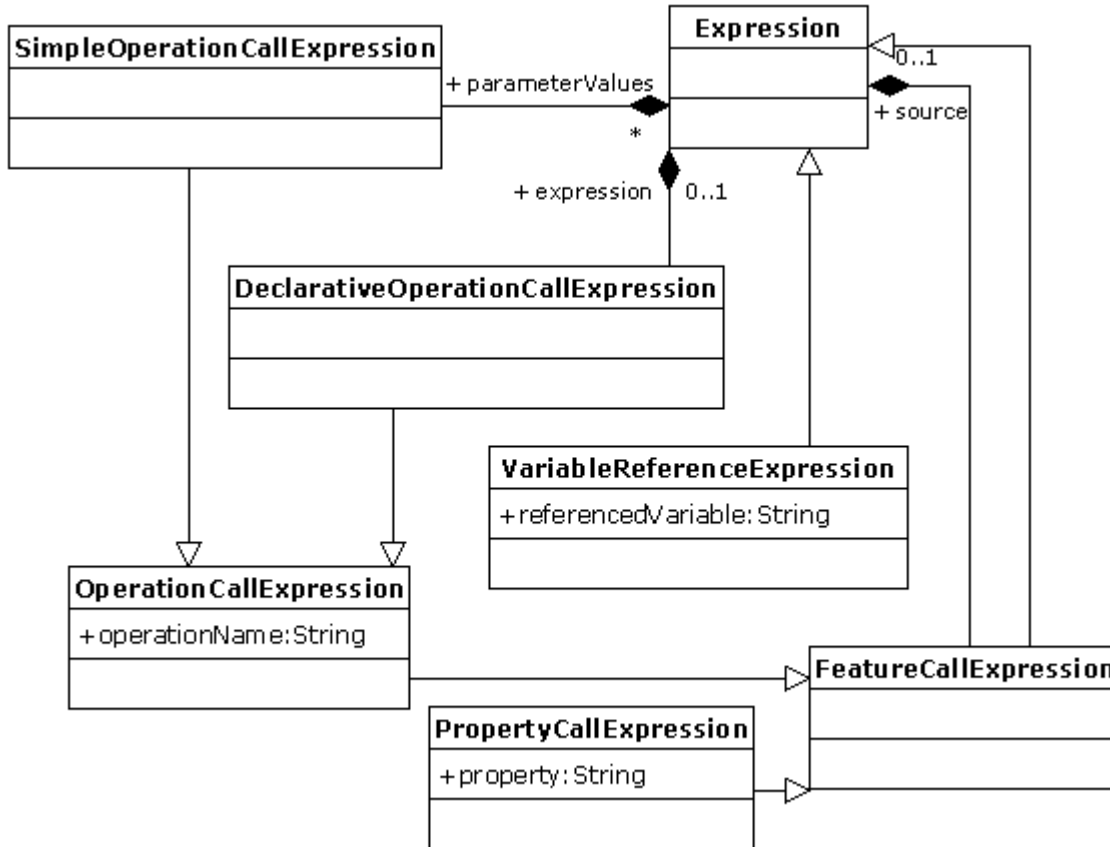

Figure 3.3: Overview of the feature navigation EOL expressions

**Map** literals are similar to the sequential collection literals, but their elements are of the form *key = value*. For instance, *Map { 'a' = 1, 'b' = 2 }* is a map which has two keys, “a” and “b”, which map to the integer values 1 and 2, respectively.

Please note that, when defining an element such as  $1 = 2 = 3$ , the key would be 1 and the value would be the result of evaluating  $2 = 3$  (false). If you would like to use the result of the expression  $1 = 2$  as key, you will need to enclose it in parenthesis, such as in  $(1 = 2) = 3$ .

### 3.4.2 Feature Navigation

Since EOL needs to manage models defined using object oriented modelling technologies, it provides expressions to navigate properties and invoke simple and declarative operations on objects (as presented in Figure 3.3).

In terms of concrete syntax, ‘.’ is used as a uniform operator to access a property of an object and to invoke an operation on it. The ‘→’ operator, which is used in OCL to

```

1 "Something".println();
2
3 operation Any println() : Any {
4   ("Printing : " + self)->println();
5 }

```

Listing 3.13: Invoking operations using EOL

invoke first-order logic operations on sets, has been also preserved for syntax compatibility reasons. In EOL, every operation can be invoked both using the ‘.’ or the ‘→’ operators, with a slightly different semantics to enable overriding the built-in operations. If the ‘.’ operator is used, precedence is given to the user-defined operations, otherwise precedence is given to the built-in operations. For instance, the Any type defines a println() method that prints the string representation of an object to the standard output stream. In Listing 3.13, the user has defined another parameterless println() operation in the context of Any. Therefore the call to println() in Line 1 will be dispatched to the user-defined println() operation defined in line 3. In its body the operation uses the ‘→’ operator to invoke the built-in println() operation (line 4).

### 3.4.3 Arithmetical and Comparison Operators

EOL provides common operators for performing arithmetical computations and comparisons illustrated in Tables 3.10 and 3.11 respectively.

Table 3.10: Arithmetical operators

Operator	Description
+	Adds reals/integers and concatenates strings
-	Subtracts reals/integers
- (unary)	Returns the negative of a real/integer
*	Multiplies reals/integers
/	Divides reals/integers
+ =	Adds the r-value to the l-value
- =	Subtracts the r-value from the l-value
* =	Multiplies the l-value by the r-value
/ =	Divides the l-value by the r-value

Table 3.11: Comparison operators

Operator	Description
----------	-------------

=	Returns true if the left hand side equals the right hand side. In the case of primitive types (String, Boolean, Integer, Real) the operator compares the values; in the case of objects it returns true if the two expressions evaluate to the same object
<>	Is the logical negation of the (=) operator
>	For reals/integers returns true if the left hand side is greater than the right hand side number
<	For reals/integers returns true if the left hand side is less than the right hand side number
>=	For reals/integers returns true if the left hand side is greater or equal to the right hand side number
<=	For reals/integers returns true if the left hand side is less or equal to then right hand side number

### 3.4.4 Logical Operators

EOL provides common operators for performing logical computations illustrated in Table 3.12. Logical operations apply only to instances of the Boolean primitive type.

Table 3.12: Logical Operators

Operator	Description
and	Returns the logical conjunction of the two expressions
or	Returns the logical disjunction of the two expressions
not	Returns the logical negation of the expression
implies	Returns the logical implication of the two expressions. Implication is calculated according to the truth table 3.13
xor	returns true if only one of the involved expressions evaluates to true and false otherwise

Table 3.13: Implies Truth Table

Left	Right	Result
------	-------	--------



true	true	true
true	false	false
false	true	true
false	false	true

### 3.4.5 Enumerations

EOL provides the `#` operator for accessing enumeration literals. For example, the `VisibilityEnum#vk_public` expression returns the value of the literal `vk_public` of the `VisibilityEnum` enumeration. For EMF metamodels, `VisibilityEnum#vk_public.instance` can also be used.

## 3.5 Statements

### 3.5.1 Variable Declaration Statement

A variable declaration statement declares the name and (optionally) the type and initial value of a variable in an EOL program. If no type is explicitly declared, the variable is assumed to be of type `Any`. For variables of primitive type, declaration automatically creates an instance of the type with the default values presented in Table 3.14. For non-primitive types the user has to explicitly assign the value of the variable either by using the `new` keyword or by providing an initial value expression. If neither is done the value of the variable is undefined. Variables in EOL are strongly-typed. Therefore a variable can only be assigned values that conform to its type (or a sub-type of it).

Table 3.14: Default values of primitive types

Type	Default value
Integer	0
Boolean	false
String	""
Real	0.0

**Scope** The scope of variables in EOL is generally limited to the block of statements where they are defined, including any nested blocks. Nevertheless, as discussed in the sequel, there are cases in task-specific languages that build atop EOL where the scope of variables is expanded to other non-nested blocks as well. EOL also allows variable shadowing; that

```

1 var i : Integer = 5;
2 var c : new Uml!Class;
3 //i = "somevalue";
4 if (c.isDefined()) {
5     var i : String;
6     i = "somevalue";
7 }
8 i = 3;

```

Listing 3.14: Example illustrating declaration and use of variables

is to define a variable with the same name in a nested block that overrides a variable defined in an outer block.

In Listing 3.14, an example of declaring and using variables is provided. Line 1 defines a variable named *i* of type *Integer* and assigns it an initial value of 5. Line 2 defines a variable named *c* of type *Class* (from model *Uml*) and creates a new instance of the type in the model (by using the *new* keyword). The commented out assignment statement of line 3 would raise a runtime error since it would attempt to assign a *String* value to an *Integer* variable. The condition of line 4 returns true since the *c* variable has been initialized before. Line 5 defines a new variable also named *i* that is of type *String* and which overrides the *Integer* variable declared in line 1. Therefore the assignment statement of line 6 is legitimate as it assigns a string value to a variable of type *String*. Finally, as the program has exited the scope of the *if* statement, the assignment statement of line 7 is also legitimate as it refers to the *i* variable defined in line 1.

### 3.5.2 Assignment Statement

The assignment statement is used to update the values of variables and properties of native objects and model elements.

**Variable Assignment** When the left hand side of an assignment statement is a variable, the value of the variable is updated to the object to which the right hand side evaluates to. If the type of the right hand side is not compatible (kind-of relationship) with the type of the variable, the assignment is illegal and a runtime error is raised. Assignment to objects of primitive types is performed by value while assignment to instances of non-primitive values is performed by reference. For example, in Listing 3.15, in line 1 the value of the *a* variable is set to a new *Class* in the *Uml* model. In line 2, a new untyped variable *b* is declared and its value is assigned to *a*. In line 3 the name of the class is updated to *Customer* and thus, line 4 prints *Customer* to the standard output stream. On

the other hand, in Listing 3.16, in line 1 the a String variable is declared. In line 2 an untyped variable b is declared. In line 3, the value of a is changed to Customer (which is an instance of the primitive *String* type). This has no effect on b and thus line 4 prints an empty string to the standard output stream.

**Native Object Property Assignment** When the left hand side of the assignment is a property of a native object, deciding on the legality and providing the semantics of the assignment is delegated to the execution engine. For example, in a Java-based execution engine, given that x is a native object, the statement  $x.y = a$  may be interpreted as  $x.setY(a)$  or if x is an instance of a map  $x.put("y",a)$ . By contrast, in a C# implementation, it can be interpreted as  $x.y = a$  since the language natively supports properties in classes.

**Model Element Property Assignment** When the left hand side of the assignment is a property of a model element, the model that owns the particular model element (accessible using the *ModelRepository.getOwningModel()* operation) is responsible for implementing the semantics of the assignment using its associated *propertyGetter* as discussed in Section 2.5. For example, if x is a model element, the statement  $x.y = a$  may be interpreted using the Java code of Listing 3.17 if x belongs to an EMF-based model or using the Java code of Listing 3.18 if it belongs to an MDR-based model.

### 3.5.3 Special Assignment Statement

In task-specific languages, an assignment operator with task-specific semantics is often required. Therefore, EOL provides an additional assignment operator. In standalone EOL, the operator has the same semantics with the primary assignment operator discussed above, however task-specific languages can redefine its semantics to implement custom

```
1 var a : new Uml!Class;  
2 var b = a;  
3 a.name = "Customer";  
4 b.name.println();
```

Listing 3.15: Assigning the value of a variable by reference

```
1 var a : String;  
2 var b = a;  
3 a = "Customer";  
4 b.println();
```

Listing 3.16: Assigning the value of a variable by value

```

1 EStructuralFeature feature = x.eClass().getEStructuralFeature("y");
2 x.eSet(feature, a);

```

Listing 3.17: Java code that assigns the value of a property of a model element that belongs to an EMF-based model

```

1 StructuralFeature feature = findStructuralFeature(x.refClass(), "y");
2 x.refSetValue(feature, a);

```

Listing 3.18: Java code that assigns the value of a property of a model element that belongs to an MDR-based model

assignment behaviour. For example, consider the simple model-to-model transformation of Listing 3.19 where a simple object oriented model is transformed to a simple database model using an ETL (see Section 5) transformation.

```

1 rule Class2Table
2   transform c : OO!Class
3   to t : DB!Table {
4
5     t.name = c.name;
6   }
7
8 rule Attribute2Column
9   transform a : OO!Attribute
10  to c : DB!Column {
11
12    c.name = a.name;
13    //c.owningTable = a.owningClass;
14    c.owningTable ::= a.owningClass;
15  }

```

Listing 3.19: A simple model-to-model transformation demonstrating the special assignment statement

The Class2Table rule transforms a Class of the OO model into a Table in the DB model and sets the name of the table to be the same as the name of the class. Rule Attribute2Column transforms an Attribute from the OO model into a column in the DB model. Except for setting its name (line 12), it also needs to define that the column belongs to the table which corresponds to the class that defines the source attribute. The commented-out assignment statement of line 13 cannot be used for this purpose since it would illegally attempt to assign the owningTable feature of the column to a model element of an inappropriate type (OO!Class). However, the special assignment operator in the task-specific language implements the semantics discussed in Section 5.5.4, and thus in line 14 it assigns to the owningTable feature not the class that owns the attribute but its

corresponding table (calculated using the Class2Table rule) in the DB model.

### 3.5.4 If Statement

As in most programming languages, an if statement consists of a condition, a block of statements that is executed if the condition is satisfied and (optionally) a block of statements that is executed otherwise. As an example, in Listing 3.20, if variable `a` holds a value that is greater than 0 the statement of line 3 is executed, otherwise the statement of line 5 is executed.

```
1 if (a > 0) {  
2   "A is greater than 0".println();  
3 }  
4 else { "A is less equal than 0".println(); }
```

Listing 3.20: Example illustrating an if statement

### 3.5.5 Switch Statement

A switch statement consists of an expression and a set of cases, and can be used to implement multi-branching. Unlike Java/C, switch in EOL doesn't by default fall through to the next case after a successful one. Therefore, it is not necessary to add a *break* statement after each case. To enable falling through to all subsequent cases you can use the *continue* statement. Also, unlike Java/C, the switch expression can return anything (not only integers). As an example, when executed, the code in Listing 3.21 prints 2 while the code in Listing 3.22 prints 2,3,default.

```
1 var i = "2";  
2  
3 switch (i) {  
4   case "1" : "1".println();  
5   case "2" : "2".println();  
6   case "3" : "3".println();  
7   default : "default".println();  
8 }
```

Listing 3.21: Example illustrating a switch statement

### 3.5.6 While Statement

A while statement consists of a condition and a block of statements which are executed as long as the condition is satisfied. For example, in Listing 3.23 the body of the while

```

1 var i = "2";
2
3 switch (i) {
4   case "1" : "1".println();
5   case "2" : "2".println(); continue;
6   case "3" : "3".println();
7   default : "default".println();
8 }

```

Listing 3.22: Example illustrating falling through cases in a switch statement

statement is executed 5 times printing the numbers 0 to 4 to the output console. Inside the body of a *while* statement, the built-in read-only *loopCount* integer variable holds the number of times the innermost loop has been executed so far (including the current iteration). Right after entering the loop for the first time and before running the first statement in its body, *loopCount* is set to 1, and it is incremented after each following iteration.

```

1 var i : Integer = 0;
2 while (i < 5) {
3   // both lines print the same thing
4   i.println();
5   (loopCount - 1).println();
6   // increment the counter
7   i = i+1;
8 }

```

Listing 3.23: Example of a while statement

### 3.5.7 For Statement

In EOL, for statements are used to iterate the contents of collections. A for statement defines a typed iterator and an iterated collection as well as a block of statements that is executed for every item in the collection that has a kind-of relationship with the type defined by the iterator. As with the majority of programming languages, modifying a collection while iterating it raises a runtime error. To avoid this situation, users can use the `clone()` built-in operation of the `Collection` type discussed in [3.3.2](#).

```

1 var col : Sequence = Sequence("a", 1, 2, 2.5, "b");
2 for (r : Real in col) {
3   r.print();
4   if (hasMore){", ".print();}
5 }

```

Listing 3.24: Example of a for statement

Inside the body of a *for* statement, two built-in read-only variables are visible: the *loopCount* integer variable (explained in Section 3.5.6) and the *hasMore* boolean variable. *hasMore* is used to determine if there are more items in the collection for which the loop will be executed. For example, in Listing 3.24 the *col* heterogeneous Sequence is defined that contains two strings (a and b), two integers (1,2) and one real (2.5). The *for* loop of line 2 only iterates through the items of the collection that are of kind *Real* and therefore prints 1,2,2.5 to the standard output stream.

### 3.5.8 Break, BreakAll and Continue Statements

To exit from *for* and *while* loops on demand, EOL provides the *break* and *breakAll* statements. The *break* statement exits the innermost loop while the *breakAll* statement exits all outer loops as well. On the other hand, to skip a particular loop and proceed with the next one, EOL provides the *continue* statement. For example, the excerpt of Listing 3.25, prints 2,1 3,1 to the standard output stream.

```
1 for (i in Sequence{1..3}) {
2   if (i = 1) {continue;}
3   for (j in Sequence{1..4}) {
4     if (j = 2) {break;}
5     if (j = 3) {breakAll;}
6     (i + ", " + j).println();
7   }
8 }
```

Listing 3.25: Example of the *break*, *breakAll* and *continue* statements

### 3.5.9 Throw Statement

EOL provides the *throw* statement for throwing a value as an *EOLUSEREXCEPTION* Java exception. This is especially useful when invoking EOL scripts from Java code: by catching and processing the exception, the Java code may be able to automatically handle the problem without requiring user input. Any value can be thrown, as shown in Listing 3.26, where we throw a number and a string.

```
1 throw 42;
2 throw "Error!";
```

Listing 3.26: Example of the *throw* statement

### 3.5.10 Transaction Statement

As discussed in Section 2.6, the underlying EMC layer provides support for transactions in models. To utilize this feature EOL provides the transaction statement. A transaction statement (optionally) defines the models that participate in the transaction. If no models are defined, it is assumed that all the models that are accessible from the enclosing program participate. When the statement is executed, a transaction is started on each participating model. If no errors are raised during the execution of the contained statements, any changes made to model elements are committed. On the other hand, if an error is raised the transaction is rolled back and any changes made to the models in the context of the transaction are undone. The user can also use the abort statement to explicitly exit a transaction and roll-back any changes done in its context. In Listing 3.27, an example of using this feature in a simulation problem is illustrated.

```
1 var system : System.allInstances.first();
2
3 for (i in Sequence {1..100}) {
4
5     transaction {
6
7         var failedProcessors : Set;
8
9         while (failedProcessors.size() < 10) {
10            failedProcessors.add(system.processors.random());
11        }
12
13        for (processor in failedProcessors) {
14            processor.failed = true;
15            processor.moveTasksElsewhere();
16        }
17
18        system.evaluateAvailability();
19
20        abort;
21    }
22
23 }
```

Listing 3.27: Example of a transaction statement

In this problem, a system consists of a number of processors. A processor manages some tasks and can fail at any time. The EOL program in Listing 3.27 performs 100 simulation steps, in every one of which 10 random processors from the model (lines 7-11) are marked as failed by setting their *failed* property to true (line 14). Then, the tasks that the failed processors manage are moved to other processors (line 15). Finally the availability of the



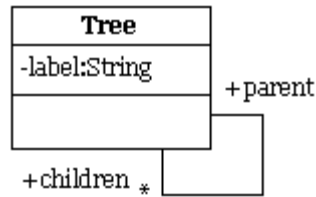

Figure 3.4: The Tree Metamodel

system in this state is evaluated.

After a simulation step, the state of the model has been drastically changed since processors have failed and tasks have been relocated. To be able to restore the model to its original state after every simulation step, each step is executed in the context of a transaction which is explicitly aborted (line 20) after evaluating the availability of the system. Therefore after each simulation step the model is restored to its original state for the next step to be executed.

### 3.6 Extended Properties

Quite often, during a model management operation it is necessary to associate model elements with information that is not supported by the metamodel they conform to. For instance, the EOL program in listing 3.28 calculates the depth of each Tree element in a model that conforms to the Tree metamodel displayed in Figure 3.4.

As the Tree metamodel doesn't support a *depth* property in the Tree metaclass, each Tree has to be associated with its calculated depth (line 12) using the *depths* map defined in line 1. Another approach would be to extend the Tree metamodel to support the desired *depth* property; however, applying this technique every time an additional property is needed for some model management operation would quickly pollute the metamodel with properties of secondary importance.

To simplify the code required in such cases, EOL provides the concept of *extended properties*. In terms of concrete syntax, an extended property is a normal property, the name of which starts with the tilde character (~). With regards to its execution semantics, the first time the value of an extended property of an object is assigned, the property is created and associated with the object. Then, the property can be accessed as a normal property. If an extended property is accessed before it is assigned, it returns *null*. Listing 3.29 demonstrates using a *depth* extended property to eliminate the need for using the *depths* map in Listing 3.28.

```

1  var depths = new Map;
2
3  for (n in Tree.allInstances.select(t|not t.parent.isDefined())) {
4      n.setDepth(0);
5  }
6
7  for (n in Tree.allInstances) {
8      (n.name + " " + depths.get(n)).println();
9  }
10
11 operation Tree setDepth(depth : Integer) {
12     depths.put(self, depth);
13     for (c in self.children) {
14         c.setDepth(depth + 1);
15     }
16 }

```

Listing 3.28: Calculating and printing the depth of each Tree

```

1  for (n in Tree.allInstances.select(t|not t.parent.isDefined())) {
2      n.setDepth(0);
3  }
4
5  for (n in Tree.allInstances) {
6      (n.name + " " + n.~depth).println();
7  }
8
9  operation Tree setDepth(depth : Integer) {
10     self.~depth = depth;
11     for (c in self.children) {
12         c.setDepth(depth + 1);
13     }
14 }

```

Listing 3.29: A simplified version of Listing 3.28 using extended properties

## 3.7 Context-Independent User Input

A common assumption in model management languages is that model management tasks are only executed in a batch-manner without human intervention. However, as demonstrated in the sequel, it is often useful for the user to provide feedback that can precisely drive the execution of a model management operation.

Model management operations can be executed in a number of runtime environments in each of which a different user-input method is more appropriate. For instance when executed in the context of an IDE (such as Eclipse) visual dialogs are preferable, while when executed in the context of a server or from within an ANT workflow, a command-line user input interface is deemed more suitable. To abstract away from the different

runtime environments and enable the user to specify user interaction statements uniformly and regardless of the runtime context, EOL provides the *IUserInput* interface that can be realized in different ways according to the execution environment and attached to the runtime context via the *IEolContext.setUserInput(IUserInput userInput)* method. The *IUserInput* specifies the methods presented in Table 3.15.

Table 3.15: Operations of IUserInput

Signature	Description
inform(message : String)	Displays the specified message to the user
confirm(message : String, [default : Boolean]) : Boolean	Prompts the user to confirm if the condition described by the message holds
prompt(message : String, [default : String]) : String	Prompts the user for a string in response to the message
promptInteger(message : String, [default : Integer]) : Integer	Prompts the user for an Integer
promptReal(message : String, [default : Real]) : Real	Prompts the user for a Real
choose(message : String, options : Sequence, [default : Any]) : Any	Prompts the user to select one of the options
chooseMany(message : String, options : Sequence, [default : Sequence]) : Sequence	Prompts the user to select one or more of the options

As displayed above, all the methods of the *IUserInput* interface accept a *default* parameter. The purpose of this parameter is dual. First, it enables the designer of the model management program to prompt the user with the most likely value as a default choice and secondly it enables a concrete implementation of the interface (*UnattendedExecutionUserInput*) which returns the default values without prompting the user at all and thus, can be used for unattended execution of interactive Epsilon programs. Figures 3.5 and 3.6 demonstrate the interfaces through which input is required by the user when the exemplar *System.user.promptInteger('Please enter a number', 1)*; statement is executed using an Eclipse-based and a command-line-based *IUserInput* implementation respectively.

User-input facilities have been found to be particularly useful in all model management tasks. Such facilities are essential for performing operations on live models such as

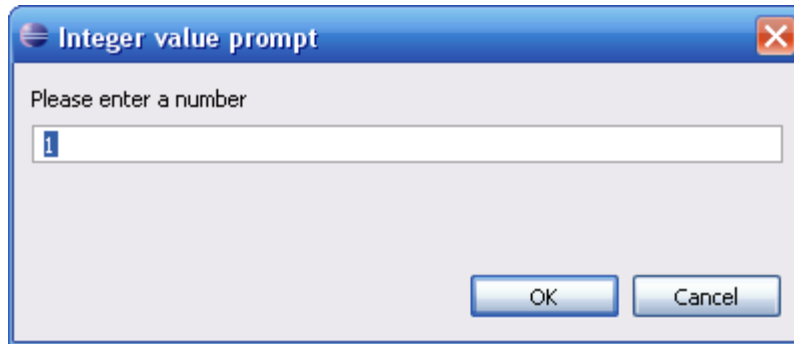

Figure 3.5: Example of an Eclipse-based IUserInput implementation

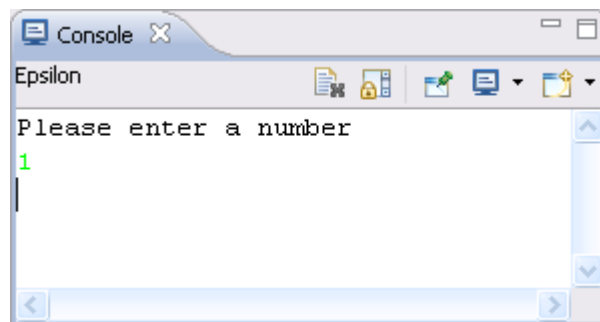

Figure 3.6: Example of a command-line-based IUserInput implementation

model validation and model refactoring but can also be useful in model comparison where marginal matching decisions can be delegated to the user and model transformation where the user can interactively specify the elements that will be transformed into corresponding elements in the target model. Examples of interactive model management operations that make use of the input facilities provided by EOL are demonstrated in Sections 5.6 and 8.5

## 3.8 Task-Specific Languages

Having discussed EOL in detail, in the following chapters, the following task-specific languages built atop EOL are presented:

- Epsilon Validation Language (EVL, [Chapter 4](#))
- Epsilon Transformation Language (ETL, [Chapter 5](#))
- Epsilon Generation Language (EGL, [Chapter 7](#))
- Epsilon Wizard Language (EWL, [Chapter 6](#))

- Epsilon Comparison Language (ECL, [Chapter 8](#))
- Epsilon Merging Language (EML, [Chapter 9](#))
- Flock Model Migration Language ([Chapter 10](#)) )
- Epsilon Pattern Language (EPL, [Chapter 11](#))
- Epsilon Model Generation (EMG, [Chapter 12](#))

For each language, the abstract and concrete syntax are presented. To enhance readability, the concrete syntax of each language is presented in an abstract, pseudo-grammar form. An informal but detailed discussion, accompanied by concise examples for each feature of interest, of its execution semantics and the runtime structures that are essential to implement those semantics is also provided.

Descriptions of the abstract and concrete syntaxes of the task-specific languages are particularly brief since they inherit most of their syntax and features from EOL. As discussed earlier, this contributes to establishing a platform of uniform languages where each provides a number of unique task-specific constructs but does not otherwise deviate from each other.

To reduce unnecessary repetition, the following sections do not repeat all the features inherited from EOL. However, the reader should bear in mind that by being supersets of EOL, all task-specific languages can exploit the features it provides. For example, by reusing EOL's user-input facilities (discussed in [3.7](#)), it is feasible to specify interactive model to model transformations in ETL. As well, *Native* types can be used to access or update information stored in an external system/tool (e.g. in a database or a remote server) during model validation with EVL or model comparison with ECL.

Following the presentation, in [Chapters 4 – 11](#), of the task-specific languages implemented in Epsilon, [Chapter 13](#) provides a brief overview of the process needed to construct a new language that addresses a task that is not supported by one of the existing languages.



# Chapter 4

## The Epsilon Validation Language (EVL)

The aim of EVL is to contribute model validation capabilities to Epsilon. More specifically, EVL can be used to specify and evaluate constraints on models of arbitrary metamodels and modelling technologies. This section provides a discussion on the motivation for implementing EVL, its abstract and concrete syntax as well as its execution semantics. It also provides two examples using the language to verify inter-model and intra-model consistency.

### 4.1 Motivation

Although many approaches have been proposed to enable automated model validation, the Object Constraint Language (OCL) [1] is the de facto standard for capturing constraints in modelling languages specified using object-oriented metamodeling technologies. While its powerful syntax enables users to specify meaningful and concise constraints, its purely declarative and side-effect free nature introduces a number of limitations in the context of a contemporary model management environment. In this section, the shortcomings of OCL that have motivated the design of EVL are discussed in detail.

In OCL, structural constraints are captured in the form of *invariants*. Each invariant is defined in the context of a meta-class of the metamodel and specifies a name and a body. The body is an OCL expression that must evaluate to a *Boolean* result, indicating whether an instance of the meta-class satisfies the invariant or not. Execution-wise, the body of each invariant is evaluated for each instance of the meta-class and the results are stored in a set of <Element, Invariant, Boolean> triplets. Each triplet captures the *Boolean* result of the evaluation of an *Invariant* on a qualified *Element*. An exemplar OCL invariant for UML 1.4, requiring that abstract operations only belong to abstract classes, is shown in Listing 4.1.

```
1 context Operation
2   inv AbstractOperationInAbstractClassOnly :
3     self.isAbstract implies self.owner.isAbstract
```

Listing 4.1: OCL constraint on UML operations

While OCL enables users to capture particularly complex invariants, it also demonstrates a number of shortcomings, as follows.

#### 4.1.1 Limited user feedback

OCL does not support specifying meaningful messages that can be reported to the user in case an invariant is not satisfied for certain elements. Therefore, feedback to the user is limited to the name of the invariant and the instance(s) for which it failed. Weak support for proper feedback messages implies that the end users must be familiar with OCL so that they can comprehend the meaning of the failed invariant and locate the exact reason for the failure. This is a significant shortcoming as in practice only a very small number of end users are familiar with OCL.

#### 4.1.2 No support for warnings/critiques

Contemporary software development environments typically produce two types of feedback when checking artefacts for consistency and correctness: errors and warnings. Errors indicate critical deficiencies that contradict basic principles and invalidate the developed artefacts. By contrast, warnings (or critiques) indicate non-critical issues that should nevertheless be addressed by the user. To enable users to address warnings in a priority-based manner, they are typically categorized into three levels of importance: High, Medium and Low (although other classifications are also possible).

Nevertheless, in OCL there is no such distinction between errors and warnings and consequently all reported issues are considered to be errors. This adds an additional burden to identifying and prioritizing issues of major importance, particularly within an extensive set of unsatisfied invariants in complex models.

#### 4.1.3 No support for dependent constraints

Each OCL invariant is a self-contained unit that does not depend on other invariants. There are cases where this design decision is particularly restrictive. For instance consider the invariants *I1* and *I2* displayed in Listing 4.2. Both *I1* and *I2* are applicable on UML classes with *I1* requiring that: *the name of a class must not be empty* and *I2* requiring that: *the*



name of a class must start with a capital letter. In the case of those two invariants, if *I1* is not satisfied for a particular UML class, evaluating *I2* on that class would be meaningless. In fact it would be worse than meaningless since it would consume time to evaluate and would also produce an extraneous error message to the user. In practice, to avoid the extraneous message, *I2* needs to replicate the body of *I1* using an *if* expression (lines 2 and 5).

```

1 context Class
2   inv I1 : self.name.size() > 0
3
4   inv I2 :
5     if self.name.size > 0 then
6       self.name.substring(0,1) =
7       self.name.substring(0,1).toUpper()
8     else
9       true
10    endif

```

Listing 4.2: Conceptually related OCL constraints

#### 4.1.4 Limited flexibility in context definition

As already discussed, in OCL invariants are defined in the context of meta-classes. While this achieves a reasonable partitioning of the model element space, there are cases where more fine-grained partitioning is required. For instance, consider the following scenario. Let  $IA_{1..N}$ ,  $IB_{1..M}$  be invariants applying to classes that are stereotyped as  $\langle\langle A \rangle\rangle$  and  $\langle\langle B \rangle\rangle$  respectively. Since OCL only supports partitioning the model element space using meta-classes, all  $IA_{1..N}$ ,  $IB_{1..M}$  must appear under the same context (i.e. *Class*). Moreover, each invariant must explicitly define that it addresses the one or the other conceptual sub-partition. Therefore, each of  $IA_{1..N}$  must limit its scope initially (using the *self.isA* expression) and then express the real body. In our example the simplest way to achieve this would be by combining a scope-limiting expression with the real invariant body using the *implies* clause as demonstrated in Listing 4.3.

Furthermore, if the *real* body of the invariant needs to assume that self is stereotyped with  $\langle\langle A \rangle\rangle$ , this technique is not applicable because OCL does not support lazy evaluation of Boolean clauses [1] and therefore although the first part of the expression (*self.isA*) may fail for some instances, the second part will still be evaluated thus producing runtime errors. In this case, an *if* expression must be used, further complicating the specified invariants.

```

1 context Class
2   inv I1 : self.isA implies <real-invariant-body>
3   inv I2 : self.isA implies <real-invariant-body>
4   ...
5   inv IN : self.isA implies <real-invariant-body>
6
7   def isA :
8     let isA : Boolean =
9       self.stereotype->exists(s|s.name = 'A')

```

Listing 4.3: Demonstration of OCL constraints with duplication

### 4.1.5 No support for repairing inconsistencies

While OCL can be used for detecting inconsistencies, it provides no means for repairing them. The reason is that OCL has been designed as a side-effect free language and therefore lacks constructs for modifying models. Nevertheless, there are many cases where inconsistencies are trivial to resolve and users can benefit from semi-automatic repairing facilities.

This need has been long recognized in the related field of code development tools (e.g. Eclipse, Microsoft Visual Studio, NetBeans). In such tools, errors are not only identified but also context-aware actions are proposed to the user for automatically repairing them. This feature significantly increases the usability of such tools and consequently enhances users' productivity.

### 4.1.6 No support for inter-model constraints

OCL expressions (and therefore OCL constraints) can only be evaluated in the context of a single model at a time. Consequently, OCL cannot be used to express constraints that span across different models. In the context of a large-scale model driven engineering process that involves many different models (that potentially conform to different modelling languages) this limitation is particularly severe.

Following this discussion on the shortcomings of OCL for capturing structural constraints in modelling languages, the following sections present the abstract and concrete syntax of EVL as well as their execution semantics, and explain how they address the aforementioned limitations.

## 4.2 Abstract Syntax

In EVL, validation specifications are organized in modules (*EvlModule*). As illustrated in Figure 4.1, *EvlModule* extends *EolLibraryModule* which means that it can contain user-defined operations and import other EOL library modules and EVL modules. Apart from operations, an EVL module also contains a set of invariants grouped by the context they apply to, and a number of *pre* and *post* blocks.

**Context** A context specifies the kind of instances on which the contained invariants will be evaluated. Each context can optionally define a guard which limits its applicability to a narrower subset of instances of its specified type. Thus, if the guard fails for a specific instance of the type, none of its contained invariants are evaluated.

**Invariant** As with OCL, each EVL invariant defines a *name* and a body (*check*). However, it can optionally also define a *guard* (defined in its abstract *GuardedElement* supertype) which further limits its applicability to a subset of the instances of the type defined by the embracing *context*. To achieve the requirement for detailed user feedback (Section 4.1.1), each invariant can optionally define a *message* as an *ExpressionOrStatementBlock* that should return a String providing a description of the reason(s) for which the constraint has failed on a particular element. To support semi-automatically fixing of elements on which invariants have failed (Section 4.1.5), an invariant can optionally define a number of *fixes*. Finally, as displayed in Figure 4.1, *Invariant* is an abstract class that is used as a super-class for the specific types *Constraint* and *Critique*. This is to address the issue of separation of errors and warnings/critiques (Section 4.1.2).

**Guard** Guards are used to limit the applicability of invariants (Section 4.1.4). This can be achieved at two levels. At the *Context* level it limits the applicability of all invariants of the context and at the *Invariant* level it limits the applicability of a specific invariant.

**Fix** A fix defines a title using an *ExpressionOrStatementBlock* instead of a static String to allow users to specify context-aware titles (e.g. *Rename class customer to Customer* instead of a generic *Convert first letter to upper-case*). Moreover, the *do* part is a statement block where the fixing functionality can be defined using EOL. The developer is responsible for ensuring that the actions contained in the *fix* actually repair the identified inconsistency.

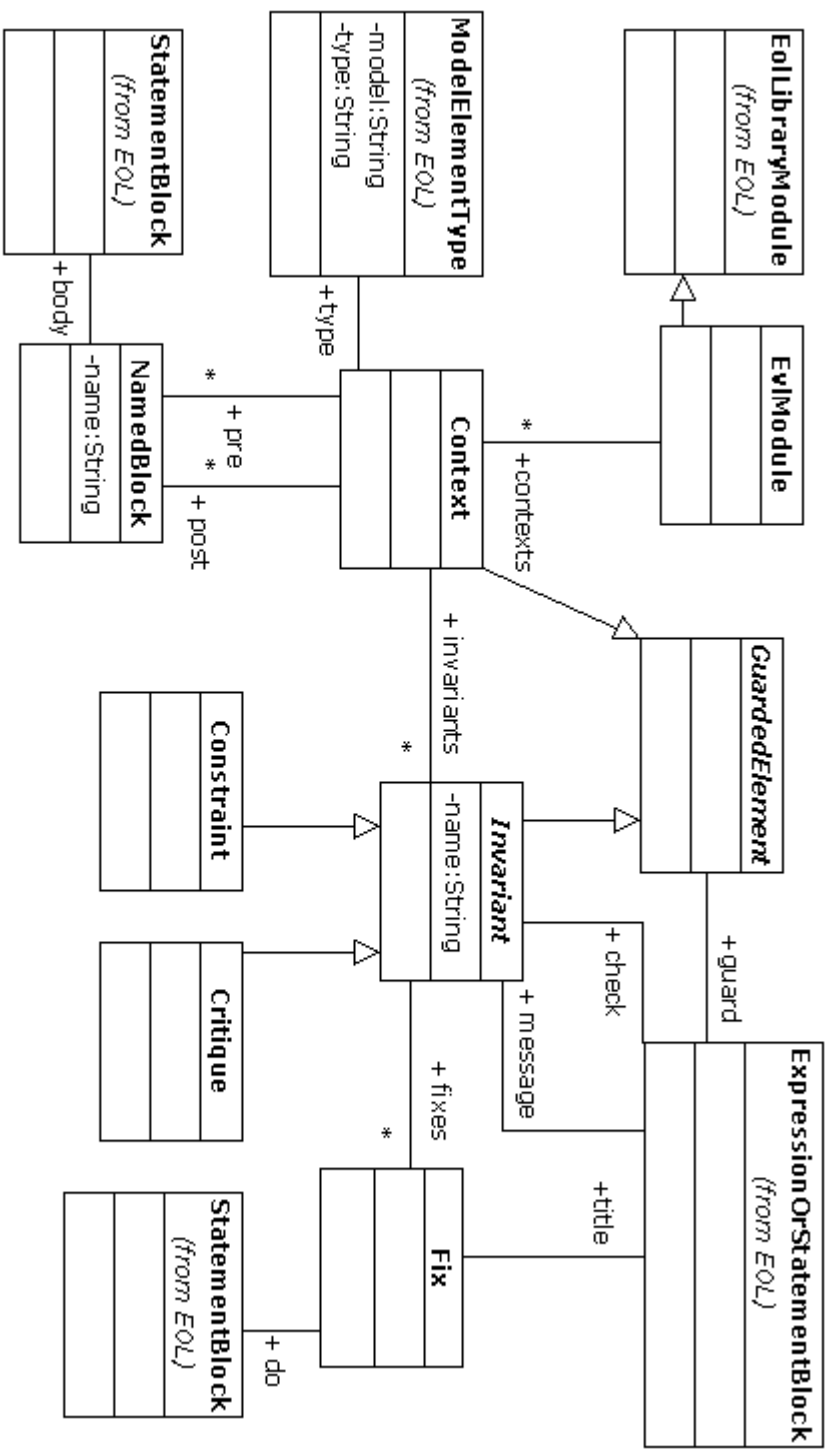

Figure 4.1: Abstract Syntax of EVL

**Constraint** *Constraints* in EVL are used to capture critical errors that invalidate the model. As discussed above, *Constraint* is a sub-class of *Invariant* and therefore inherits all its features.

**Critique** Unlike *Constraints*, *Critiques* are used to capture non-critical situations that do not invalidate the model, but should nevertheless be addressed by the user to enhance the quality of the model. This separation addresses the issue raised in Section 4.1.2.

**Pre and Post** An EVL module can define a number of named *pre* and a *post* blocks that contain EOL statements which are executed before and after evaluating the invariants respectively. These should not be confused with the pre-/post-condition annotations available for EOL user-defined operations (Section 3.2.2).

## 4.3 Concrete Syntax

Listings 4.4, 4.5 and 4.6 demonstrate the concrete syntax of the *context*, *invariant* and *fix* abstract syntax constructs discussed above.

```
1 (@lazy)?
2 context <name> {
3
4   (guard (:expression) | ({statementBlock}))?
5
6   (invariant)*
7 }
```

Listing 4.4: Concrete Syntax of an EVL context

```
1 (@lazy)?
2 (constraint | critique) <name> {
3
4   (guard (:expression) | ({statementBlock}))?
5
6   (check (:expression) | ({statementBlock}))?
7
8   (message (:expression) | ({statementBlock}))?
9
10  (fix)*
11 }
```

Listing 4.5: Concrete Syntax of an EVL invariant

```

1 fix {
2   (guard (:expression) | ({statementBlock}))?
3
4   (title (:expression) | ({statementBlock}))
5
6   do {
7     statementBlock
8   }
9 }

```

Listing 4.6: Concrete Syntax of an EVL fix

```

1 (pre | post) <name> {
2   statement+
3 }

```

Listing 4.7: Concrete Syntax of Pre and Post blocks

*Pre* and *post* blocks have a simple syntax that, as presented in Listing 4.7, consists of the identifier (*pre* or *post*), an optional name and the set of statements to be executed enclosed in curly braces.

## 4.4 Execution Semantics

Having discussed the abstract and concrete syntaxes of EVL, this section provides an informal discussion of the execution semantics of the language. The execution of an EVL module is separated into four phases:

**Phase 1** Before any invariant is evaluated, the *pre* sections of the module are executed in the order in which they have been specified.

**Phase 2** For each non-lazy *context* with at least one non-lazy invariant, the instances of the meta-class it defines are collected. For each instance, the *guard* of the *context* is evaluated. If the *guard* is satisfied, then for each non-lazy invariant contained in the context the invariant's *guard* is also evaluated. If the *guard* of the invariant is satisfied, the *body* of the invariant is evaluated. In case the *body* evaluates to *false*, the *message* part of the rule is evaluated and the produced message is added along with the instance, the invariant and the available *fixes* to the *ValidationTrace*.

The execution order of an EVL module follows a top-down depth-first scheme that respects the order in which the *contexts* and *invariants* appear in the module. However,

the execution order can change in case one of the *satisfies*, *satisfiesOne*, *satisfiesAll* built-in operations, discussed in detail in the sequel, are called.

**Phase 3** In this phase, the validation trace is examined for unsatisfied constraints and the user is presented with the message each one has produced. The user can then select one or more of the available *fixes* to be executed. Execution of *fixes* is performed in a transactional manner using the respective facilities provided by the model connectivity framework, as discussed in Section 2.6. This is to prevent runtime errors raised during the execution of a *fix* from compromising the validated model by leaving it in an inconsistent state.

**Phase 4** When the user has performed all the necessary *fixes* or chooses to end Phase 3 explicitly, the *post* section of the module is executed. There, the user can perform tasks such as serializing the validation trace or producing a summary of the validation process results.

#### 4.4.1 Capturing Dependencies Between Invariants

As discussed in Section 4.1.3, it is often the case that invariants conceptually depend on each other. To allow users capture such dependencies, EVL provides the *satisfies(invariant : String) : Boolean*, *satisfiesAll(invariants : Sequence(String)) : Boolean* and *satisfiesOne(invariants : Sequence(String)) : Boolean* built-in operations. Using these operations, an invariant can specify in its *guard* other invariants which need to be satisfied for it to be meaningful to evaluate.

When one of these operations is invoked, if the required *invariants* (either lazy or non-lazy) have been evaluated for the instances on which the operation is invoked, the engine will return their cached results; otherwise it will evaluate them and return their results.

### 4.5 Intra-Model Consistency Checking Example

This section presents a case study comparing EVL and OCL in the context of a common scenario. The purpose of the case study is to present readers with the concrete syntax of the language and demonstrate the benefits delivered by the additional constructs it facilitates.

## 4.5.1 Scenario: The Singleton Pattern

The *singleton* pattern is a widely used object oriented pattern. A *singleton* is a class for which *exactly one instance is allowed* [2]. In UML, a singleton is typically represented as a class which is stereotyped with a <<singleton>> stereotype and which also defines a static operation named *getInstance()* that returns the unique instance.

To ensure that all singletons have been modelled correctly in a UML model one needs to evaluate the following invariants on all classes that are stereotyped with the <<singleton>> stereotype:

- *DefinesGetInstance* : Each stereotyped class must define a *getInstance()* method
- *GetInstanceIsStatic* : The *getInstance()* method must be static
- *GetInstanceReturnsSame* : The return type of the *getInstance()* method must be the class itself

Obviously, invariants *GetInstanceIsStatic* and *GetInstanceReturnsSame* depend on *DefinesGetInstance* because if the singleton does not define a *getInstance()* operation, checking for the operation's scope and return type is meaningless. Moreover, in case an invariant fails, there are corrective actions (fixes) that users may want to perform semi-automatically: e.g. for *DefinesGetInstance*, such an action would be to add the missing *getInstance()* operation, for *GetInstanceIsStatic* to change it to static and for *GetInstanceReturnsSame* to set the return type to the class itself. In the following sections OCL and EVL are used to express the three constraints and then the two solutions are compared.

## 4.5.2 Using OCL to Express the Invariants

Listing 4.8 shows the aforementioned invariants implemented in OCL.

```
1 package Foundation::Core
2
3 context Class
4
5 def isSingleton :
6     let isSingleton : Boolean =
7         self.stereotype->exists(s|s.name = 'singleton')
8
9 def getInstanceOperation :
10    let getInstanceOperation : Operation =
11        self.feature->select(f|f.oclIsTypeOf(Operation))
```



```

12     and f.name = 'getInstance')->first().oclAsType(Operation)
13
14     inv DefinesGetInstanceOperation :
15         if isSingleton
16             then getInstanceOperation.isDefined
17             else true
18         endif
19
20     inv GetInstanceOperationIsStatic :
21         if isSingleton then
22             if getInstanceOperation.isDefined
23                 then getInstanceOperation.ownerScope = #classifier
24                 else false
25             endif
26         else
27             true
28         endif
29
30     inv GetOperationReturnsSame :
31         if isSingleton then
32             if getInstanceOperation.isDefined then
33                 if getInstanceOperation.returnParameter.isDefined
34                     then getInstanceOperation.returnParameter.type = self
35                     else false
36                 endif
37             else
38                 false
39             endif
40         else
41             true
42         endif
43
44     context Operation
45
46     def returnParameter :
47         let returnParameter : Parameter =
48             self.parameter->select(p|p.kind = #return)->first()
49
50 endpackage

```

Listing 4.8: OCL Module for Validating Singletons

By examining the OCL solution it can be observed that all invariants first check that the class is a singleton (lines 15, 21 and 31) by using the *isSingleton* derived property

defined in line 5. If the `isSingleton` returns *false*, the invariants return *true* since returning *false* would cause them to fail for all non-singleton classes. This reveals an additional shortcoming of OCL: if a constraint returns *true* it may mean two different things: either that the instance satisfies the constraint or that the constraint is not applicable to the instance at all. In our view, this overloading reduces understandability.

By further studying the solution of Listing 4.8 it can be noticed that dependency between constraints is captured artificially using nested *if* expressions. For instance, both `GetInstanceIsStatic` and `GetInstanceReturnsSame` contain an *if* expression in lines 22 and 32 respectively, requiring that they recalculate the value of the `getInstanceOperation` defined in line 9, where they actually recalculate the result of the `DefinesGetInstanceOperation` invariant. As discussed in Section 4.1.3, this happens because OCL lacks constructs for capturing dependencies in a structured manner.

### 4.5.3 Using EVL to Express the Invariants

Listing 4.9 provides a solution for this problem expressed in EVL.

```
1 context Singleton {
2
3   guard : self.stereotype->exists(s|s.name = "singleton")
4
5   constraint DefinesGetInstance {
6     check : self.getGetInstanceOperation().isDefined()
7     message : "Singleton " + self.name +
8       " must define a getInstance() operation"
9     fix {
10      title : "Add a getInstance() operation to " + self.name
11      do {
12        // Create the getInstance operation
13        var op : new Operation;
14        op.name = "getInstance";
15        op.owner = self;
16        op.ownerScope = ScopeKind#sk_classifier;
17
18        // Create the return parameter
19        var returnParameter : new Parameter;
20        returnParameter.type = self;
21        op.parameter = Sequence{returnParameter};
22        returnParameter.kind = ParameterDirectionKind#pdk_return;
```

```

23     }
24   }
25 }
26
27 constraint GetInstanceIsStatic {
28   guard : self . satisfies ("DefinesGetInstance")
29   check : self .getGetInstanceOperation().ownerScope =
30     ScopeKind#sk_classifier
31   message : " The getInstance() operation of singleton "
32     + self.name + " must be static"
33
34   fix {
35     title : "Change to static"
36     do {
37       self .getGetInstanceOperation.ownerScope
38         = ScopeKind#sk_classifier;
39     }
40   }
41 }
42
43 constraint GetInstanceReturnsSame {
44
45   guard : self . satisfies ("DefinesGetInstance")
46   check {
47     var returnParameter : Parameter;
48     returnParameter = self.getReturnParameter();
49     return (returnParameter->isDefined()
50       and returnParameter.type = self);
51   }
52   message : " The getInstance() operation of singleton "
53     + self.name + " must return " + self.name
54
55   fix {
56     title : "Change return type to " + self.name
57     do {
58       var returnParameter : Parameter;
59       returnParameter = self.getReturnParameter();
60

```

```

61     // If the operation does not have a return parameter
62     // create one
63     if (not returnParameter.isDefined()){
64         returnParameter = Parameter.newInstance();
65         returnParameter.kind = ParameterDirectionKind#pdk_return;
66         returnParameter.behavioralFeature =
67             self.getInstanceOperation();
68     }
69     // Set the correct return type
70     returnParameter.type = self;
71 }
72 }
73 }
74 }
75
76 operation Class getGetInstanceOperation() : Operation {
77     return self.feature.
78     select (o:Operation | o.name = "getInstance").first();
79 }
80
81 operation Operation getReturnParameter() : Parameter {
82     return self.parameter.
83     select (p:Parameter | p.kind =
84         ParameterDirectionKind#pdk_return).first();
85 }

```

Listing 4.9: EVL Module for Validating Singletons

The *Singleton* context defines that the invariants it contains will be evaluated on instances of the UML *Class* type. Moreover, its guard defines that they will be evaluated only on classes that are stereotyped with the *singleton* stereotype. Therefore, unlike the OCL solution of Listing 4.8, invariants contained in this context do not need to check individually that the instances on which they are evaluated are singletons.

Constraint *DefinesGetInstance* defines no guard which means that it will be evaluated for all the instances of the context. In its *check* part, the constraint examines if the class defines an operation named *getInstance()* by invoking the *getGetInstanceOperation()* operation. If this fails, it proposes a fix that adds the missing operation to the class.

Constraint *GetInstanceIsStatic* defines a guard which states that for the constraint to be evaluated on an instance, the instance must first satisfy the *DefinesGetInstance* constraint.

If it doesn't, it is not evaluated at all. In its *check* part it examines that the *getInstance()* operation is static. Note that here the constraint needs not check that the *getInstance()* operation is defined again since this is assumed by the *DefinesGetInstance* constraint on which it depends. If the constraint fails for an instance, the *fix* part can be invoked to change the scope of the *getInstance()* operation to static.

Constraint *GetInstanceReturnsSame* checks that the return type of the *getInstance()* operation is the singleton itself. Similarly to the *GetInstanceIsStatic* constraint, it defines that to be evaluated the *DefinesGetInstance* constraint must be satisfied. If it fails for a particular instance, the *fix* part can be invoked. In the *fix* part, if the operation defines a return parameter of incorrect type, its type is changed and if it does not define a return parameter at all, the parameter is created and added to the parameters of the operation.

By observing the two solutions the OCL solution resembles the concept of defensive programming, where conditions are embedded in supplier code, while the EVL one is closer to the design by contract [3] approach where conditions are explicitly checked in guards.

This case study has demonstrated that the additional constructs provided by EVL can reduce repetition significantly and thus enable specification of more concise constraints. Moreover, in case a constraint is not satisfied for a particular instance, the user is provided with a meaningful context-aware message and with automated facilities (fixes) for repairing the inconsistency.

## 4.6 Inter-Model Consistency Checking Example

In the previous example, EVL was used to check the internal consistency of a single UML model. By contrast, this example demonstrates using EVL to detect and repair occurrences of incompleteness and contradiction between two different models. In this exam-

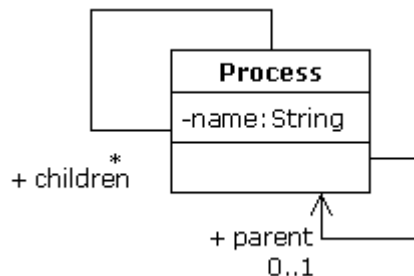

Figure 4.2: The ProcessLang Metamodel

ple the simplified *ProcessLang* metamodel, which captures information about hierarchical processes, is used. To add performance information in a separate aspect *ProcessPerformanceLang* metamodel is also defined. The metamodels are displayed in Figures 4.2 and 4.3 respectively.

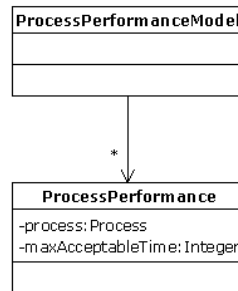

Figure 4.3: The ProcessPerformanceLang Metamodel

There are two constraints that need to be defined and evaluated in this example: that each *Process* in a process model (*PM*) has a corresponding *ProcessPerformance* in the process performance model (*PPM*), and that the *maxAcceptableTime* of a process does not exceed the sum of the *maxAcceptableTimes* of its children. This is achieved with the *PerformanceIsDefined* and the *PerformanceIsValid* EVL constraints displayed in Listing 4.10.

```

1 context PM!Process {
2   constraint PerformanceIsDefined {
3
4     check {
5       var processPerformances =
6         PPM!ProcessPerformance.
7         allInstances.select(pt|pt.process = self);
8
9       return processPerformances.size() = 1;
10    }
11
12   message {
13     var prefix : String;
14     if (processPerformances.size() = 1) {
15       prefix = "More than one performance info";
16     }
17     else {
18       prefix = "No performance info";
19     }
20     return prefix + " found for process "
21     + self.name;
  
```

```

22     }
23
24     fix {
25         title : "Set the performance of " + self.name
26
27         do {
28             for (p in processPerformances.clone()) {
29                 delete p;
30             }
31             var maxAcceptableTime : Integer;
32             maxAcceptableTime = UserInput.
33                 promptInteger("maxAcceptableTime", 0);
34             var p :
35                 new PPM!ProcessPerformance;
36             p.maxAcceptableTime = maxAcceptableTime;
37             p.process = self;
38         }
39     }
40 }
41
42 constraint PerformanceIsValid {
43
44     guard : self.satisfies("PerformanceIsDefined")
45     and self.children.forAll
46         (c|c.satisfies("PerformanceIsDefined"))
47
48     check {
49         var sum : Integer;
50         sum = self.children.
51             collect (c|c.getMaxAcceptableTime())
52             .sum().asInteger();
53         return self.getMaxAcceptableTime() >= sum;
54     }
55
56     message : "Process " + self.name +
57         " has a smaller maxAcceptableTime "
58         + "than the sum of its children"
59
60     fix {
61         title : "Increase maxAcceptableTime to " + sum
62         do {
63             self.setMaxAcceptableTime(sum);
64         }

```

```

65     }
66
67 }
68
69 }
70
71 operation PM!Process getMaxAcceptableTime ()
72 : Integer {
73     return PPM!ProcessPerformance.
74     allInstances.selectOne (pt |pt.process=self)
75     .maxAcceptableTime;
76 }
77
78 operation PM!Process setMaxAcceptableTime
79 (time : Integer) {
80     PPM!ProcessPerformance.allInstances.
81     selectOne (pt |pt.process=self) .maxAcceptableTime =
82     time;
83 }

```

Listing 4.10: Exemplar EVL module containing a cross-model constraint

In line 4, the check part of the *PerformanceIsDefined* constraint calculates the instances of *ProcessPerformance* in the *ProcessPerformanceModel* that have their *process* reference set to the currently examined *Process* (accessible via the *self* built-in variable) and stores it in the *processPerformances* variable. If exactly one *ProcessPerformance* is defined for the *Process*, the constraint is satisfied. Otherwise, the *message* part of the constraint, in line 12, is evaluated and an appropriate error message is displayed to the user.

Note that the *processPerformances* variable defined in the *check* part is also used from within the *message* part of the constraint. As discussed in [4], EVL provides this feature to reduce the need for duplicate calculations as our experience has shown that the message for a failed constraint often needs to utilize side-information collected in the *check* part.

To repair the inconsistency, the user can invoke the *fix* defined in line 24 that will delete any existing *ProcessPerformance* instances and create a new one with a user-defined *maxAcceptableTime* obtained using the *UserInput.promptInteger()* statement of line 32.

Unlike the *PerformanceIsDefined* constraint, the *PerformanceIsValid* constraint, line 42, defines a *guard* part (line 44). As discussed in [4], the guard part of a constraint is used to further limit the applicability of the constraint beyond the simple type check performed in the containing *context*. In this rule, the validity of the *maxAcceptableTime* of a *Process* needs to be checked only if one has been defined in the *ProcessPerformanceModel*. Therefore, the



guard part of the constraint specifies that this constraint is only applicable to *Processes* where, both they and they children, satisfy the *PerformanceIsDefined* constraint.

The check part of the constraint retrieves the *maxAcceptableTime* of the process and that of its children and compares them. As the *Process* itself does not define performance information, retrieval of the value of the *maxAcceptableTime* of the respective *ProcessPerformance* object is implemented using the user-defined *getMaxAcceptableTime()* operation that is defined in line 71. In case the constraint is not satisfied, the user can invoke the *fix* defined in line 60 to repair the inconsistency by setting the *maxAcceptableTime* of the process to the *sum* calculated in line 50. As discussed earlier, the *fix* parts of EVL invariants do not in any way guarantee that they do fix the problem they target or that in their effort to fix one problem they do not create another problem; this is left to the user. For instance, in this particular example, changing the *maxAcceptableTime* of a process through a *fix* block may render its parent process invalid.

To demonstrate the evaluation of these constraints two exemplar models that conform to the *ProcessLang* and *ProcessPerformanceLang* metamodels are used. A visual representation of the models is displayed in Figure 4.4.

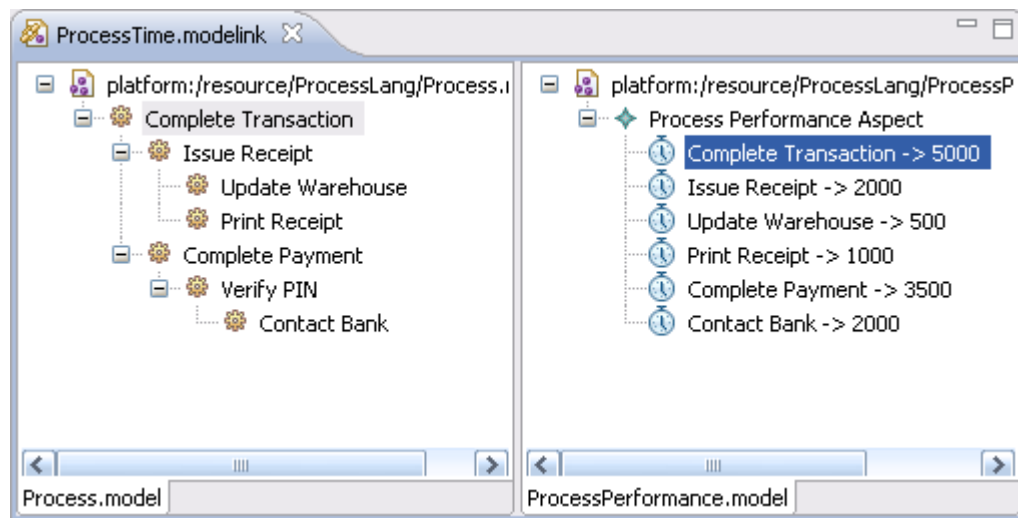

Figure 4.4: Exemplar Process and ProcessPerformance models

Evaluating the constraints in the context of those two models reveals two problems which are reported to the user via the view displayed in Figure 4.5. Indeed by examining the two models of Figure 4.4, it becomes apparent that there is no *ProcessPerformance* linked to the *Verify PIN* process and also that the *maxAcceptableTime* of *Complete Transaction* (5000) is less than the sum of the *maxAcceptableTimes* of its children (2000 + 3500).

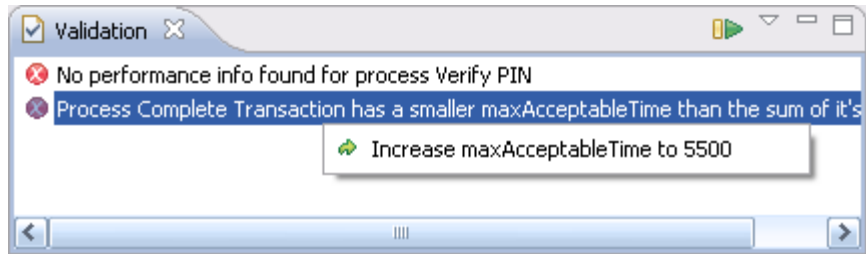

Figure 4.5: Screenshot of the validation view reporting the identified inconsistencies

## 4.7 Summary

This section has provided a detailed discussion on the EVL model-validation language which conceptually (as opposed to technically) extends OCL. EVL provides a number of features such as support for detailed user feedback, constraint dependency management, semi-automatic transactional inconsistency resolution and (as it is based on EOL) access to multiple models of diverse metamodels and technologies.

# Chapter 5

## The Epsilon Transformation Language (ETL)

The aim of ETL [5] is to contribute model-to-model transformation capabilities to Epsilon. More specifically, ETL can be used to transform an arbitrary number of input models into an arbitrary number of output models of different modelling languages and technologies at a high level of abstraction.

### 5.1 Style

Three styles are generally recognized in model transformation languages: declarative, imperative and hybrid, each one demonstrating particular advantages and shortcomings. Declarative transformation languages are generally limited to scenarios where the source and target metamodels are similar to each other in terms of structure and thus, the transformation is a matter of a simple mapping. However they fail to address cases where significant processing and complex mappings are involved. On the other hand, purely imperative transformation languages are capable of addressing a wider range of transformation scenarios. Nevertheless, they operate at a low level of abstraction which means that users need to manually address issues such as tracing and resolving target elements from their source counterparts and orchestrating the transformation execution. To address those shortcomings, hybrid languages (such as ATL [6] and QVT [7]) provide both a declarative rule-based execution scheme as well as imperative features for handling complex transformation scenarios.

Under this rationale, ETL has been designed as a hybrid language that implements a task-specific rule definition and execution scheme but also inherits the imperative features of EOL to handle complex transformations where this is deemed necessary.

## 5.2 Source and Target Models

The majority of model-to-model transformation languages assume that only two models participate in each transformation: the source model and the target model. Nevertheless, it is often essential to be able to access/update additional models during a transformation (such as trace or configuration models). Building on the facilities provided by EMC and EOL, ETL enables specification of transformations that can transform an arbitrary number of source models into an arbitrary number of target models.

Another common assumption is that the contents of the target models are insignificant and thus a transformation can safely overwrite their contents. As discussed in the sequel, ETL - like all Epsilon languages - enables the user to specify, for each involved model, whether its contents need to be preserved or not.

## 5.3 Abstract Syntax

As illustrated in Figure 5.1, ETL transformations are organized in modules (*EtlModule*). A module can contain a number of transformation rules (*TransformationRule*). Each rule has a unique name (in the context of the module) and also specifies one *source* and many *target* parameters. A transformation rule can also *extend* a number of other transformation rules and be declared as *abstract*, *primary* and/or *lazy*<sup>1</sup>. To limit its applicability to a subset of elements that conform to the type of the *source* parameter, a rule can optionally define a guard which is either an EOL expression or a block of EOL statements. Finally, each rule defines a block of EOL statements (*body*) where the logic for populating the property values of the target model elements is specified.

Besides transformation rules, an ETL module can also optionally contain a number of *pre* and *post* named blocks of EOL statements which, as discussed later, are executed before and after the transformation rules respectively. These should not be confused with the pre-/post-condition annotations available for EOL user-defined operations (Section 3.2.2).

## 5.4 Concrete Syntax

The concrete syntax of a transformation rule is displayed in Listing 5.1. The optional *abstract*, *lazy* and *primary* attributes of the rule are specified using respective annotations. The name of the rule follows the *rule* keyword and the *source* and *target* parameters are

---

<sup>1</sup>The concept of lazy rules was first introduced in ATL

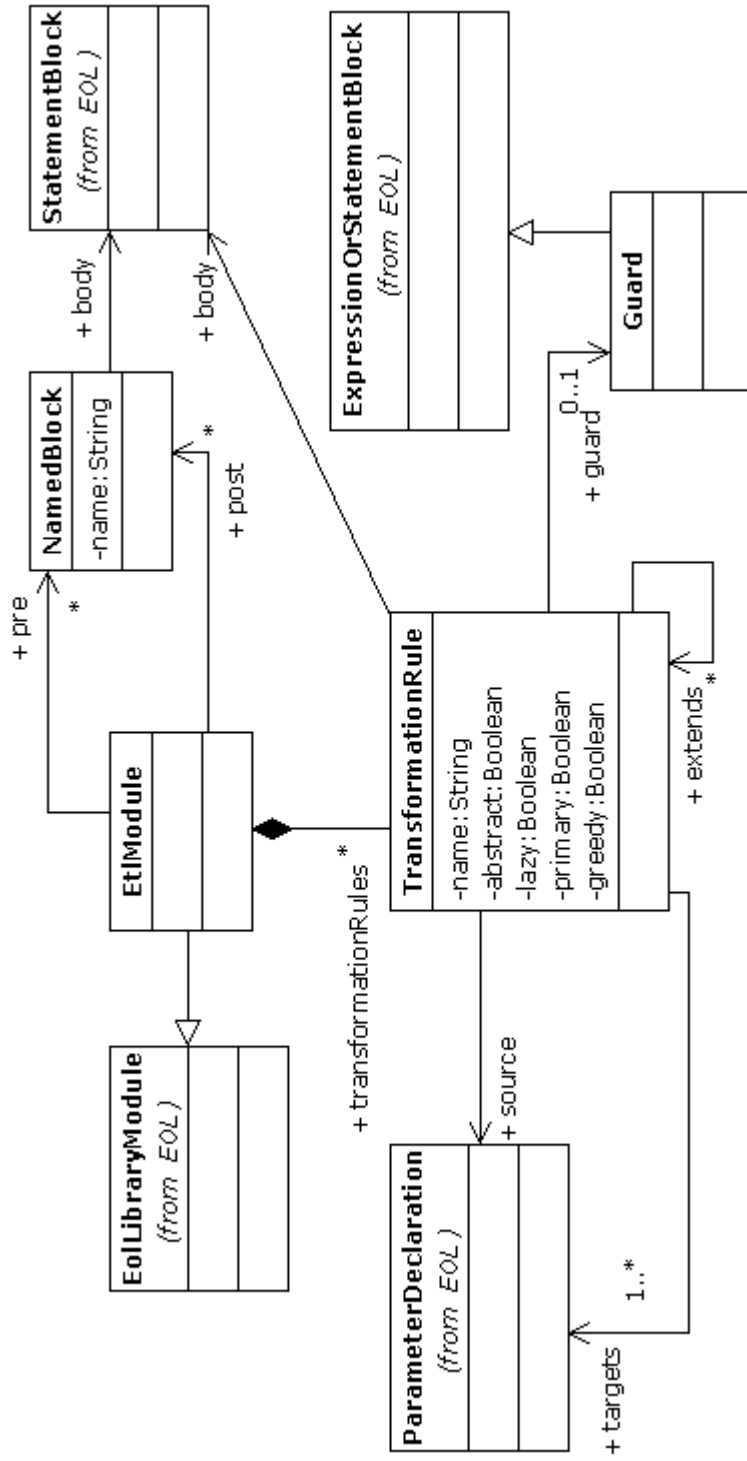

Figure 5.1: ETL Abstract Syntax

defined after the *transform* and *to* keywords. Also, the rule can define an optional comma-separated list of rules it extends after the *extends* keyword. Inside the curly braces ({}), the rule can optionally specify its *guard* either as an EOL expression following a colon (:) (for simple guards) or as a block of statements in curly braces (for more complex guards). Finally, the *body* of the rule is specified as a sequence of EOL statements.

```

1  (@abstract)?
2  (@lazy)?
3  (@primary)?
4  rule <name>
5     transform <sourceParameterName>:<sourceParameterType>
6     to <rightParameterName>:<rightParameterType>
7         (<rightParameterName>:<rightParameterType>)*
8     (extends <ruleName>(, <ruleName>)*)? {
9
10    (guard (:expression) | ({statementBlock}))?
11
12    statement+
13 }
```

Listing 5.1: Concrete Syntax of a TransformationRule

*Pre* and *post* blocks have a simple syntax that, as presented in Listing 5.2, consists of the identifier (*pre* or *post*), an optional name and the set of statements to be executed enclosed in curly braces.

```

1  (pre | post) <name> {
2     statement+
3 }
```

Listing 5.2: Concrete Syntax of Pre and Post blocks

## 5.5 Execution Semantics

### 5.5.1 Rule and Block Overriding

Similarly to ECL, an ETL module can import a number of other ETL modules. In this case, the importing ETL module inherits all the rules and pre/post blocks specified in the modules it imports (recursively). If the module specifies a rule or a pre/post block with the same name, the local rule/block overrides the imported one respectively.

## 5.5.2 Rule Execution Scheduling

When an ETL module is executed, the *pre* blocks of the module are executed first in the order in which they have been specified.

Following that, each *non-abstract* and *non-lazy* rule is executed for all the elements on which it is applicable. To be applicable on a particular element, the element must have a type-of relationship with the type defined in the rule's *sourceParameter* (or a kind-of relationship if the rule is annotated as *@greedy*) and must also satisfy the *guard* of the rule (and all the rules it extends). When a rule is executed on an applicable element, the target elements are initially created by instantiating the *targetParameters* of the rules, and then their contents are populated using the EOL statements of the *body* of the rule.

Finally, when all rules have been executed, the *post* blocks of the module are executed in the order in which they have been declared.

## 5.5.3 Source Elements Resolution

Resolving target elements that have (or can be) transformed from source elements by other rules is a frequent task in the body of a transformation rule. To automate this task and reduce coupling between rules, ETL contributes the *equivalents()* and *equivalent()* built-in operations that automatically resolve source elements to their transformed counterparts in the target models.

When the *equivalents()* operation is applied on a single source element (as opposed to a collection of them), it inspects the established transformation trace (displayed in Figure 5.2) and invokes the applicable rules (if necessary) to calculate the counterparts of the element in the target model. When applied to a collection it returns a *Bag* containing *Bags* that in turn contain the counterparts of the source elements contained in the collection. The *equivalents()* operation can be also invoked with an arbitrary number of rule names as parameters to invoke and return only the equivalents created by specific rules. Unlike the main execution scheduling scheme discussed above, the *equivalents()* operation invokes both *lazy* and *non-lazy* rules. It is worth noting that *lazy* rules are computationally expensive and should be used with caution as they can significantly degrade the performance of the overall transformation.

With regard to the ordering of the results of the *equivalents()* operations, the returned elements appear in the respective order of the rules that have created them. An exception to this occurs when one of the rules is declared as *primary*, in which case its results precede the results of all other rules.

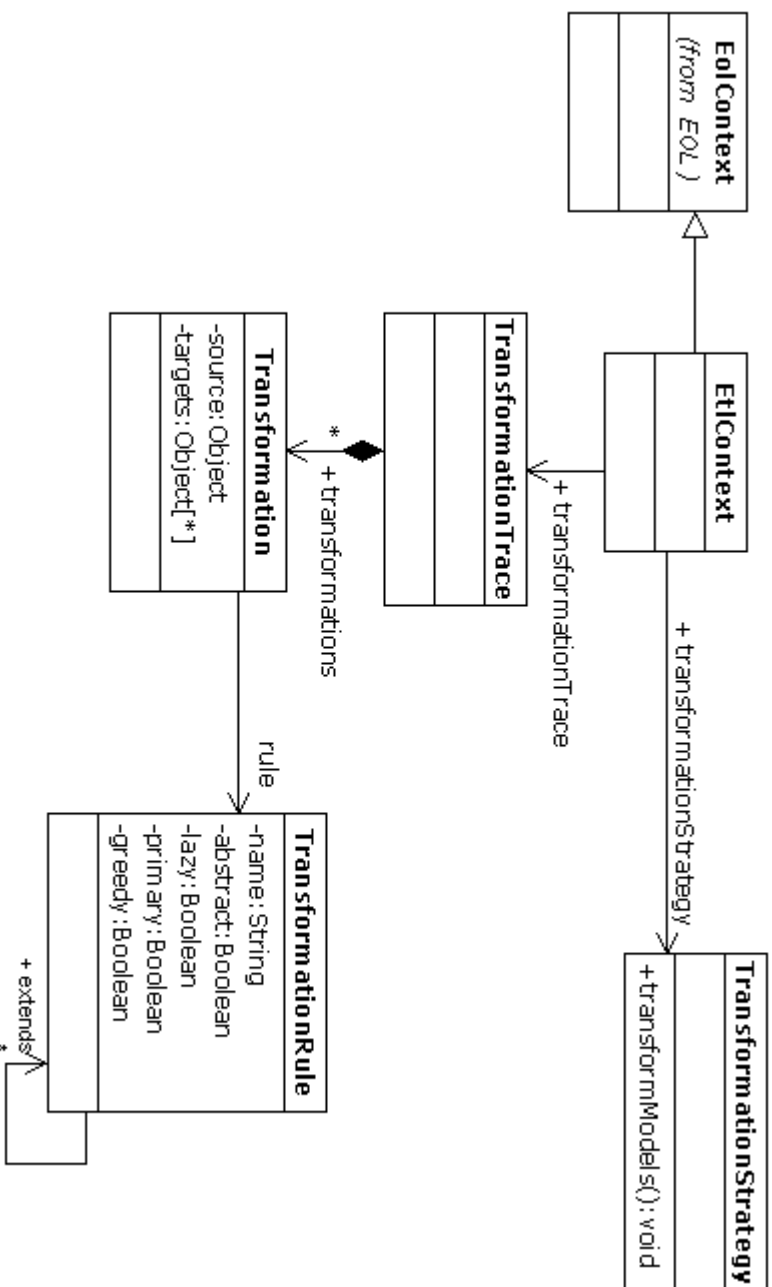

Figure 5.2: ETL Runtime



ETL also provides the convenience *equivalent()* operation which, when applied to a single element, returns only the first element of the respective result that would have been returned by the *equivalents()* operation discussed above. Also, when applied to a collection the *equivalent()* operation returns a flattened collection (as opposed to the result of *equivalents()* which is a *Bag of Bags* in this case). As with the *equivalents()* operation, the *equivalent()* operation can also be invoked with or without parameters.

The semantics of the *equivalent()* operation are further illustrated through a simple example. In this example, we need to transform a model that conforms to the *Tree* meta-model displayed in Figure 8.3 into a model that conforms to the *Graph* metamodel of Figure 5.3. More specifically, we need to transform each *Tree* element to a *Node*, and an *Edge* that connects it with the *Node* that is equivalent to the tree's *parent*. This is achieved using the rule of Listing 5.3.

```

1 rule Tree2Node
2   transform t : Tree!Tree
3   to n : Graph!Node {
4
5     n.label = t.label;
6
7     if (t.parent.isDefined()) {
8       var edge = new Graph!Edge;
9       edge.source = n;
10      edge.target = t.parent.equivalent();
11    }
12  }

```

Listing 5.3: Exemplar ETL Rule demonstrating the *equivalent()* operation

In lines 1–3, the *Tree2Node* rule specifies that it can transform elements of the *Tree* type in the *Tree* model into elements of the *Node* type in the *Graph* model. In line 5 it specifies that the name of the created *Node* should be the same as the name of the source *Tree*. If the parent of the source *Tree* is defined (line 7), the rule creates a new *Edge* (line 8) and sets its *source* property to the created *Node* (line 9) and its *target* property to the *equivalent Node* of the source *Tree's parent* (line 10).

## 5.5.4 Overriding the semantics of the EOL SpecialAssignmentOperator

As discussed above, resolving the *equivalent(s)* or source model elements in the target model is a recurring task in model transformation. Furthermore, in most cases resolving the *equivalent* of a model element is immediately followed by assigning/adding the

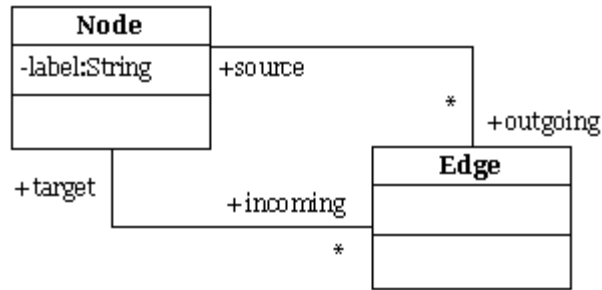

Figure 5.3: A Simple Graph Metamodel

obtained target model elements to the value(s) of a property of another target model element. For example, in line 10 of Listing 5.3 the *equivalent* obtained is immediately assigned to the *target* property of the generated *Edge*. To make transformation specifications more readable, ETL overrides the semantics of the *SpecialAssignmentStatement* (`::=` in terms of concrete syntax), described in Section 3.5.3 to set its left-hand side, not to the element its right-hand side evaluates to, but to its *equivalent* as calculated using the *equivalent()* operation discussed above. Using this feature, line 10 of the *Tree2Node* rule can be rewritten as shown in Listing 5.4

```
1 edge.target ::= t.parent;
```

Listing 5.4: Rewritten Line 10 of the *Tree2Node* Rule Demonstrated in Listing 5.3

## 5.6 Interactive Transformations

Using the user interaction facilities of EOL discussed in Section 3.7, an ETL transformation can become interactive by prompting the user for input during its execution. For example in Listing 5.5, we modify the *Tree2Node* rule originally presented in Listing 5.3 by adding a *guard* part that uses the user-input facilities of EOL (more specifically the *UserInput.confirm(String,Boolean)* operation) to enable the user select manually at runtime which of the *Tree* elements need to be transformed to respective *Node* elements in the target model and which not.

```

1 rule Tree2Node
2   transform t : Tree!Tree
3   to n : Graph!Node {
4
5     guard : UserInput.confirm
6       ("Transform tree " + t.label + "?", true)
7
  
```

```
8 n.label = t.label;
9 var target : Graph!Node ::= t.parent;
10 if (target.isDefined()) {
11     var edge = new Graph!Edge;
12     edge.source = n;
13     edge.target = target;
14 }
15 }
```

Listing 5.5: Exemplar Interactive ETL Transformation

## 5.7 Summary

This section has provided a detailed discussion on the Epsilon Transformation Language (ETL). ETL is capable of transforming an arbitrary number of source models into an arbitrary number of target models. ETL adopts a hybrid style and features declarative rule specification using advanced concepts such as *guards*, *abstract*, *lazy* and *primary* rules, and automatic resolution of target elements from their source counterparts. Also, as ETL is based on EOL reuses its imperative features to enable users to specify particularly complex, and even interactive, transformations.



## Chapter 6

# The Epsilon Wizard Language (EWL)

There are two types of model-to-model transformations: mapping and update transformations [8]. Mapping transformations typically transform a source model into a set of target models expressed in (potentially) different modelling languages by creating zero or more model elements in the target models for each model element of the source model. By contrast, update transformations perform in-place modifications in the source model itself. They can be further classified into two subcategories: transformations in the small and in the large. Update transformations in the large apply to sets of model elements calculated using well-defined rules in a batch manner. An example of this category of transformations is a transformation that automatically adds accessor and mutator operations for all attributes in a UML model. On the other hand, update transformations in the small are applied in a user-driven manner on model elements that have been explicitly selected by the user. An example of this kind of transformations is a transformation that renames a *user-specified* UML class and all its incoming associations consistently.

In Epsilon, mapping transformations can be specified using ETL as discussed in Section 5, and update transformations in the large can be implemented either using the model modification features of EOL or using an ETL transformation in which the source and target models are the same model. By contrast, update transformations in the small cannot be effectively addressed by any of the languages presented so far.

The following section discusses the importance of update transformations in the small and motivates the definition of a task-specific language (Epsilon Wizard Language (EWL)) that provides tailored and effective support for defining and executing update transformations on models of diverse metamodels.

## 6.1 Motivation

Constructing and refactoring models is undoubtedly a mentally intensive process. However, during modelling, recurring patterns of model update activities typically appear. As an example, when renaming a class in a UML class diagram, the user also needs to manually update the names of association ends that link to the renamed class. Thus, when renaming a class from *Chapter* to *Section*, all associations ends that point to the class and are named *chapter* or *chapters* should be also renamed to *section* and *sections* respectively. As another example, when a modeller needs to refactor a UML class into a singleton [2], they need to go through a number of well-defined, but trivial, steps such as attaching a stereotype (`<< singleton >>`), defining a static *instance* attribute and adding a static *getInstance()* method that returns the unique instance of the singleton.

It is generally accepted that performing repetitive tasks manually is both counter-productive and error-prone [9]. On the other hand, failing to complete such tasks correctly and precisely compromises the consistency, and thus the quality, of the models. In Model Driven Engineering, this is particularly important since models are increasingly used to automatically produce (parts of) working systems.

### 6.1.1 Automating the Construction and Refactoring Process

Contemporary modelling tools provide built-in transformations (*wizards*) for automating common repetitive tasks. However, according to the architecture of the designed system and the specific problem domain, additional repetitive tasks typically appear, which cannot be addressed by the pre-conceived built-in wizards of a modelling tool. To address the automation problem in its general case, users must be able to easily define update transformations (*wizards*) that are tailored to their specific needs.

To an extent, this can be achieved via the extensible architecture that state-of-the-art modelling tools often provide and which enables users to add functionality to the tool via scripts or application code using the implementation language of the tool. Nevertheless, as discussed in [10], the majority of modelling tools provide an API through which they expose an edited model, which requires significant effort to learn and use. Also, since each API is proprietary, such scripts and extensions are not portable to other tools. Finally, API scripting languages and third-generation languages such as Java and C++ are not particularly suitable for model navigation and modification [10].

Furthermore, existing languages for mapping transformations, such as QVT, ATL and ETL, cannot be used as-is for this purpose, because these languages have been designed

to operate in a batch manner without human involvement in the process. By contrast, as discussed above, the task of constructing and refactoring models is inherently user-driven.

## 6.2 Update Transformations in the Small

Update transformations are actions that automatically create, update or delete model elements based on a selection of existing elements in the model and information obtained otherwise (e.g. through user input), in a user-driven fashion. In this section such actions are referred to as *wizards* instead of *rules* to reduce confusion between them and rules of mapping transformation languages. In the following sections the desirable characteristics of wizards are elaborated informally.

### 6.2.1 Structure of Wizards

In its simplest form, a wizard only needs to define the actions it will perform when it is applied to a selection of model elements. The structure of such a wizard that transforms a UML class into a *singleton* is shown using pseudo-code in Listing 6.1.

```
1 do :
2   attach the singleton stereotype
3   create the instance attribute
4   create the getInstance method
```

Listing 6.1: The simplest form of a wizard for refactoring a class into a singleton

Since not all wizards apply to all types of elements in the model, each wizard needs to specify the types of elements to which it applies. For example, the wizard of Listing 6.1, which automatically transforms a class into a singleton, applies only when the selected model element is a class. The simplest approach to ensuring that the wizard will only be applied on classes is to enclose its body in an *if* condition as shown in Listing 6.2.

```
1 do :
2   if (selected element is a class) {
3     attach the singleton stereotype
4     create the instance attribute
5     create the getInstance method
6   }
```

Listing 6.2: The wizard of Listing 6.1 enhanced with an *if* condition

A more modular approach is to separate this condition from the body of the wizard. This is shown in Listing 6.3 where the condition of the wizard is specified as a separate

*guard* stating that the wizard applies only to elements of type `Class`. The latter is preferable since it enables filtering out wizards that are not applicable to the current selection of elements by evaluating only their *guard* parts and rejecting those that return *false*. Thus, at any time, the user can be provided with only the wizards that are applicable to the current selection of elements. Filtering out irrelevant wizards reduces confusion and enhances usability, particularly as the list of specified wizards grows.

```
1 guard : selected element is a class
2 do :
3   attach the singleton stereotype
4   create the instance attribute
5   create the getInstance method
```

Listing 6.3: The wizard of Listing 6.2 with an explicit *guard* instead of the *if* condition

To enhance usability, a wizard also needs to define a short human-readable description of its functionality. To achieve this, another field named *title* has been added. There are two options for defining the title of a wizard: the first is to use a static string and the second to use a dynamic expression. The latter is preferable since it enables definition of context-aware titles.

```
1 guard : selected element is a class
2 title : Convert class <class-name> into a singleton
3 do :
4   attach the singleton stereotype
5   create the instance attribute
6   create the getInstance method
```

Listing 6.4: The wizard of Listing 6.3 enhanced with a *title* part

## 6.2.2 Capabilities of Wizards

The *guard* and *title* parts of a wizard need to be expressed using a language that provides model querying and navigation facilities. Moreover, the *do* part also requires model modification capabilities to implement the transformation. To achieve complex transformations, it is essential that the user can provide additional information. For instance, to implement a wizard that addresses the class renaming scenario discussed in Section 6.1, the information provided by the selected class does not suffice; the user must also provide the new name of the class. Therefore, EWL must also provide mechanisms for capturing user input.



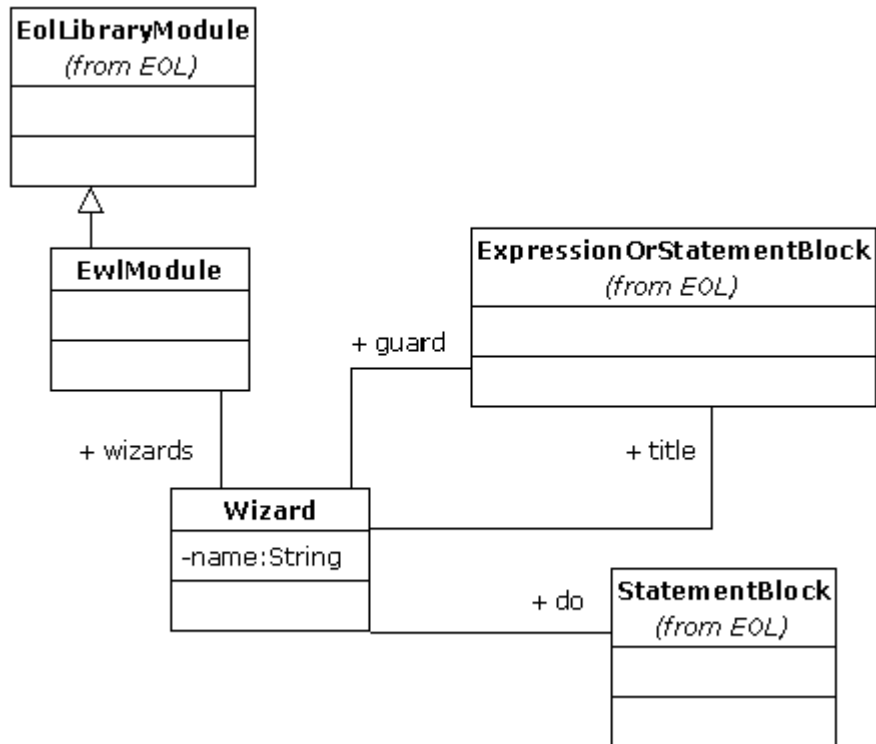

Figure 6.1: EWL Abstract Syntax

### 6.3 Abstract Syntax

Since EWL is built atop Epsilon, its abstract and concrete syntax need only to define the concepts that are relevant to the task it addresses; they can reuse lower-level constructs from EOL. A graphical overview of the abstract syntax of the language is provided in Figure 6.1.

The basic concept of the EWL abstract syntax is a *Wizard*. A wizard defines a *name*, a *guard* part, a *title* part and a *do* part. Wizards are organized in *Modules*. The *name* of a wizard acts as an identifier and must be unique in the context of a module. The *guard* and *title* parts of a wizard are of type *ExpressionOrStatementBlock*, inherited from EOL. An *ExpressionOrStatementBlock* is either a single EOL expression or a block of EOL statements that include one or more *return* statements. This construct allows users to express simple declarative calculations as single expressions and complex calculations as blocks of imperative statements. The usefulness of this construct is further discussed in the examples presented in Section 6.6. Finally, the *do* part of the wizard is a block of EOL statements that specify the effects of the wizard when applied to a compatible selection of model elements.

## 6.4 Concrete Syntax

Listing 6.5 presents the concrete syntax of EWL wizards.

```
1 wizard <name> {  
2   (guard (:expression) | ({statementBlock}))?  
3   (title (:expression) | ({statementBlock}))?  
4   do {  
5     statementBlock  
6   }  
7 }
```

Listing 6.5: Concrete syntax of EWL wizards

## 6.5 Execution Semantics

The process of executing EWL wizards is inherently user-driven and as such it depends on the environment in which they are used. In general, each time the selection of model elements changes (i.e. the user selects or deselects a model element in the modelling tool), the guards of all wizards are evaluated. If the guard of a wizard is satisfied, the *title* part is also evaluated and the wizard is added to a list of *applicable* wizards. Then, the user can select a wizard and execute its *do* part to perform the intended transformation.

In EWL, variables defined and initialized in the *guard* part of the wizard can be accessed both by the *title* and the *do* parts. In this way, results of calculations performed in the *guard* part can be re-used, instead of re-calculated in the subsequent parts. The practicality of this approach is discussed in more detail in the examples that follow. Also, the execution of the *do* part of each wizard is performed in a transactional mode by exploiting the transaction capabilities of the underlying model connectivity framework, so that possible logical errors in the *do* part of a wizard do not leave the edited model in an inconsistent state.

## 6.6 Examples

This section presents three concrete examples of EWL wizards for refactoring UML 1.4 models. The aim of this section is not to provide complete implementations that address all the sub-cases of each scenario but to provide enhanced understanding of the concrete syntax, the features and the capabilities of EWL to the reader. Moreover, it should be stressed again that although the examples in this section are based on UML models, by building on Epsilon, EWL can be used to capture wizards for diverse modelling languages and technologies.

## Converting a Class into a Singleton

The singleton pattern [2] is applied when there is a class for which only one instance can exist at a time. In terms of UML, a singleton is a class stereotyped with the `<< singleton >>` stereotype, and it defines a static attribute named *instance* which holds the value of the unique instance. It also defines a static *getInstance()* operation that returns that unique instance. Wizard *ClassToSingleton*, presented in Listing 6.6, simplifies the process of converting a class into a singleton by adding the proper stereotype, attribute and operation to it automatically.

```
1 wizard ClassToSingleton {
2
3   // The wizard applies when a class is selected
4   guard : self.isTypeOf(Class)
5
6   title : "Convert " + self.name + " to a singleton"
7
8   do {
9     // Create the getInstance() operation
10    var gi : new Operation;
11    gi.owner = self;
12    gi.name = "getInstance";
13    gi.visibility = VisibilityKind#vk_public;
14    gi.ownerScope = ScopeKind#sk_classifier;
15
16    // Create the return parameter of the operation
17    var ret : new Parameter;
18    ret.type = self;
19    ret.kind = ParameterDirectionKind#pdk_return;
20    gi.parameter = Sequence{ret};
21
22    // Create the instance field
23    var ins : new Attribute;
24    ins.name = "instance";
25    ins.type = self;
26    ins.visibility = VisibilityKind#vk_private;
27    ins.ownerScope = ScopeKind#sk_classifier;
28    ins.owner = self;
29
30    // Attach the <<singleton>> stereotype
31    self.attachStereotype("singleton");
32  }
33 }
```

```

34
35 // Attaches a stereotype with the specified name
36 // to the Model Element on which it is invoked
37 operation ModelElement attachStereotype(name : String) {
38     var stereotype : Stereotype;
39
40     // Try to find an existing stereotype with this name
41     stereotype = Stereotype.allInstances.selectOne(s|s.name = name);
42
43     // If there is no existing stereotype
44     // with that name, create one
45     if (not stereotype.isDefined()){
46         stereotype = Stereotype.createInstance();
47         stereotype.name = name;
48         stereotype.namespace = self.namespace;
49     }
50
51     // Attach the stereotype to the model element
52     self.stereotype.add(stereotype);
53 }

```

Listing 6.6: Implementation of the ClassToSingleton Wizard

The *guard* part of the wizard specifies that it is only applicable when the selection is a single UML class. The *title* part specifies a context-aware title that informs the user of the functionality of the wizard and the *do* part implements the functionality by adding the *getInstance* operation (lines 10-14), the *instance* attribute (lines 23-28) and the <<*singleton*>> stereotype (line 31).

The stereotype is added via a call to the *attachStereotype()* operation. Attaching a stereotype is a very common action when refactoring UML models, particularly where UML profiles are involved, and therefore to avoid duplication, this reusable operation that checks for an existing stereotype, creates it if it does not already exist, and attaches it to the model element on which it is invoked has been specified.

An extended version of this wizard could also check for existing association ends that link to the class and for which the upper-bound of their multiplicity is greater than one and either disallow the wizard from executing on such classes (in the *guard* part) or update the upper-bound of their multiplicities to one (in the *do* part). However, the aim of this section is not to implement complete wizards that address all sub-cases but to provide a better understanding of the concrete syntax and the features of EWL. This principle also applies to the examples presented in the sequel.

## Renaming a Class

The most widely used convention for naming attributes and association ends of a given class is to use a lower-case version of the name of the class as the name of the attribute or the association end. For instance, the two ends of a one-to-many association that links classes `Book` and `Chapter` are most likely to be named `book` and `chapters` respectively. When renaming a class (e.g. from `Chapter` to `Section`) the user must then manually traverse the model to find all attributes and association ends of this type and update their names (i.e. from `chapter` or `bookChapter` to `section` and `bookSection` respectively). This can be a daunting process especially in the context of large models. Wizard `RenameClass` presented in Listing 6.7 automates this process.

```
1 wizard RenameClass {
2
3   // The wizard applies when a Class is selected
4   guard : self.isKindOf(Class)
5
6   title : "Rename class " + self.name
7
8   do {
9     var newName : String;
10
11     // Prompt the user for the new name of the class
12     newName = UserInput.prompt("New name for class " + self.name);
13     if (newName.isDefined()) {
14       var affectedElements : Sequence;
15
16       // Collect the AssociationEnds and Attributes
17       // that are affected by the rename
18       affectedElements.addAll(
19         AssociationEnd.allInstances.select(ae|ae.participant=self));
20       affectedElements.addAll(
21         Attribute.allInstances.select(a|a.type = self));
22
23       var oldNameToLower : String;
24       oldNameToLower = self.name.firstToLowerCase();
25       var newNameToLower : String;
26       newNameToLower = newName.firstToLowerCase();
27
28       // Update the names of the affected AssociationEnds
29       // and Attributes
30       for (ae in affectedElements) {
31         ae.replaceInName(oldNameToLower, newNameToLower);
```

```

32     ae.replaceInName(self.name, newName);
33     }
34     self.name = newName;
35     }
36 }
37
38 }
39
40 // Renames the ModelElement on which it is invoked
41 operation ModelElement replaceInName
42     (oldString : String, newString : String) {
43
44     if (oldString.isSubstringOf(self.name)) {
45         // Calculate the new name
46         var newName : String;
47         newName = self.name.replace(oldString, newString);
48
49         // Prompt the user for confirmation of the rename
50         if (UserInput.confirm
51             ("Rename " + self.name + " to " + newName + "?")) {
52             // Perform the rename
53             self.name = newName;
54         }
55     }
56 }

```

Listing 6.7: Implementation of the RenameClass Wizard

As with the `ClassToSingleton` wizard, the guard part of `RenameClass` specifies that the wizard is applicable only when the selection is a simple class and the *title* provides a context-aware description of the functionality of the wizard.

As discussed in Section 6.2, the information provided by the selected class itself does not suffice in the case of renaming since the new name of the class is not specified anywhere in the existing model. In EWL, and in all languages that build on EOL, user input can be obtained using the built-in `UserInput` facility. Thus, in line 12 the user is prompted for the new name of the class using the `UserInput.prompt()` operation. Then, all the association ends and attributes that refer to the class are collected in the `affectedElements` sequence (lines 14-21). Using the `replaceInName` operation (lines 31 and 32), the name of each one is examined for a substring of the upper-case or the lower-case version of the old name of the class. In case the check returns true, the user is prompted to confirm (line 48) that the feature needs to be renamed. This further highlights the importance of user input for implementing update transformations with fine-grained user control.

## Moving Model Elements into a Different Package

A common refactoring when modelling in UML is to move model elements, particularly Classes, between different packages. When moving a pair of classes from one package to another, the associations that connect them must also be moved in the target package. To automate this process, Listing 6.8 presents the `MoveToPackage` wizard.

```
1 wizard MoveToPackage {
2
3 // The wizard applies when a Collection of
4 // elements, including at least one Package
5 // is selected
6 guard {
7     var moveTo : Package;
8     if (self.isKindOf(Collection)) {
9         moveTo = self.select(e|e.isKindOf(Package)).last();
10    }
11    return moveTo.isDefined();
12 }
13
14 title : "Move " + (self.size()-1) + " elements to " + moveTo.name
15
16 do {
17     // Move the selected Model Elements to the
18     // target package
19     for (me in self.excluding(moveTo)) {
20         me.namespace = moveTo;
21     }
22
23     // Move the Associations connecting any
24     // selected Classes to the target package
25     for (a in Association.allInstances) {
26         if (a.connection.forAll(c|self.includes(c.participant))){
27             a.namespace = moveTo;
28         }
29     }
30 }
31
32 }
```

Listing 6.8: Implementation of the `MoveToPackage` Wizard

The wizard applies when more than one element is selected and at least one of the elements is a *Package*. If more than one package is selected, the last one is considered

as the target package to which the rest of the selected elements will be moved. This is specified in the *guard* part of the wizard.

To reduce user confusion in identifying the package to which the elements will be moved, the name of the target package appears in the title of the wizard. This example shows the importance of the decision to express the title as a dynamically calculated expression (as opposed to a static string). It is worth noting that in the *title* part of the wizard (line 14), the *moveTo* variable declared in the *guard* (line 7) is referenced. Through experimenting with a number of wizards, it has been noticed that in complex wizards repeated calculations need to be performed in the *guard*, *title* and *do* parts of the wizard. To eliminate this duplication, the scope of variables defined in the *guard* part has been extended so that they are also accessible from the *title* and *do* part of the wizard.

## 6.7 Summary

This section has presented the Epsilon Wizard Language (EWL), a language for specifying and executing update transformations in the small on models of diverse metamodels. EWL provides a textual concrete syntax tailored to the task and features such as dynamically calculated wizard titles, transactional execution of the *do* parts of wizards and user interaction.



# Chapter 7

## The Epsilon Generation Language (EGL)

EGL provides a language tailored for model-to-text transformation (M2T). EGL can be used to transform models into various types of textual artefact, including executable code (e.g. Java), reports (e.g. in HTML), images (e.g. using DOT), formal specifications (e.g. Z notation), or even entire applications comprising code in multiple languages (e.g. HTML, Javascript and CSS).

EGL is a *template-based* code generator (i.e. EGL programs resemble the text that they generate), and provides several features that simplify and support the generation of text from models, including: a sophisticated and language-independent merging engine (for preserving hand-written sections of generated text), an extensible template system (for generating text to a variety of sources, such as a file on disk, a database server, or even as a response issued by a web server), formatting algorithms (for producing generated text that is well-formatted and hence readable), and traceability mechanisms (for linking generated text with source models).

### 7.1 Abstract Syntax

Figure 7.1 depicts the abstract syntax of EGL's core functionality.

Conceptually, an EGL program comprises one or more *sections*. The contents of static sections are emitted verbatim and appear directly in the generated text. The contents of dynamic sections are executed and are used to control the text that is generated.

In its dynamic sections, EGL re-uses EOL's mechanisms for structuring program control flow, performing model inspection and navigation, and defining custom operations. In addition, EGL provides an EOL object, `out`, which is used in dynamic sections to perform operations on the generated text, such as appending and removing strings; and specifying the type of text to be generated.

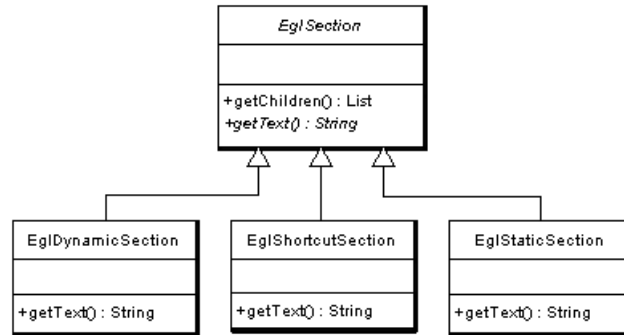

Figure 7.1: The abstract syntax of EGL’s core.

```

1 [% for (i in Sequence{1..5}) { %]
2 i is [%=i%]
3 [% } %]
  
```

Listing 7.1: A basic EGL template.

```

1 i is 1
2 i is 2
3 i is 3
4 i is 4
5 i is 5
  
```

Listing 7.2: The text generated from the basic EGL template (Listing 7.1).

EGL also provides syntax for defining *dynamic output* sections, which provide a convenient shorthand for outputting text from within dynamic sections. Similar syntax is often provided by template-based code generators.

## 7.2 Concrete Syntax

The concrete syntax of EGL closely resembles the style of other template-based code generation languages, such as PHP. The tag pair `[% %]` is used to delimit a dynamic section. Any text not enclosed in such a tag pair is contained in a static section. Listing 7.1 illustrates the use of dynamic and static sections to form a basic EGL template.

Executing the EGL template in Listing 7.1 would produce the generated text in Listing 7.2. The `[%=expr%]` construct (line 2) is shorthand for `[% out.print(expr); %]`, which appends `expr` to the output generated by the transformation.

Any EOL statement can be contained in the dynamic sections of an EGL template. For example, the EGL template depicted in Listing 7.3 generates text from a model that

```

1 [% for (c in Class.all) { %]
2 [%=c.name%]
3 [% } %]

```

Listing 7.3: Generating the name of each Class contained in an input model.

conforms to a metamodel that describes an object-oriented system.

## 7.2.1 Comments and Markers

Inside an EGL dynamic section, EOL's comment syntax can be used. Additionally, EGL adds syntax for comment blocks [`* this is a comment *`] and marker blocks [`*- this is a marker *`]. Marker blocks are highlighted by the EGL editor and EGL outline view in Eclipse.

## 7.2.2 User-Defined Operations

Like EOL, EGL permits users to define re-usable units of code via operations (Section 3.2). EGL operations support the predefined annotations for regular EOL operations, such as optional pre-/post-conditions (Section 3.2.2) or result caching (Section 3.2.3).

```

1 [% c.declaration(); %]
2 [% operation Class declaration() { %]
3 [%=self.visibility%] class [%=self.name%] {}
4 [% } %]

```

Listing 7.4: Using an operation to specify the text generated for a declaration of a Java class.

In EGL, user-defined operations are defined in dynamic sections, but may mix static and dynamic sections in their bodies. Consider, for example, the EGL code in Listing 7.4, which emits a declaration for a Java class (e.g. `public class Foo {}`). Lines 2-4 declare the operation. Note that the start and the end of the operation's declaration (on lines 2 and 4, respectively) are contained in dynamic sections. The body of the operation (line 3), however, mixes static and dynamic output sections. Finally, note that the operation is invoked from a dynamic section (line 1). It is worth noting that any loose (i.e. not contained in other operations) dynamic or static sections below the first operation of a template will be ignored at runtime.

When a user-defined operation is invoked, any static or dynamic sections contained in the body of the operation are immediately appended to the generated text. Sometimes,

however, it is desirable to manipulate the text produced by an operation before it is appended to the generated text. To this end, EGL defines the `@template` annotation which can be applied to operations to indicate that any text generated by the operation must be returned from the operation and not appended to the generated text. For example, the EGL program in Listing 7.4 could be rewritten using a `@template` annotation, as demonstrated in Listing 7.5.

```
1 [%=c.declaration()%]
2 [% @template
3   operation Class declaration() { %]
4 [%=self.visibility%] class [%=self.name%] {}
5 [% } %]
```

Listing 7.5: Using a template operation to specify the text generated for a declaration of a Java class.

There is a subtle difference between the way in which standard (i.e. unannotated) operations and `@template` operations are invoked. Compare the first line of Listings 7.4 and 7.5. The former uses a dynamic section, because invoking the operation causes the evaluation of its body to be appended to the text generated by this program. By contrast, the latter uses a dynamic output section to append the result returned by the `@template` operation to the text generated by this program.

In general, `@template` operations afford more flexibility than standard operations. For example, line 1 of Listing 7.5 could perform some manipulation of the text returned by the `declaration()` operation before the text is outputted. Therefore, `@template` operations provide a mechanism for re-using common pieces of a code generator, without sacrificing the flexibility to slightly alter text before it is emitted. Standard (unannotated) operations also permit re-use, but in a less flexible manner.

Finally, it is worth noting that user-defined operations in EGL do not have to generate text. For example, Listing 7.6 illustrates two operations defined in an EGL program that do not generate any text. The former is a query that returns a Boolean value, while the latter alters the model, and does not return a value.

## 7.3 The OutputBuffer

As an EGL program is executed, text is appended to a data structure termed the *OutputBuffer*. In every EGL program, the *OutputBuffer* is accessible via the `out` built-in variable. The *OutputBuffer* provides operations for appending to and removing from the buffer, and for merging generated text with existing text (see Section 7.5).

```

1 [%
2 operation Class isAnonymous() : Boolean {
3   return self.name.isUndefined();
4 }
5
6 operation removeOneClass() {
7   delete Class.all.random();
8 }
9 %]

```

Listing 7.6: Operations that do not generate any text.

For many EGL programs, interacting directly with the *OutputBuffer* is unnecessary. The contents of static and dynamic output sections are sent directly to the *OutputBuffer*, and no operation of the *OutputBuffer* need be invoked directly. However, in cases when generated text must be sent to the *OutputBuffer* from dynamic sections, or when generated text must be merged with existing text, the operations of *OutputBuffer* (Table 7.1) are provided. Section 7.5 discusses merging generated and existing text, and presents several examples of invoking the operations of *OutputBuffer*.

Table 7.1: Operations of type *OutputBuffer*

Signature	Description
chop(numberOfChars : Integer)	Removes the specified number of characters from the end of the buffer
print(object : Any)	Appends a string representation of the specified object to the buffer
println(object : Any)	Appends a string representation of the specified object and a new line to the buffer
println()	Appends a new line to the buffer
setContentTypes(contentTypes : List<String>)	Updates the content type of this template. Subsequent calls to <code>preserve</code> or <code>startPreserve</code> that do not specify a style of comment will use the style of comment defined by the specified content type. See Section 7.5.

<code>preserve(id : String, enabled : Boolean, contents : String)</code>	Appends a protected region to the buffer with the given identifier, enabled state and contents. Uses the current content type to determine how to format the start and end markers. See Section 7.5.
<code>preserve(startComment : String, endComment : String, id : String, enabled : Boolean, contents : String)</code>	Appends a protected region to the buffer with the given identifier, enabled state and contents. Uses the first two parameters as start and end markers. See Section 7.5.
<code>startPreserve(id : String, enabled : Boolean)</code>	Begins a protected region by appending the start marker for a protected region to the buffer with the given identifier and enabled state. Uses the current content type to determine how to format the start and end markers. See Section 7.5.
<code>startPreserve(startComment : String, endComment : String, id : String, enabled : Boolean)</code>	Begins a protected region by appending the start marker to the buffer with the given identifier and enabled state. Uses the first two parameters as start and end markers. See Section 7.5.
<code>stopPreserve()</code>	Ends the current protected region by appending the end marker to the buffer. This operation should be invoked only if there a protected region is currently open (i.e. has been started by invoking <code>startPreserve</code> but not yet stopped by invoking <code>stopPreserve</code> ). See Section 7.5.

## 7.4 Co-ordination

In the large, M2T transformations are used to generate text to various destinations. For example, code generators often produce files on disk, and web applications often generate text as part of the response for a resource on the web server. Text might be generated to a network socket during interprocess communication, or as a query that runs on a database. Furthermore, (parts of) a single M2T transformation might be re-used in different contexts. A M2T transformation that generates files on disk today might be re-purposed to generate the response from a web server tomorrow.

Given these concerns, EGL provides a co-ordination engine that provides mechanisms

for modularising M2T transformations, and for controlling the destinations to which text is generated. The EGL co-ordination engine fulfils three requirements:

1. **Reusability:** the co-ordination engine allows EGL programs to be decomposed into one or more templates, which can be shared between EGL programs.
2. **Variety of destination:** the co-ordination engine provides an extensible set of template types that can generate text to a variety of destinations. Section 7.4.1 describes the default template type, which is tailored to generate text to files on disk, while Section 7.4.4 discusses the way in which users can define their own template types for generating text to other types of destination.
3. **Separation of concerns:** the co-ordination engine ensures that the logic for controlling the text that is generated (i.e. the content) and the logic for controlling the way in which text is emitted (i.e. the destination) are kept separate.

### 7.4.1 The Template type

Central to the co-ordination engine is the *Template* type, which EGL provides in addition to the default EOL types (Section 3.3). Via the *Template* type, EGL fulfils the three requirements identified above. Firstly, a *Template* can invoke other *Templates*, and hence can be shared and re-used between EGL programs. Secondly, the *Template* type has been implemented in an extensible manner: users can define their own types of *Template* that generate text to any destination (e.g. a database or a network socket), as described in Section 7.4.4. Finally, the *Template* type provides a set of operations that are used to control the destination of generated text. Users typically define a “driver” template that does not generate text, but rather controls the destination of text that is generated by other templates.

For example, consider the EGL program in Listing 7.7. This template generates no text (as it contains only a single dynamic section), but is used instead to control the destination of text generated by another template. Line 1 defines a variable, `t`, of type *Template*. Note that, unlike the EOL types, instances of *Template* are not created with the `new` keyword. Instead, the *TemplateFactory* built-in object (Section 7.4.2) is used to load templates from, for example, a file system path. On line 3, the *generate* operation of the *Template* type invokes the EGL template stored in the file “ClassNames.egl” and emits the generated text to “Output.txt”.

```

1 [%
2   var t : Template = TemplateFactory.load("ClassNames.egl");
3   t.generate("Output.txt");
4 %]

```

Listing 7.7: Storing the name of each Class to disk.

In addition to `generate`, the `Template` type defines further operations for controlling the context and invocation of EGL templates. Table 7.2 lists all of the operations defined on `Template`, and a further example of their use is given in Section 7.4.3.

Table 7.2: Operations of type `Template`

Signature	Description
<code>populate(name : String, value : Any)</code>	Makes a variable with the specified name and value available during the execution of the template.
<code>process() : String</code>	Executes the template and returns the text that is generated.
<code>generate(destination : String)</code>	Executes the template and stores the text to the specified destination. The format of the destination parameter is dictated by the type of template. For example, the default template type (which can generate files on disk) expects a file system path as the destination parameter. Returns a <code>JAVA.IO.FILE</code> object representing the generated file.
<code>append(destination : String)</code>	Executes the template: if the destination exists, it will add a newline and the generated text at the end of the file. If the file does not exist, it will write the generated text to it (with no newline). Returns a <code>JAVA.IO.FILE</code> object representing the generated file.
<code>setFormatter(formatter : Formatter)</code>	Changes the formatter for this template to the specified formatter. Subsequent calls to <code>generate</code> or <code>process</code> will produce text that is formatted with the specified formatter. See Section 7.6.



setFormatters(formatters : Sequence(Formatter))	: Changes the formatter for this template to the specified sequence of formatters. Subsequent calls to generate or process will produce text that is formatted with each of the specified formatters in turn. See Section 7.6.
-------------------------------------------------	--------------------------------------------------------------------------------------------------------------------------------------------------------------------------------------------------------------------------------

## 7.4.2 The TemplateFactory object

As discussed above, instances of *Template* are not created with the `new` keyword. Instead, EGL provides a built-in object, the *TemplateFactory*, for this purpose. Users can customise the type of the *TemplateFactory* object to gain more control over the way in which text is generated (Section 7.4.4).

By default, EGL provides a *TemplateFactory* that exposes operations for loading templates (by loading files from disk), preparing templates (by parsing a string containing EGL code), and for controlling the file system locations from which templates are loaded and to which text is generated. Table 7.3 lists the operations provided by the built-in *TemplateFactory* object.

Table 7.3: Operations of the TemplateFactory object

Signature	Description
load(path : String) : Template	Returns an instance of <i>Template</i> that can be used to execute the EGL template stored at the specified path.
prepare(code : String) : Template	Returns an instance of <i>Template</i> that can be used to execute the specified EGL code.
setOutputRoot(path : String)	Changes the default path that is used to resolve relative paths when generating files to disk. Subsequent calls to load and prepare will create templates that use the new path.
setTemplateRoot(path : String)	: Changes the default path that is used to resolve relative paths when loading templates with the load operation. Subsequent calls to load will use the new path.

setDefaultFormatter(formatter : Formatter)	Changes the formatter for this template factory to the specified formatter. Templates that are constructed after this operation has been invoked will produce text that is, by default, formatted with the specified formatter. See Section 7.6.
setDefaultFormatters(formatters : Sequence(Formatter))	Changes the formatter for this template to the specified sequence of formatters. Templates that are constructed after this operation has been invoked will produce text that is, by default, formatted with each of the specified formatters in turn. See Section 7.6.

### 7.4.3 An Example of Co-ordination with EGL

The operations provided by the *TemplateFactory* object and *Template* type are demonstrated by the EGL program in Listing 7.8. Lines 2-3 use operations on *TemplateFactory* to change the paths from which templates will be loaded (line 2) and to which generated files will be created (line 3). Line 5 demonstrates the use of the `prepare` operation for creating a template from EGL code. When the `interface` template is invoked, the EGL code passed to the `prepare` operation will be executed. Finally, line 9 (and line 12) illustrates the way in which the `populate` operation can be used to pass a value to a template before invoking it. Specifically, the `interface` and `implementation` templates can use a variable called *root*, which is populated by the driver template before invoking them.

### 7.4.4 Customising the Co-ordination Engine

EGL provides mechanisms for customising the co-ordination engine. Specifically, users can define and use their own *TemplateFactory*. In many cases, users need not customise the co-ordination engine, and can write transformations using the built-in *Template* type and *TemplateFactory* object. If, however, you need more control over the co-ordination process, the discussion in this section might be helpful. Specifically, a custom *TemplateFactory* is typically used to achieve one or more of the following goals:

1. Provide additional mechanisms for constructing *Templates*. **Example:** facilitate the loading of templates from a database.
2. Enrich / change the behaviour of the built-in *Template* type. **Example:** change the way in which generated text is sent to its destination.

```

1 [%
2   TemplateFactory.setTemplateRoot("/usr/franz/templates");
3   TemplateFactory.setOutputRoot("/tmp/output");
4
5   var interface : Template =
6     TemplateFactory.prepare("public interface [%=root.name] {}");
7
8   var implementation : Template =
9     TemplateFactory.load("Class2Impl.egl");
10
11  for (c in Class.all) {
12    interface.populate("root", c);
13    interface.generate("I" + c.name + ".java");
14
15    implementation.populate("root", c);
16    implementation.generate(c.name + ".java");
17  }
18 %]

```

Listing 7.8: Using the various operations provided by the `Template` type and `TemplateFactory` object.

3. Observe or instrument the transformation process by, for instance, logging calls to the operations provided by the `Template` type of the `TemplateFactory` object. **Example:** audit or trace the transformation process.

Customisation is achieved in two stages: implementing the custom `TemplateFactory` (and potentially a custom `Template`) in Java, and using the custom `TemplateFactory`.

### Implementing a custom `TemplateFactory`

A custom `TemplateFactory` is a subclass of `EglTemplateFactory`. Typically, a custom `TemplateFactory` is implemented by overriding one of the methods of `EglTemplateFactory`. For example, the `createTemplate` method is overridden to specify that a custom type of `Template` should be created by the `TemplateFactory`. Likewise, the `load` and `prepare` methods can be overridden to change the location from which `Templates` are constructed.

A custom `Template` is a subclass of `EglTemplate` or, most often, a subclass of `EglPersistentTemplate`. Again, customisation is typically achieved by overriding methods in the superclass, or by adding new methods. For example, to perform auditing activities whenever a template is used to generate text, the `doGenerate` method of `EglPersistentTemplate` is overridden.

```

1  import org.eclipse.epsilon.egl.EglFileGeneratingTemplateFactory;
2  import org.eclipse.epsilon.egl.EglTemplate;
3  import org.eclipse.epsilon.egl.EglPersistentTemplate;
4  import org.eclipse.epsilon.egl.exceptions.EglRuntimeException;
5  import org.eclipse.epsilon.egl.execute.context.IEglContext;
6  import org.eclipse.epsilon.egl.spec.EglTemplateSpecification;
7
8  public class CountingTemplateFactory
9  extends EglFileGeneratingTemplateFactory {
10
11     @Override
12     protected EglTemplate createTemplate(EglTemplateSpecification spec)
13     throws Exception {
14         return new CountingTemplate(spec,
15                                     context,
16                                     getOutputRootOrRoot(),
17                                     outputRootPath);
18     }
19
20     public class CountingTemplate
21     extends EglPersistentTemplate {
22
23         public static int numberOfCallsToGenerate = 0;
24
25         public CountingTemplate(EglTemplateSpecification spec,
26                                 IEglContext context,
27                                 URI outputRoot,
28                                 String outputRootPath)
29         throws Exception {
30             super(spec, context, outputRoot, outputRootPath);
31         }
32
33
34
35         @Override
36         protected void doGenerate(File file,
37                                     String targetName,
38                                     boolean overwrite,
39                                     boolean protectRegions)
40         throws EglRuntimeException {
41             numberOfCallsToGenerate++;
42         }
43     }
44 }

```

Listing 7.9: A simple customisation of the co-ordination engine to count the number of calls to generate().

### Using a custom TemplateFactory

When invoking an EGL program, the user may select a custom *TemplateFactory*. For example, the EGL development tools provide an Eclipse launch configuration that provides

a tab named “Generated Text.” On this tab, users can select a *TemplateFactory* (under the group called “Type of Template Factory”). Note that a *TemplateFactory* only appears on the launch configuration tab if it has been registered with EGL via an Eclipse extension. Similarly, the workflow language provided by Epsilon (Chapter 14) allows the specification of custom types of *TemplateFactory* via the `templateFactoryType` parameter.

## 7.4.5 Summary

The co-ordination engine provided by EGL facilitates the construction of modular and reusable M2T transformations and can be used to generate text to various types of destination. Furthermore, the logic for specifying the contents of generated text is kept separate from the logic for specifying the destination of generated text.

## 7.5 Merge Engine

EGL provides language constructs that allow M2T transformations to designate regions of generated text as *protected*. Whenever an EGL program attempts to generate text, any protected regions that are encountered in the specified destination are preserved.

Within an EGL program, protected regions are specified with the *preserve*(*String*, *String*, *String*, *Boolean*, *String*) method on the `out` keyword. The first two parameters define the comment delimiters of the target language. The other parameters provide the name, enable-state and content of the protected region, as illustrated in Listing 7.10.

```
1 [%=out.preserve("/*", "*/", "anId", true,  
2     "System.out.println(foo);")  
3 %]
```

Listing 7.10: Protected region declaration using the `preserve` method.

A protected region declaration may have many lines, and use many EGL variables in the contents definition. To enhance readability, EGL provides two additional methods on the `out` keyword: *startPreserve*(*String*, *String*, *String*, *Boolean*) and *stopPreserve*. Listing 7.11 uses these to generate a protected region equivalent to that in Listing 7.10.

```
1 [%=out.startPreserve("/*", "*/", "anId", true)%]  
2 System.out.println(foo);  
3 [%=out.stopPreserve()%]
```

Listing 7.11: Protected region declaration.

Because an EGL template may contain many protected regions, EGL also provides a separate method to set the target language generated by the current template, `setContentTypes(String)`. By default, EGL recognises Java, HTML, Perl and EGL as valid content types. An alternative configuration file can be used to specify further content types. Following a call to `setContentTypes`, the first two arguments to the `preserve` and `startPreserve` methods can be omitted, as shown in Listing 7.12.

```
1 [% out.setContentTypes("Java"); %]  
2 [%=out.preserve("anId", true, "System.out.println(foo);")%]
```

Listing 7.12: Setting the content type.

Because some languages define more than one style of comment delimiter, EGL allows mixed use of the styles for `preserve` and `startPreserve` methods.

Once a content type has been specified, a protected region may also be declared entirely from a static section, using the syntax in Listing 7.13.

```
1 [% out.setContentTypes("Java"); %]  
2 // protected region anId [on/off] begin  
3 System.out.println(foo);  
4 // protected region anId end
```

Listing 7.13: Declaring a protected region from within a static section.

When a template that defines one or more protected regions is processed by the EGL execution engine, the target output destinations are examined and existing contents of any protected regions are preserved. If either the output generated by from the template or the existing contents of the target output destination contains protected regions, a merging process is invoked. Table 7.4 shows the default behaviour of EGL's merge engine.

## 7.6 Formatters

Often the text generated by a model-to-text transformation is not formatted in a desirable manner. Text generated with a model-to-text transformation might contain extra whitespace or inconsistent indentation. This is because controlling the formatting of generated text in a model-to-text transformation language can be challenging.

In a template-based model-to-text language, such as EGL, it can be difficult to know how best to format a transformation. On the one hand, the transformation must be readable and understandable, and on the other hand, the generated text must typically also be readable and understandable.

Protected Region Status		Contents taken from
Generated	Existing	
On	On	Existing
On	Off	Generated
On	Absent	Generated
Off	On	Existing
Off	Off	Generated
Off	Absent	Generated
Absent	On	Neither (causes a warning)
Absent	Off	Neither (causes a warning)

Table 7.4: EGL’s default merging behaviour.

Conscientious developers apply various *conventions* to produce readable code. EGL encourages template developers to prioritise the readability of templates over the readability of generated text when writing EGL templates. For formatting generated text, EGL provides an extensible set of *formatters* that can be invoked during a model-to-text transformation.

### 7.6.1 Using a Formatter

EGL provides several built-in formatters. Users can implement additional formatters (Section 7.6.2). To use a formatter, invoke the `setFormatter` or `setFormatters` operation on an instance of the *Template* type. A formatter is a Java class that implements EGL’s `Formatter` interface. From within an EGL program, formatters can be created using a Native (i.e. Java) type. Listing 7.14 demonstrates the use of a built-in formatter (`XmlFormatter`).

```

1 [%
2   var f = new Native("org.eclipse.epsilon.egl.formatter.language.XmlFormatter");
3   var t = TemplateFactory.load("generate_some_xml.egl");
4   t.setFormatter(f);
5   t.generate("formatted.xml");
6 %]
```

Listing 7.14: Using a formatter from within an EGL program.

To facilitate the re-use of a formatter with many templates, the *TemplateFactory* object provides the `setDefaultFormatter` and `setDefaultFormatters` operations. Templates that are loaded or prepared after a call to `setDefaultFormatter` or `setDefaultFormatters` will, by default, use the formatter(s) specified for the *TemplateFactory*.

Note that setting the formatter on a template overwrite any formatter that may have been set on that template by the *TemplateFactory*.

The default formatters for an EGL program can also be set when invoking the program. For example, the EGL development tools provide an Eclipse launch configuration that provides a tab named “Generated Text.” On this tab, users can configure one or more formatters which will be used as the default formatters for this EGL program. Note that custom formatters only appear on the launch configuration tab if they have been registered with EGL via an Eclipse extension. Similarly, the workflow language provided by Epsilon (Chapter 14) provides a `formatter` nested element that can be used to specify one or more default formatters.

## 7.6.2 Implementing a Custom Formatter

Providing a user-defined formatter involves implementing the `Formatter` interface (in `org.eclipse.epsilon.egl.formatter`). For example, Listing 7.15 demonstrates a simple formatter that transforms all generated text to uppercase.

```
1 import org.eclipse.epsilon.egl.formatter.Formatter;
2
3 public class UppercaseFormatter implements Formatter {
4
5     @Override
6     public String format(String text) {
7         return text.toUpperCase();
8     }
9 }
```

Listing 7.15: A simple custom formatter that transforms text to uppercase.

The set of built-in formatters provided by EGL includes some partial implementations of the `Formatter` interface that can be re-used to simplify the implementation of custom formatters. For instance, the `LanguageFormatter` class can correct the indentation of a program written in most languages, when given a start and end regular expression.

Finally, an Eclipse extension point is provided for custom formatters. Providing an extension that conforms to the custom formatter extension point allows EGL to display the custom formatter in the launch configuration tabs of the EGL development tools.



```

1  IEolExecutableModule module =
2      new EglTemplateFactoryModuleAdapter(new EglTemplateFactory());
3
4  boolean parsed = module.parse(new File("myTemplate.egl"));
5
6  if (parsed && module.getParseProblems().isEmpty()) {
7      module.execute();
8
9      Template base = module.getContext().getBaseTemplate();
10
11     // traverse the template hierachy
12     // display data
13
14 } else {
15     // error handling
16 }

```

Listing 7.16: Programmatically accessing the EGL traceability API (in Java).

## 7.7 Traceability

EGL also provides a traceability API, as a debugging aid, to support auditing of the M2T transformation process, and to facilitate change propagation. This API facilitates exploration of the templates executed, files affected and protected regions processed during a transformation. Figure 7.2 shows sample output from the traceability API after execution of an EGL M2T transformation to generate Java code from an instance of an OO meta-model. The view show in Figure 7.2 is accessed via the ... menu in Eclipse. Traceability information can also be accessed programmatically, as demonstrated in Listing 7.16.

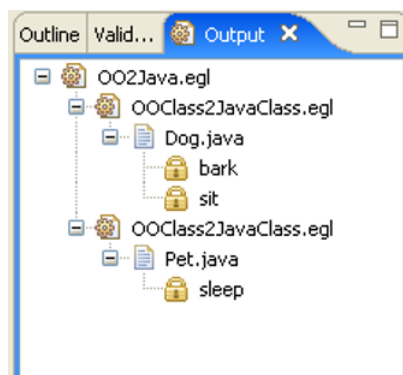

Figure 7.2: Sample output from the traceability API.



# Chapter 8

## The Epsilon Comparison Language (ECL)

Model comparison is the task of identifying *matching* elements between models. In general, *matching* elements are elements that are involved in a relationship of interest. For example, before merging homogeneous models, it is essential to identify overlapping (common) elements so that they do not appear in duplicate in the merged model. Similarly, in heterogeneous model merging, it is a prerequisite to identify the elements on which the two models will be merged. Finally, in transformation testing, matching elements are pairs consisting of elements in the input model and their generated counterparts in the output model.

The aim of the Epsilon Comparison Language (ECL) is to enable users to specify comparison algorithms in a rule-based manner to identify pairs of matching elements between two models of potentially different metamodels and modelling technologies. In this section, the abstract and concrete syntax, as well as the execution semantics of the language, are discussed in detail.

### 8.1 Abstract Syntax

In ECL, comparison specifications are organized in modules (*EcLModule*). As illustrated in Figure 8.1, *EcLModule* extends *EOLLibraryModule* which means that it can contain user-defined operations and import other library modules and ECL modules. Apart from operations, an ECL module contains a set of match-rules (*MatchRule*) and a set of *pre* and *post* blocks than run before and after all comparisons, respectively.

*MatchRules* enable users to perform comparison of model elements at a high level of abstraction. Each match-rule declares a name, and two parameters (*leftParameter* and

*rightParameter*) that specify the types of elements it can compare. It also optionally defines a number of rules it inherits (*extends*) and if it is *abstract*, *lazy* and/or *greedy*. The semantics of the latter are discussed shortly.

A match rule has three parts. The *guard* part is an EOL expression or statement block that further limits the applicability of the rule to an even narrower range of elements than that specified by the *left* and *right* parameters. The *compare* part is an EOL expression or statement block that is responsible for comparing a pair of elements and deciding if they match or not. Finally, the *do* part is an EOL expression or block that is executed if the *compare* part returns true to perform any additional actions required.

*Pre* and *post* blocks are named blocks of EOL statements which as discussed in the sequel are executed before and after the match-rules have been executed respectively.

## 8.2 Concrete Syntax

The concrete syntax of a match-rule is displayed in Listing 8.1.

```
1 (@lazy)?
2 (@greedy)?
3 (@abstract)?
4 rule <name>
5   match <leftParameterName>:<leftParameterType>
6   with <rightParameterName>:<rightParameterType>
7   (extends <ruleName>(, <ruleName>*)?)? {
8
9   (guard (:expression) | ({statementBlock}))?
10
11  compare (:expression) | ({statementBlock})
12
13  (do {statementBlock})?
14
15 }
```

Listing 8.1: Concrete Syntax of a MatchRule

*Pre* and *post* blocks have a simple syntax that, as presented in Listing 8.2, consists of the identifier (*pre* or *post*), an optional name and the set of statements to be executed enclosed in curly braces.

```
1 (pre | post) <name> {
2   statement+
3 }
```

Listing 8.2: Concrete Syntax of Pre and Post blocks

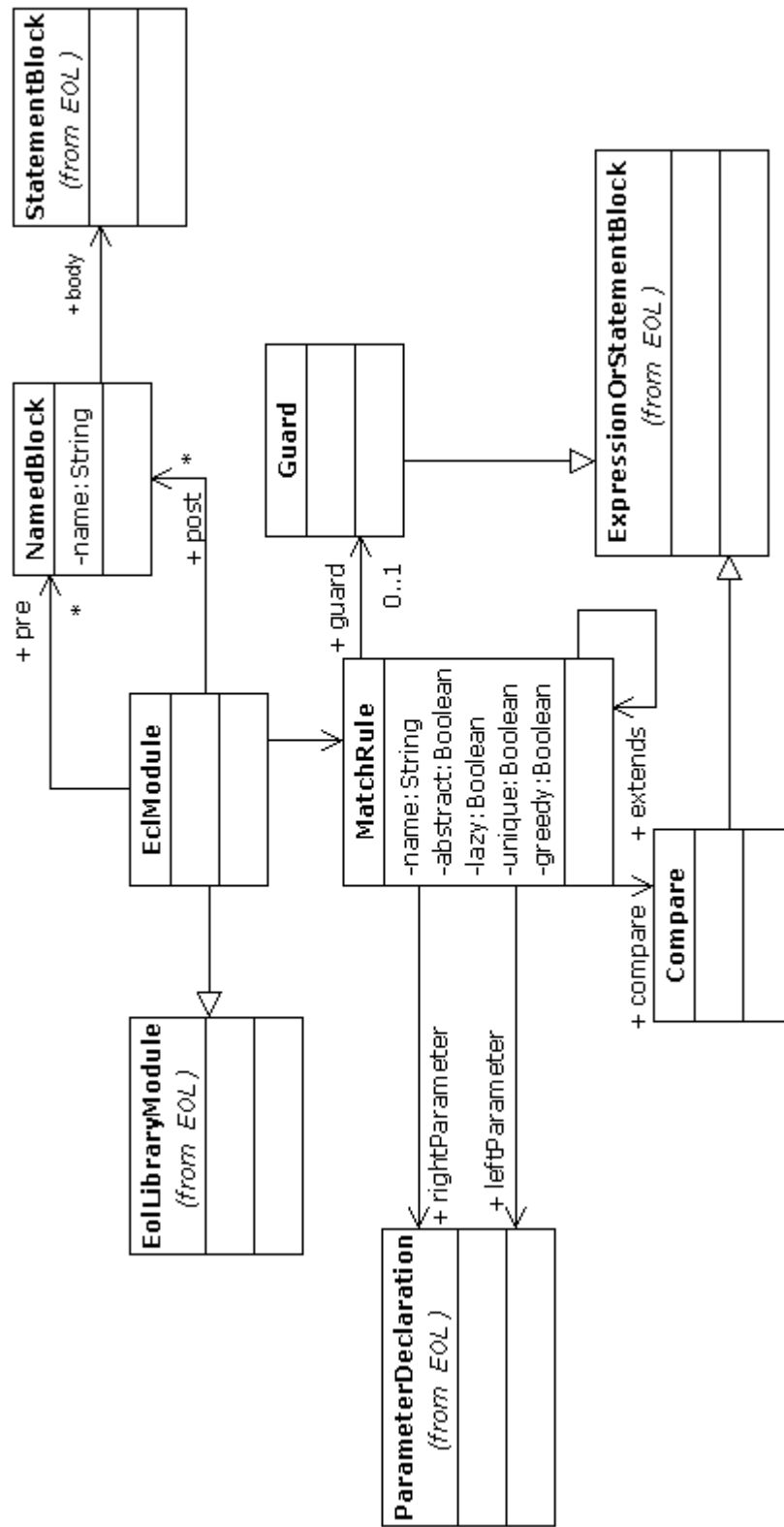

Figure 8.1: ECL Abstract Syntax

## 8.3 Execution Semantics

### 8.3.1 Rule and Block Overriding

An ECL module can import a number of other ECL modules. In such a case, the importing ECL module inherits all the rules and pre/post blocks specified in the modules it imports (recursively). If the module specifies a rule or a pre/post block with the same name, the local rule/block overrides the imported one respectively.

### 8.3.2 Comparison Outcome

As illustrated in Figure 8.2, the result of comparing two models with ECL is a trace (*Match-Trace*) that consists of a number of matches (*Match*). Each match holds a reference to the objects from the two models that have been compared (*left* and *right*), a boolean value that indicates if they have been found to be *matching* or not, a reference to the *rule* that has made the decision, and a Map (*info*) that is used to hold any additional information required by the user (accessible at runtime through the *matchInfo* implicit variable). During the matching process, a second, temporary, match trace is also used to detect and resolve cyclic invocation of match-rules as discussed in the sequel.

### 8.3.3 Rule Execution Scheduling

Non-abstract, non-lazy match-rules are evaluated automatically by the execution engine in a top-down fashion - with respect to their order of appearance - in two passes. In the first pass, each rule is evaluated for all the pairs of instances in the two models that have a type-of relationship with the types specified by the *leftParameter* and *rightParameter* of the rule. In the second pass, each rule that is marked as *greedy* is executed for all pairs that have not been compared in the first pass, and which have a kind-of relationship with the types specified by the rule. In both passes, to evaluate the compare part of the rule, the guard must be satisfied.

Before the compare part of a rule is executed, the compare parts of all of the rules it extends (super-rules) must be executed (recursively). Before executing the compare part of a super-rule, the engine verifies that the super-rule is actually applicable to the elements under comparison by checking for type conformance and evaluating the guard part of the super-rule.

If the compare part of a rule evaluates to true, the optional do part is executed. In the do part the user can specify any actions that need to be performed for the identified

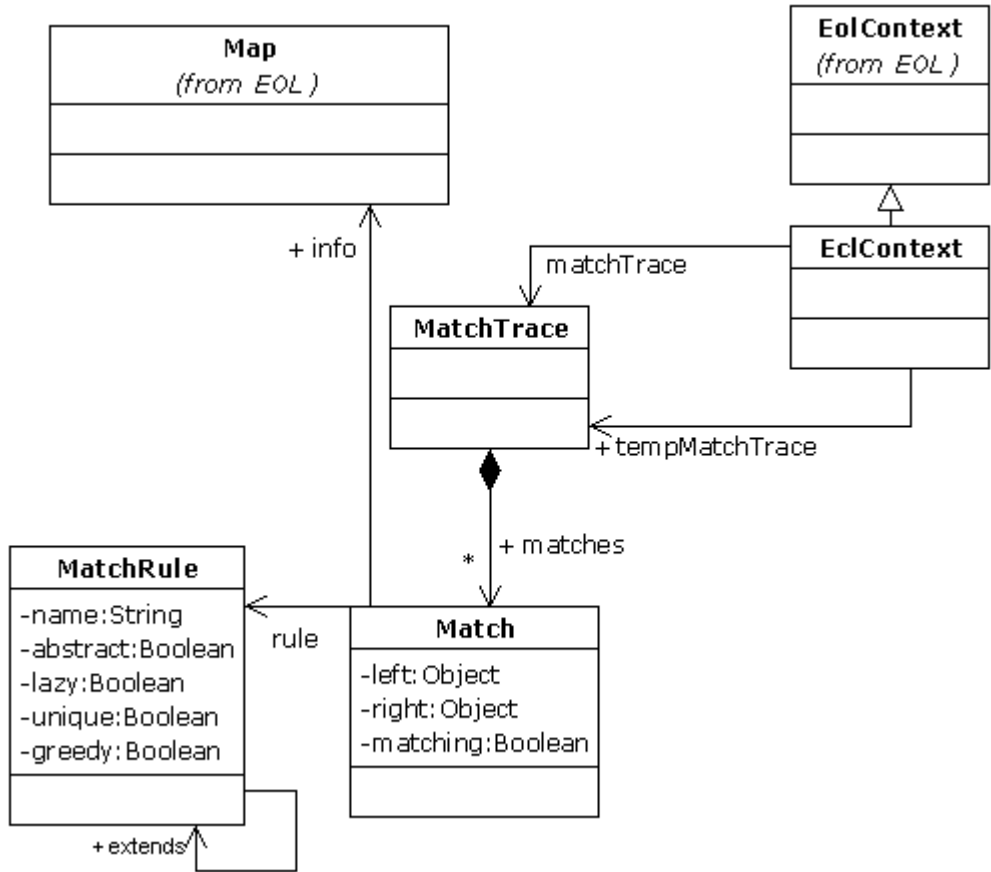

Figure 8.2: ECL Match Trace

matching elements, such as to populate the *info* map of the established *match* with additional information. Finally, a new match is added to the match trace that has its *matching* property set to the logical conjunction of the results of the evaluation of the compare parts of the rule and its super-rules.

### 8.3.4 The *matches()* built-in operation

To refrain from performing duplicate comparisons and to de-couple match-rules from each other, ECL provides the built-in *matches(opposite : Any)* operation for model elements and collections. When the *matches()* operation is invoked on a pair of objects, it queries the main and temporary match-traces to discover if the two elements have already been matched and if so it returns the cached result of the comparison. Otherwise, it attempts to find an appropriate match rule to compare the two elements and if such a rule is found, it returns the result of the comparison, otherwise it returns false. Unlike the top-level execution scheme, the *matches()* operation invokes both *lazy* and *non-lazy* rules.

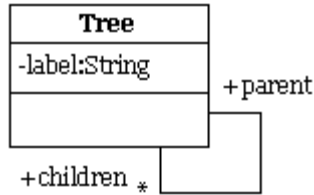

Figure 8.3: The Tree Metamodel

In addition to objects, the *matches* operations can also be invoked to match pairs of collections of the same type (e.g. a *Sequence* against a *Sequence*). When invoked on ordered collections (i.e. *Sequence* and *OrderedSet*), it examines if the collections have the same size and each item of the source collection matches with the item of the same index in the target collection. Finally, when invoked on unordered collections (i.e. *Bag* and *Set*), it examines if for each item in the source collection, there is a matching item in the target collection irrespective of its index. Users can also override the built-in *matches* operation using user-defined operations with the same name, as discussed in Section 3.4.2, that loosen or strengthen the built-in semantics.

### 8.3.5 Cyclic invocation of *matches()*

Providing the built-in *matches* operation significantly simplifies comparison specifications. It also enhances decoupling between match-rules from each other as when a rule needs to compare two elements that are outside its scope, it does not need to know/specify which other rule can compare those elements explicitly.

On the other hand, it is possible - and quite common indeed - for two rules to implicitly invoke each other. For example consider the match rule of Listing 8.3 that attempts to match nodes of the simple Tree metamodel displayed in Figure 8.3.

```

1 rule Tree2Tree
2   match l : T1!Tree
3   with r : T2!Tree {
4
5   compare : l.label = r.label and
6     l.parent.matches(r.parent) and
7     l.children.matches(r.children)
8 }

```

Listing 8.3: The Tree2Tree rule

The rule specifies that for two Tree nodes (*l* and *r*) to match, they should have the same label, belong to matching parents and have matching children. In the absence of



a dedicated mechanism for cycle detection and resolution, the rule would end up in an infinite loop. To address this problem, ECL provides a temporary match-trace which is used to detect and resolve cyclic invocations of the *match()* built-in operation.

As discussed above, a match is added to the primary match-trace as soon as the compare part of the rule has been executed to completion. By contrast, a temporary match (with its *matching* property set to *true*) is added to the temporary trace before the compare part is executed. In this way, any subsequent attempts to match the two elements from invoked rules will not re-invoke the rule. Finally, when a top-level rule returns, the temporary match trace is reset.

## 8.4 Fuzzy and Dictionary-based String Matching

In the example of Listing 8.3, the rule specifies that to match, two trees must - among other criteria - have the same label. However, there are cases when a less-strict approach to matching string properties of model elements is desired. For instance, when comparing two UML models originating from different organizations, it is common to encounter ontologically equivalent classes which however have different names (e.g. Client and Customer). In this case, to achieve a more sound matching, the use of a dictionary or a lexical database (e.g. WordNet [11]) is necessary. Alternatively, fuzzy string matching algorithms such as those presented in [12] can be used.

As several such tools and algorithms have been implemented in various programming languages, it is a sensible approach to reuse them instead of re-implementing them. For example, in Listing 8.4 a wrapper for the Simmetrics [13] fuzzy string comparison tool is used to compare the labels of the trees using the Levenshtein [14] algorithm. To achieve this, line 11 invokes the *fuzzyMatch()* operation defined in lines 16-18 which uses the simmetrics native tool (instantiated in lines 2-4) to match the two labels using their Levenshtein distance with a threshold of 0.5.

```
1 pre {
2   var simmetrics =
3     new Native("org.epsilon.ecl.tools.
4       textcomparison.simmetrics.SimMetricsTool");
5 }
6
7 rule FuzzyTree2Tree
8   match l : T1!Tree
9   with r : T2!Tree {
10
11   compare : l.label.fuzzyMatch(r.label) and
```

```

12     l.parent.matches(r.parent) and
13     l.children.matches(r.children)
14 }
15
16 operation String fuzzyMatch(other : String) : Boolean {
17     return simmetrics.similarity(self, other, "Levenshtein") > 0.5;
18 }

```

Listing 8.4: The FuzzyTree2Tree rule

## 8.5 Interactive Matching

Using the user interaction features discussed in Section 3.7 the comparison can become interactive by replacing the *fuzzyMatch* operation of listing 8.4 with the one specified in Listing 8.5. The *fuzzyMatch* operation of Listing 8.5, performs the fuzzy string comparison and – as the previous version – if the result is greater than 0.5 it returns true. However, in this updated version if the result is lower than 0.5 but greater than 0.3, it prompts the user to confirm if the two strings match, and if it is lower than 0.3 it returns false.

```

1 operation String fuzzyMatch(other : String) : Boolean {
2     var similarity : Real;
3     similarity = simmetrics.similarity(self, other, "Levenshtein");
4     if (similarity > 0.5) {
5         return true;
6     }
7     else if (similarity > 0.3) {
8         return UserInput.confirm(self + " matches " + other + "?");
9     }
10    else {
11        return false;
12    }
13 }

```

Listing 8.5: An interactive version of the *fuzzyMatch* operation of Listing 8.4

## 8.6 Exploiting the Comparison Outcome

Users can query and modify the match trace calculated during the comparison process in the post sections of the module or export it into another application or Epsilon program. For example, in a post section, the trace can be printed to the default output stream or serialized into a model of an arbitrary metamodel. In another use case, the trace may

be exported to be used in the context of a validation module that will use the identified matches to evaluate inter-model constraints, or in a merging module that will use the matches to identify the elements on which the two models will be merged. The topic of interoperability - that includes importing and exporting objects - between modules expressed in different Epsilon languages is discussed in Chapter 14.



# Chapter 9

## The Epsilon Merging Language (EML)

The aim of EML is to contribute model merging capabilities to Epsilon. More specifically, EML can be used to merge an arbitrary number of input models of potentially diverse metamodels and modelling technologies. This section provides a discussion on the motivation for implementing EML, its abstract and concrete syntax, as well as its execution semantics. It also provides two examples of merging homogeneous and heterogeneous models.

### 9.1 Motivation

A mechanism that enables automatically merging models on a set of established correspondences has a number of applications in a model driven engineering process. For instance, it can be used to unify two complementary, but potentially overlapping, models that describe different views of the same system. In another scenario, it can be used to merge a core model with an aspect model (potentially conforming to different metamodels), as discussed in [15] where a core *Platform Independent Model (PIM)* is merged with a *Platform Definition Model (PDM)*, that contributes platform-specific aspects, into a *Platform Specific Model (PSM)*.

#### 9.1.1 Phases of Model Merging

Existing research [16, 17] has demonstrated that model merging can be decomposed into four distinct phases: comparison, conformance checking, merging and reconciliation (or restructuring).

**Comparison Phase** In the comparison phase, correspondences between equivalent elements of the source models are identified, so that such elements are not propagated in duplicate in the merged model.

**Conformance Checking Phase** In this phase, elements that have been identified as matching in the previous phase are examined for conformance with each other. The purpose of this phase is to identify potential conflicts that would render merging infeasible. The majority of proposed approaches, such as [18], address conformance checking of models complying with the same metamodel.

**Merging Phase** Several approaches have been proposed for the merging phase. In [16, 19], graph-based algorithms for merging models of the same metamodel are proposed. In [18], an interactive process for merging of UML 2.0 models is presented. There are at least two weaknesses in the methods proposed so far. First, they only address the issue of merging models of the same metamodel, and some of them address a specific metamodel indeed. Second, they use an inflexible merging algorithm and do not provide means for extending or customizing its logic.

**Reconciliation and Restructuring Phase** After the merging phase, the target model may contain inconsistencies that need fixing. In the final step of the process, such inconsistencies are removed and the model is *polished* to acquire its final form. Although the need for a reconciliation phase is discussed in [17, 19], in the related literature the subject is not explicitly targeted.

### 9.1.2 Relationship between Model Merging and Model Transformation

A merging operation is a transformation in a general sense, since it transforms some input (source models) into some output (target models). However, as discussed throughout this section, a model merging facility has special requirements (support for comparison, conformance checking and merging pairs of input elements) that are not required for typical *one-to-one* or *one-to-many* transformations [8] and are therefore not supported by contemporary model transformation languages.

## 9.2 Realizing a Model Merging Process with Epsilon

The first two steps of the process described above can be realized with existing languages provided by Epsilon. As discussed in Section 8, the comparison step can be realized with the Epsilon Comparison Language (ECL). Following that, the Epsilon Validation Language (EVL) can be used to validate the identified correspondences using the match trace calculated by ECL. The Epsilon Merging Language (EML) presented below provides support for the last two steps of the process (merging and reconciliation/restructuring).

## 9.3 Abstract Syntax

In EML, merging specifications are organized in modules (*EmlModule*). As displayed in Figure 9.1, *EmlModule* inherits from *EtlModule*.

By extending *EtlModule*, an EML module can contain a number of transformation rules and user-defined operations. An EML module can also contain one or more merge rules as well as a set of *pre* and *post* named EOL statement blocks. As usual, *pre* and *post* blocks will be run before and after all rules, respectively.

Each merge rule defines a name, a left, a right, and one or more target parameters. It can also extend one or more other merge rules and be defined as having one or more of the following properties: abstract, greedy, lazy and primary.

## 9.4 Concrete Syntax

Listing 9.1 demonstrates the concrete syntax of EML merge-rules.

```
1 (@abstract)?
2 (@lazy)?
3 (@primary)?
4 (@greedy)?
5 rule <name>
6   merge <leftParameter>
7   with <rightParameter>
8   into (<targetParameter>(, <targetParameter>)*)?
9   (extends <ruleName>(, <ruleName>)*)? {
10
11   statementBlock
12
13 }
```

Listing 9.1: Concrete syntax of an EML merge-rule

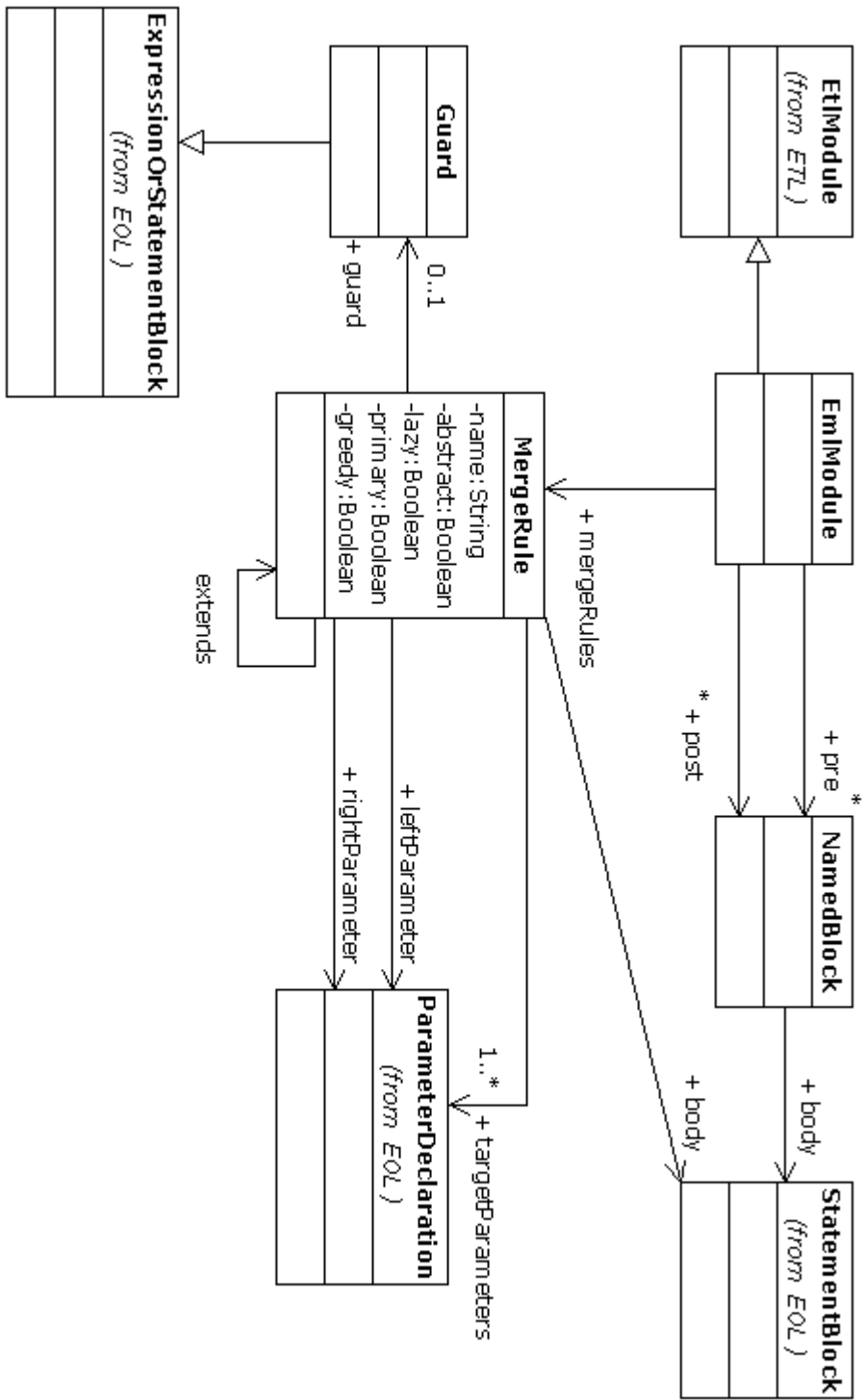

Figure 9.1: The Abstract Syntax of EML



*Pre* and *post* blocks have a simple syntax that, as presented in Listing 9.2, consists of the identifier (*pre* or *post*), an optional name and the set of statements to be executed enclosed in curly braces.

```
1 (pre|post) <name> {  
2   statement+  
3 }
```

Listing 9.2: Concrete Syntax of Pre and Post blocks

## 9.5 Execution Semantics

### 9.5.1 Rule and Block Overriding

An EML module can import a number of other EML and ETL modules. In this case, the importing EML module inherits all the rules and pre/post blocks specified in the modules it imports (recursively). If the module specifies a rule or a pre/post block with the same name, the local rule/block overrides the imported one respectively.

### 9.5.2 Rule Scheduling

When an EML module is executed, the *pre* blocks are executed in the order in which they have been defined.

Following that, for each *match* of the established *matchTrace* the applicable non-abstract, non-lazy merge rules are executed. When all *matches* have been merged, the transformation rules of the module are executed on all applicable elements - that have not been merged - in the models.

Finally, after all rules have been applied, the *post* blocks of the module are executed.

### 9.5.3 Rule Applicability

By default, for a merge-rule to apply to a *match*, the *left* and *right* elements of the match must have a *type-of* relationship with the *leftParameter* and *rightParameter* of the rule respectively. This can be relaxed to a *kind-of* relationship by specifying that the merge rule is *greedy* (using the *@greedy* annotation in terms of concrete syntax).

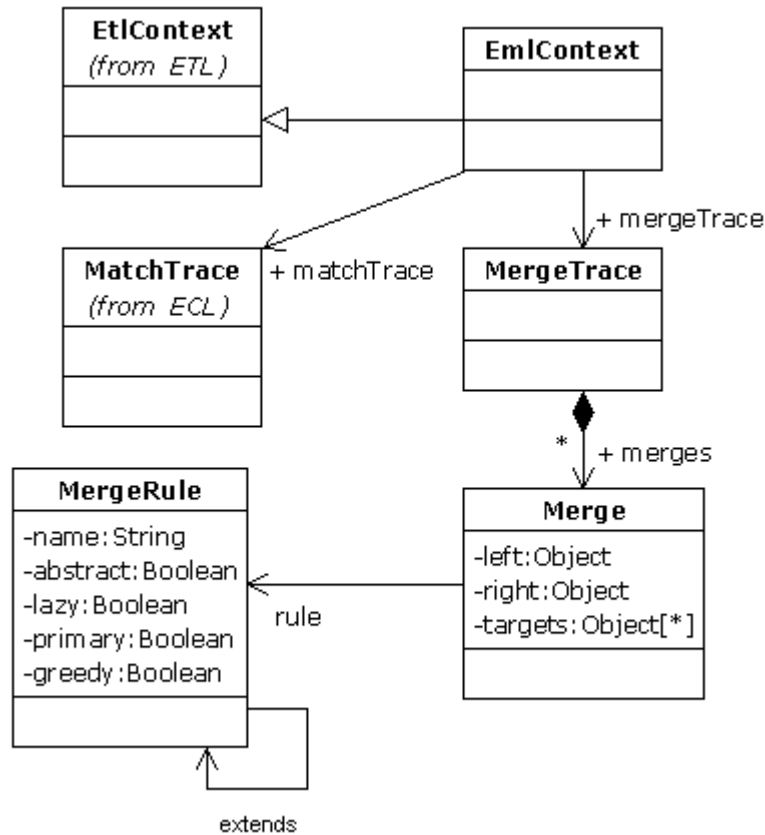

Figure 9.2: The EML runtime

### 9.5.4 Source Elements Resolution

As with model transformation, in model merging it is often required to resolve the counterparts of an element of a source model into the target models. In EML, this is achieved by overloading the semantics of the *equivalents()* and *equivalent()* operations defined by ETL. In EML, in addition to inspecting the transformation trace and invoking any applicable transformation rules, the *equivalents()* operation also examines the *mergeTrace* (displayed in Figure 9.2) that stores the results of the application of merge-rules and invokes any applicable (both lazy and non-lazy) rules.

Similarly to ETL, the order of the results of the *equivalents()* operation respects the order of the (merge or transform) rules that have produced them. An exception to that occurs if one of the rules has been declared as primary, in which case its results are prepended to the list of elements returned by *equivalent*.

## 9.6 Homogeneous Model Merging Example

In this scenario, two models conforming to the Graph metamodel need to be merged. The first step is to compare the two graphs using the ECL module of Listing 9.3.

```
1 rule MatchNodes
2   match l : Left!Node
3   with r : Right!Node {
4
5     compare : l.label = r.label
6   }
7
8 rule MatchEdges
9   match l : Left!Edge
10  with r : Right!Edge {
11
12    compare : l.source.matches(r.source)
13             and l.target.matches(r.target)
14  }
15
16 rule MatchGraphs
17   match l : Left!Graph
18   with r : Right!Graph {
19
20     compare : true
21  }
```

Listing 9.3: ECL module for comparing two instances of the Graph metamodel

The *MatchNodes* rule in line 1 defines that two nodes match if they have the same label. The *MatchEdges* rule in line 8 specifies that two edges match if both their source and target nodes match (regardless of whether the labels of the edges match or not as it is assumed that there can not be two distinct edges between the same nodes). Finally, since only one instance of Graph is expected to be in each model, the *MatchGraphs* rule in line 16 returns *true* for any pair of Graphs<sup>1</sup>.

Having established the necessary correspondences between matching elements of the two models, the EML specification of listing 9.4 performs the merge.

```
1 import "Graphs.etl";
2
3 rule MergeGraphs
4   merge l : Left!Graph
```

---

<sup>1</sup>Both assumptions can be checked using EVL before matching/merging takes place but this is out of the scope of this example

```

5  with r : Right!Graph
6  into t : Target!Graph {
7
8  t.label = l.label + " and " + r.label;
9
10 }
11
12 @abstract
13 rule MergeGraphElements
14   merge l : Left!GraphElement
15   with r : Right!GraphElement
16   into t : Target!GraphElement {
17
18   t.graph ::= l.graph;
19
20 }
21
22 rule MergeNodes
23   merge l : Left!Node
24   with r : Right!Node
25   into t : Target!Node
26   extends GraphElements {
27
28   t.label = "c_" + l.label;
29
30 }
31 rule MergeEdges
32   merge l : Left!Edge
33   with r : Right!Edge
34   into t : Target!Edge
35   extends GraphElements {
36
37   t.source ::= l.source;
38   t.target ::= l.target;
39
40 }

```

Listing 9.4: EML module for merging two instances of the Graph metamodel on the correspondences identified in Listing 9.3

In line 3, the *MergeGraphs* merge rule specifies that two matching Graphs (*l* and *r*) are to be merged into one Graph *t* in the target model that has as a label, the concatenation of the labels of the two input graphs separated using 'and'. The *mergeNodes* rule In line 22 specifies that two matching Nodes are merged into a single Node in the target model. The

label of the merged node is derived by concatenating the *c* (for common) static string with the label of the source Node from the left model. Similarly, the *MergeEdges* rule specifies that two matching Edges are merged into a single Edge in the target model. The source and target nodes of the merged Edge are set to the equivalents ( $::=$ ) of the source and target nodes of the edge from the left model.

To reduce duplication, the *MergeNodes* and *MergeEdges* rules extend the abstract *MergeGraphElements* rule specified in line 13 which assigns the *graph* property of the graph element to the equivalent of the left graph.

The rules displayed in Listing 9.4 address only the matching elements of the two models. To also copy the elements for which no equivalent has been found in the opposite model, the EML module imports the ETL module of Listing 9.5.

```
1 rule TransformGraph
2   transform s : Source!Graph
3   to t : Target!Graph {
4
5     t.label = s.label;
6
7   }
8
9 @abstract
10 rule TransformGraphElement
11   transform s : Source!GraphElement
12   to t : Target!GraphElement {
13
14     t.graph ::= s.graph;
15   }
16
17 rule TransformNode
18   transform s : Source!Node
19   to t : Target!Node
20   extends TransformGraphElement {
21
22     t.label = s.graph.label + "_" + s.label;
23   }
24
25 rule TransformEdge
26   transform s : Source!Edge
27   to t : Target!Edge
28   extends TransformGraphElement {
29
30     t.source ::= s.source;
```

```
31 t.target ::= s.target;  
32 }
```

Listing 9.5: The Graphs.etl ETL transformation module

The rules of the ETL module apply to model elements of both the Left and the Right model as both have been aliased as Source. Of special interest is the TransformNode rule in line 17 that specifies that non-matching nodes in the two input models will be transformed into nodes in the target model the labels of which will be a concatenation of their input graph and the label of their counterparts in the input models.

Executing the ECL and EML modules of Listings 9.3 and 9.4 on the exemplar models displayed in Figures 9.3 and 9.4 creates the target model of Figure 9.5.

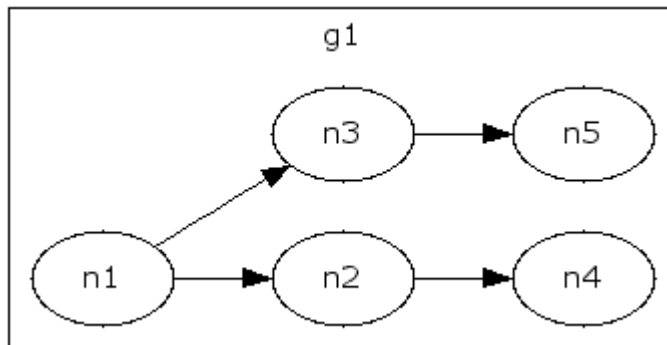

Figure 9.3: Left input model

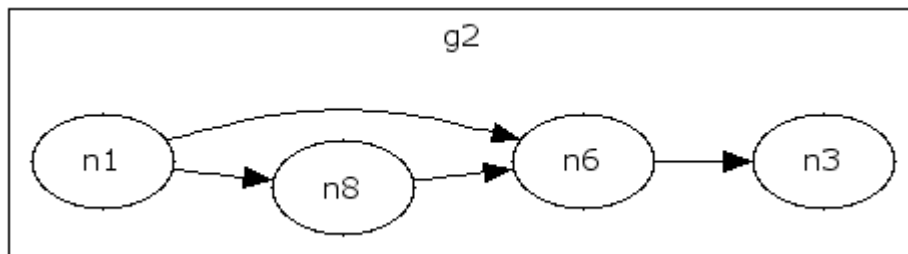

Figure 9.4: Right input model

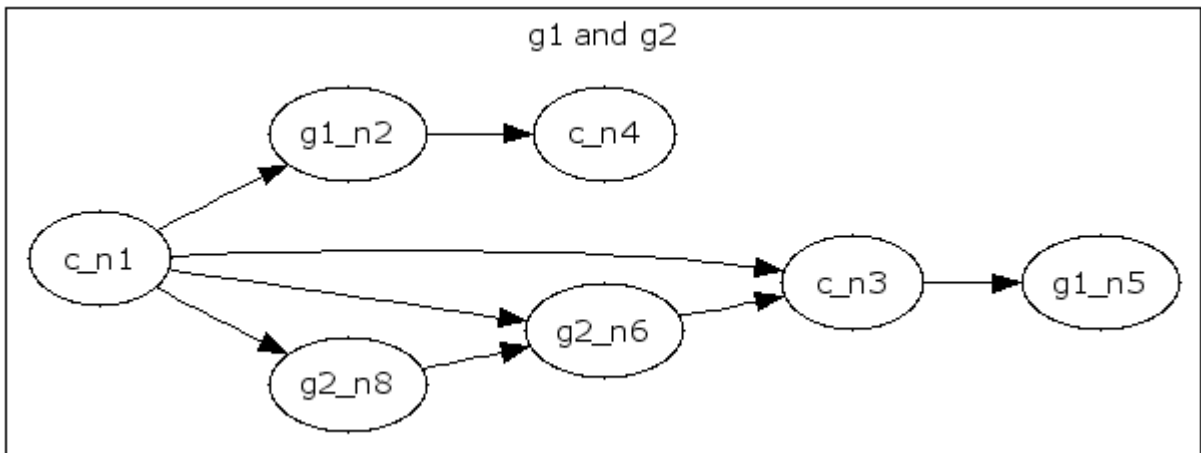

Figure 9.5: Target model derived by merging the models of Figures 9.3 and 9.4





# Chapter 10

## Epsilon Flock for Model Migration

The aim of Epsilon Flock is to contribute *model migration* capabilities to Epsilon. Model migration is the process of updating models in response to metamodel changes. This section discusses the motivation for implementing Flock, introduces its syntax and execution semantics, and demonstrates the use of Flock with an example. Flock can be used to update models to a new version of their metamodel, or even to move from one modelling technology to another (e.g., from XML to EMF).

### 10.1 Background and Motivation

Model migration involves updating a model in response to changes to the metamodel. Typically, metamodel evolution is accomplished incrementally: changes are made to part of the metamodel and hence model migration typically involves updating only a small proportion of a model's elements [20, 21]. Effectively then, model migration is a model-to-model transformation in which the source and target metamodels are similar but not the same. However, as discussed below, model-to-model transformation languages are often cumbersome for specifying model migration.

To illustrate the challenges of model migration, we use the example of metamodel evolution in Figure 10.1. In Figure 10.1(a), a `Component` comprises other `Components`, `Connectors` and `Ports`. A `Connector` joins two `Ports`. `Connectors` are unidirectional, and hence define `to` and `from` references to `Port`. The original metamodel allows a `Connector` to start and end at the same `Port`, and the metamodel was evolved to prevent this, as shown in Figure 10.1(b). `Port` was made abstract, and split into two subtypes, `InputPort` and `OutputPort`. The references between `Connector` and (the subtypes of) `Port` were renamed for consistency with the names of the subtypes.

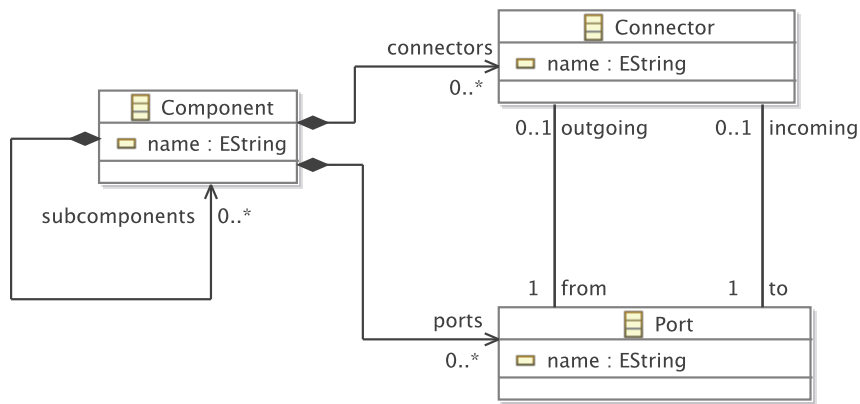

(a) Original metamodel.

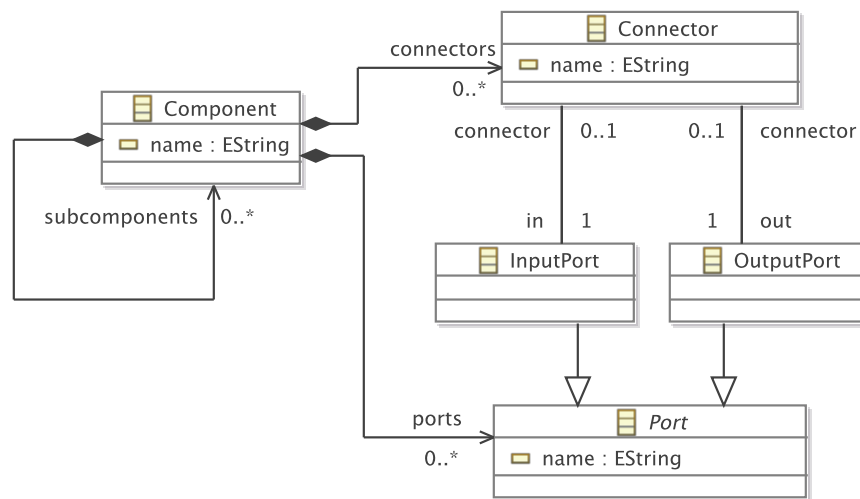

(b) Evolved metamodel.

Figure 10.1: Process-oriented metamodel evolution.

Some models that conform to the original metamodel do not conform to the evolved metamodel. Specifically, models might not conform to the evolved metamodel because:

1. They contain instances of `Port`, which is an abstract class in the evolved metamodel.
2. They contain instances of `Connector` that specify values for the features `to` and `from`, which are not defined for the `Connector` type in the evolved metamodel.
3. They contain instances of `Connector` that do not specify a value for the `in` and `out` features, which are mandatory for the `Connector` type in the evolved metamodel.

Model migration can be achieved with a general-purpose model-to-model transformation using a language such as ETL (Chapter 5). However, this typically involves writing a large amount of repetitive and redundant code [22]. Flock reduces the amount of repetitive and redundant code needed to specify model migration by automatically copying from the original to the migrated model all of the model elements that conform to the evolved metamodel as described below.

## 10.2 Abstract Syntax

As illustrated by Figure 10.2, Flock migration strategies are organised into individual modules (`FlockModule`). Flock modules inherit from EOL language constructs for specifying user-defined operations and for importing other (EOL and Flock) modules. Like the other rule-based of Epsilon, Flock modules may comprise any number of pre (post) blocks, which are executed before (after) all other constructs. Flock modules comprise any number of type mappings (`TypeMapping`) and rules (`Rule`). Type mappings operate on metamodel types (`Retying` and `Deletion`) or on metamodel packages (`PackageRetying` and `PackageDeletion`). Type mappings are applied to a type in the original metamodel (`originalType`) or to a package in the original metamodel (`originalPackage`). Additionally, `Retyings` apply to an evolved metamodel type (`evolvedType`) or package (`evolvedPackage`). Each rule has an original metamodel type (`originalType`), a body comprising a block of EOL statements, and zero or more `ignoredFeatures`. Type mappings and rules can optionally specify a `guard`, which is either an EOL statement or a block of EOL statements. Type mappings that operate on metamodel types and rules can be marked as `strict`.

## 10.3 Concrete Syntax

Listing 10.1 demonstrates the concrete syntax of the Flock language constructs. All of the constructs begin with keyword(s) (`retype`, `retype package delete`, `delete package` or `migrate`), followed by the original metamodel type or package. Additionally, type mappings that operate on metamodel types and rules can be annotated with the `strict` modifier. The `delete` construct can be annotated with a `cascade` modifier. All constructs can have guards, which are specified using the `when` keyword.

Migrate rules can specify a list of features that conservative copy will ignore (`ignoring`), and a `body` containing a sequence of at least one EOL statement. Note that a migrate rule must have a list of ignored features, or a `body`, or both.

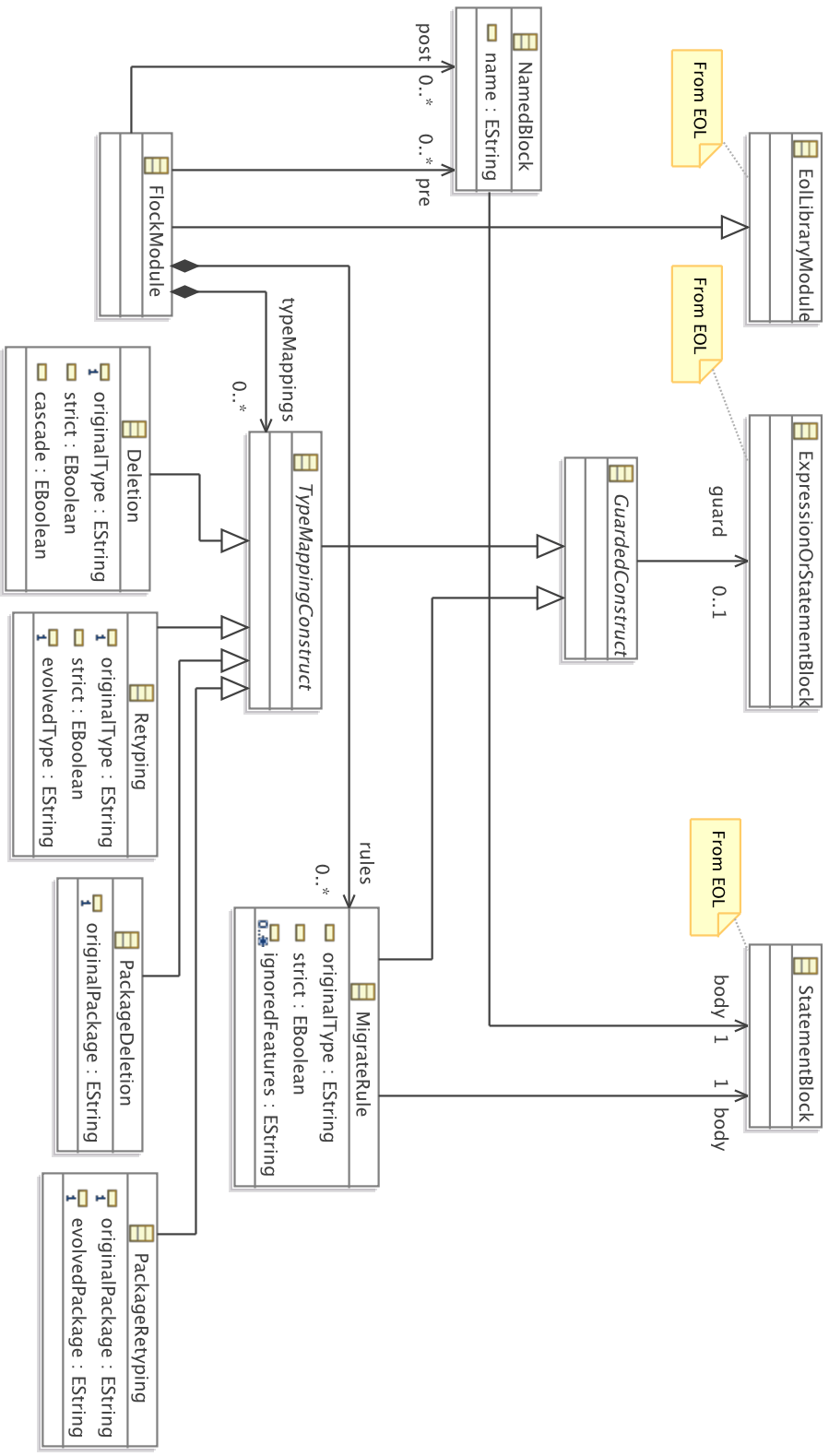

Figure 10.2: The Abstract Syntax of Flock

```

1 (@strict)?
2 retype <originalType> to <evolvedType>
3 (when (:<eolExpression>) | ({<eolStatement>+}))?
4
5 retype package <originalPackage> to <evolvedPackage>
6 (when (:<eolExpression>) | ({<eolStatement>+}))?
7
8 (@strict)?
9 (@cascade)?
10 delete <originalType>
11 (when (:<eolExpression>) | ({<eolStatement>+}))?
12
13 delete package <originalPackage>
14 (when (:<eolExpression>) | ({<eolStatement>+}))?
15
16 (@strict)?
17 migrate <originalType>
18 (ignoring <featureList>)?
19 (when (:<eolExpression>) | ({<eolStatement>+}))? {
20   <eolStatement>+
21 }

```

Listing 10.1: Concrete syntax of Flock retypings, deletions and migrate rules

*Pre* and *post* blocks have a simple syntax that, as presented in Listing 10.2, consists of the identifier (*pre* or *post*), an optional name and the set of statements to be executed enclosed in curly braces.

```

1 (pre|post) <name> {
2   statement+
3 }

```

Listing 10.2: Concrete Syntax of Pre and Post blocks

## 10.4 Execution Semantics

The execution semantics of a Flock module are now described. Note that the Epsilon Model Connectivity (EMC) layer (Chapter 2), which Flock uses to access and manipulate models supports a range of modelling technologies, and identifies types by name. Consequently, the term *type* is used to mean “the name of an element of a metamodel” in the following discussion. For example, *Component*, *Connector* and *InputPort* are three of the types defined in Figure 10.1(b).

Execution of a Flock module occurs in six phases:

1. Any pre blocks are executed.
2. Type mapping constructs (retypings and deletions) are processed to identify the way in which original and evolved metamodel types are to be related.
3. Migrate rules are inspected to build sets of ignored properties.
4. The information determined in steps 2 and 3 is used as input a copying algorithm, which creates an (equivalent) element in the migrated model for each element of the original model, and copies values from original to equivalent model elements.
5. Migrate rules are executed on each pair of original and (equivalent) migrated model elements.
6. Any post blocks are executed.

In phases 2-5, language constructs are executed only when they are *applicable*. The *applicability* of the Flock language constructs (retyping, deletion or migrate rule) is determined from their type and guard. For a language construct  $c$  to be applicable to an original model element  $o$ ,  $o$  must instantiate either the original type of  $c$  or one of the subtypes of the original type of  $c$ ; and  $o$  must satisfy the guard of  $c$ . For language constructs that have been annotated as strict, type-checking is more restrictive:  $o$  must instantiate the original type of  $c$  (and not one its subtypes). In other words, the applicability of strict constructs is determined with EOL's `isTypeOf` operation and the applicability of non-strict constructs is determined with EOL's `isKindOf` operation (Table 3.1). For language constructs that have been annotated with cascade, type-checking is less restrictive:  $o$  must be contained in another model element (either directly or indirectly) to which the construct is applicable. Similarly, for language constructs that operate on packages (i.e. package retyping and package deletions), type-checking is less restrictive:  $o$  must be contained in a package with the same name as the original package of  $c$ .

Phases 2-4 of execution implement a copying algorithm which has been termed conservative copy and is discussed thoroughly elsewhere [22]. Essentially, conservative copy will do the following for each element of the original model,  $o$ :

1. **Do nothing** when  $o$  instantiates a type that cannot be instantiated in the evolved metamodel (e.g., because the type of  $o$  is now abstract or no longer exists). Example: instances of `Port` in Figure 10.1 are not copied because `Port` has become abstract.
2. **Fully copy**  $o$  to produce  $m$  in the migrated model when  $o$  instantiate a type that has not been at all affected by metamodel evolution. Example: instances of `Component`

in Figure 10.1 are fully copied because neither `Component` nor any of its features have been changed.

3. **Partially copy**  $o$  to produce  $m$  in the migrated model when  $o$  instantiates a type with one or more features that have been affected by metamodel evolution. Example: instances of `Connector` in Figure 10.1 are partially copied because the `from` and `to` features have been renamed. Note that in a partial copy only the features that have not been affected by metamodel evolution are copied (e.g., the names of `Connectors`).

In phase 5, migrate rules are applied. These rules specify the problem-specific migration logic and might, for example, create migrated model elements for original model elements that were skipped or partially copied by the copying algorithm described above. The Flock engine makes available two variables (`original` and `migrated`) for use in the body of any migration rule. These variables are used to refer to the particular elements of the original and migrated models to which the rule is currently being applied. In addition, Flock defines an `equivalent()` operation that can be called on any original model element and returns the equivalent migrated model element (or `null`). The `equivalent()` operation is used to access elements of the migrated model that cannot be accessed via the `migrated` variable due to metamodel evolution. Flock rules often contain statements of the form: `original.x.equivalent()` where `x` is a feature that has been removed from the evolved metamodel.

Finally, we should consider the order in which Flock schedules language constructs: a construct that appears earlier (higher) in the source file has priority. This is important because only one type mapping (retypings and deletions) is applied per original model element, and because this implies that migrate rules are applied from top-to-bottom. This ordering is consistent with the other languages of the Epsilon platform.

## 10.5 Example

Flock is now demonstrated using the example of model migration introduced in Section 10.1. Recall that the metamodel evolution in Figure 10.1 involves splitting the `Port` type to form the `InputPort` and `OutputPort` types. Figure 10.3 provides a high-level design for migrating models from the original to the evolved metamodel in Figure 10.1.

The Flock migration strategy that implements this design is shown<sup>1</sup> in Listing 10.3.

---

<sup>1</sup>Note that `in` and `to` are reserved words in EOL, and hence backticks are used to refer to the metamodel features `in` and `to` on lines 7, 8 and 16 of Listing 10.3.

- For every instance, *p*, of `Port` in the original model:
  - If there exists in the original model a `Connector`, *c*, that specifies *p* as the value for its `from` feature:
    - Create a new instance, *i*, of `InputPort` in the migrated model.
    - Set *c* as the `connector` of *i*.
    - Add *c* to the `ports` reference of the `Component` that contains *c*.
  - If there exists in the original model a `Connector`, *c*, that specifies *p* as the value for its `to` feature:
    - Create a new instance of `OutputPort` in the migrated model.
    - Set *c* as the `connector` of *i*.
    - Add *c* to the `ports` reference of the `Component` that contains *c*.
- And nothing else changes.

Figure 10.3: Model migration strategy in pseudo code for the metamodel evolution in Figure 10.1.

```

1 delete Port when: not (original.isInput() xor original.isOutput())
2
3 retype Port to InputPort when: original.isInput()
4 retype Port to OutputPort when: original.isOutput()
5
6 migrate Connector {
7   migrated.`in` = original.from.equivalent();
8   migrated.out = original.`to`.equivalent();
9 }
10
11 operation Original!Port isInput() : Boolean {
12   return Original!Connector.all.exists(c|c.from == self);
13 }
14
15 operation Original!Port isOutput() : Boolean {
16   return Original!Connector.all.exists(c|c.`to` == self);
17 }

```

Listing 10.3: Flock migration strategy for the process-oriented metamodel evolution in Figure 10.1

Three type mappings constructs (on lines 1-4) are used to control the way in which instances of `Port` are migrated. For example, line 3 specifies that instances of `Port` that are referenced via the `from` feature of a `Connector` are retyped, becoming `InputPorts`. Instances of `Connector` are migrated using the rule on lines 6-9, which specifies the way in which the `from` and `to` features have evolved to form the `in` and `out` features.

Note that metamodel elements that have not been affected by the metamodel evolu-



tion, such as `Components`, are migrated automatically. Explicit copying code would be needed to achieve this with a general purpose model-to-model transformation language.

## 10.6 Limitations and Scope

Although Flock has been shown to much more concise than general purpose model-to-model transformation languages for specifying model migration, Flock does not provide some of the features commonly available in general-purpose model-to-model transformation language. This section discusses the limitations of Flock and its intended scope with respect to other tools for model migration.

### 10.6.1 Limitations

Firstly, Flock does not support rule inheritance, and re-use of migration logic is instead achieved by exploiting the inheritance hierarchy of the original metamodel. The form of re-use provided by Flock is less general than rule-inheritance, but has proved sufficient for existing use-cases.

Secondly, Flock does not provide language constructs for controlling the order in which rules are scheduled (other than the ordering of the rules in the program file). ATL, for example, includes constructs that allow users to specify that rules are scheduled explicitly (lazy rules) or in a memoised manner (unique rules). We anticipate that scheduling constructs might be necessary for larger migration strategies, but have not yet encountered situations in which they have been required.

Thirdly, Flock is tailored for applying migration to a single original and a single migrated model. Although further models can be accessed by a Flock migration strategy, they cannot be used as the source or target of the conservative copy algorithm. By contrast, some general-purpose model transformation languages can access and manipulate any number of models.

Finally, Flock has been tailored to the model migration problem. In other words, we believe that Flock is well-suited to specifying model transformations between two metamodels that are very similar. For metamodel evolution in which the original metamodel undergoes significant and large-scale revision, a general-purpose transformation might be more suitable than Flock for specifying model migration.

## 10.6.2 Scope

Flock is typically used as a manual specification approach in which model migration strategies are written by hand. As such, we believe that Flock provides a flexible and concise way to specify migration, and is a foundation for further tools that seek to automate the metamodel evolution and model migration processes. There are approaches to model migration that encompass both the metamodel evolution and model migration processes, seeking to automatically derive model migration strategies (e.g., Edapt <http://www.eclipse.org/edapt/>). These approaches provide more automation but at the cost of flexibility: for example, you might be restricted to using a tool-specific editor to perform model migration, or to using only EMF.

## 10.7 Further Reading

Further examples of applying Flock include migration of UML activity diagrams (at Transformation Tool Contest 2010 workshop<sup>2</sup>), and migration of UML class diagrams, GMF models, and a domain-specific modelling language for NNTP newsgroups in Rose's doctoral thesis [23].

A more thorough discussion of the design decisions and execution semantics of Flock can be found in a SoSyM journal article [22]. Flock has been compared with other model migration tools and languages in a MoDELS paper [24].

---

<sup>2</sup><http://planet-mde.org/ttc2010/>

# Chapter 11

## The Epsilon Pattern Language (EPL)

### 11.1 Background and Motivation

Several solutions have been proposed for the problem of pattern matching in models conforming to metamodels specified using standardised metamodeling languages. The majority of these solutions take the form of tailored graphical or textual languages, through which patterns can be specified at a certain level of abstraction, and accompanying interpreters/compiler which can then match these pattern specifications against concrete models. Examples of graphical pattern matching languages include AGG [25] and EMF Tiger [26], while examples of textual languages include GrGen.NET [27], VIATRA2 [28] and EMF-IncQuery [29]. In [30], QVTr has also been used to express and detect patterns in EMF models.

Pattern matching is often only one step in a chain of model management operations. As such, languages for pattern matching should ideally integrate seamlessly with languages that support other model management tasks such as model validation, comparison, transformation etc. In our review of previous work, we have identified that existing languages for pattern matching are typically bundled together with in-place and/or model-to-model transformation capabilities, and can only be integrated with languages that support other MDE tasks such as model validation and model-to-text transformation either through serialising detected patterns in a commonly supported format or through developing bespoke inter-tool adapters. Even in cases where interoperability with other model management languages is feasible, developing pattern specifications and other model management programs in different and inconsistent syntaxes can introduce code duplication and, consequently, hinder development and maintenance [31]. Another limitation of existing pattern matching languages is that they typically target a specific modelling technology (e.g. EMF) and/or model representation format, which renders specifying and detecting patterns that

involve elements of heterogeneous models (e.g. an EMF model and an XML document) particularly challenging, if possible at all.

The above limitations have motivated us to design and implement a new pattern matching language, the Epsilon Pattern Language (EPL), which enables seamless runtime interoperability and code reuse with languages supporting a range of model management tasks, and also provides support for specifying patterns that involve elements of models conforming to different modelling technologies.

This chapter discusses the abstract and concrete syntax of EPL as well as its execution semantics. To aid understanding, the discussion of the syntax and the semantics of the language revolves around an exemplar pattern which is developed incrementally throughout the chapter. The exemplar pattern is matched against models extracted from Java source code using tooling provided by the MoDisco<sup>1</sup> project. MoDisco is an Eclipse project that provides a fine-grained Ecore-based metamodel of the Java language as well as tooling for extracting models that conform to this Java metamodel from Java source code. A simplified view of the relevant part of the MoDisco Java metamodel used in this running example is presented in Figure 11.1.

The aim of the pattern developed in this chapter (which we will call *PublicField*) is to identify quartets of <ClassDeclaration, FieldDeclaration, MethodDeclaration, MethodDeclaration>, each representing a field of a Java class for which appropriately named accessor/getter (getX/isX) and mutator/setter (setX) methods are defined by the class.

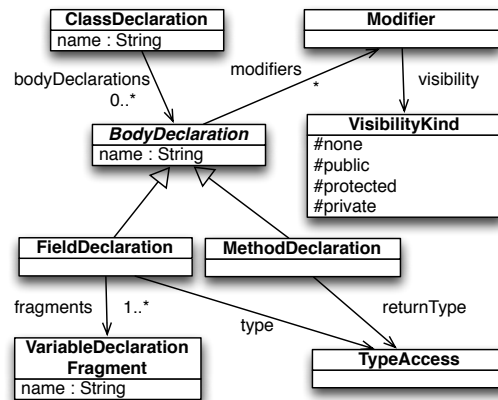

Figure 11.1: Simplified view of the MoDisco Java metamodel

<sup>1</sup><http://www.eclipse.org/MoDisco/>

## 11.2 Syntax

The syntax of EPL is an extension of the syntax of the EOL language, which – as discussed earlier – is the core language of Epsilon. As such, any references to *expression* and *statement block* in this chapter, refer to EOL expressions and blocks of EOL statements respectively. It is also worth noting that EOL expressions and statements can produce side-effects on models, and therefore, it is the responsibility of the developer to decide which expressions used in the context of EPL patterns should be side-effect free and which not.

As illustrated in Figure 11.2, EPL patterns are organised in *modules*. Each module contains a number of named *patterns* and optionally, *pre* and *post* statement blocks that are executed before and after the pattern matching process, and helper EOL operations. EPL modules can import other EPL and EOL modules to facilitate reuse and modularity.

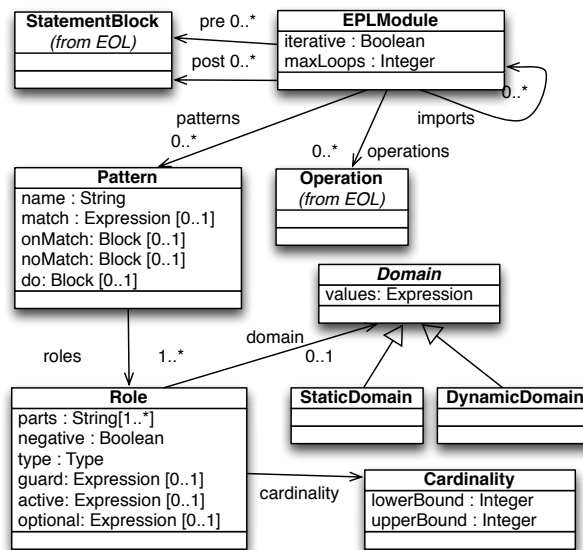

Figure 11.2: Abstract Syntax of EPL

In its simplest form a *pattern* consists of a number of named and typed *roles* and a *match* condition. For example, in lines 2-3, the *PublicField* pattern of Listing 11.1, defines four roles (*class*, *field*, *setter* and *getter*). The *match* condition of the pattern specifies that for a quartet to be a valid match, the field, setter and getter must all belong to the class (lines 5-7), and that the setter and getter methods must be appropriately named<sup>2</sup>.

<sup>2</sup>To maintain the running example simple and concise, the pattern does not check aspects such as matching/compatible parameter/return types in the field, setter and getter but the reader should easily be able to envision how this would be supported through additional clauses in the match condition.

```

1 pattern PublicField
2   class : ClassDeclaration, field : FieldDeclaration,
3   setter : MethodDeclaration, getter : MethodDeclaration {
4
5   match : class.bodyDeclarations.includes(field) and
6     class.bodyDeclarations.includes(setter) and
7     class.bodyDeclarations.includes(getter) and
8     setter.name = "set" + field.getName() and
9     (getter.name = "get" + field.getName() or
10    getter.name = "is" + field.getName())
11 }
12
13 @cached
14 operation FieldDeclaration getName() {
15   return self.fragments.at(0).name.firstToUpperCase();
16 }

```

Listing 11.1: First version of the PublicField pattern

The implementation of the PublicField pattern provided in Listing 11.1 is fully functional but not particularly efficient as the *match* condition needs to be evaluated  $\#ClassDefinition * \#FieldDeclaration * \#MethodDeclaration^2$  times. To enable pattern developers to reduce the search space, each *role* in an EPL pattern can specify a *domain* which is an EOL expression that returns a collection of model elements from which the role will draw values.

There are two types of domains in EPL: static domains which are computed once for all applications of the pattern, and which **are not** dependent on the bindings of other roles of the pattern (denoted using the *in* keyword in terms of the concrete syntax), and dynamic domains which are recomputed every time the candidate values of the role are iterated, and which **are** dependent on the bindings of other roles (denoted using the *from* keyword). Beyond a domain, each role can also specify a *guard* expression that further prunes unnecessary evaluations of the match condition. Using dynamic domains and guards, the *PublicField* pattern can be expressed in a more efficient way, as illustrated in Listing 11.2. To further illustrate the difference between dynamic and static domains, changing *from* to *in* in line 4 would trigger a runtime exception as the domain would become static and therefore not able to access bindings of other roles (i.e. *class*).

```

1 pattern PublicField
2   class : ClassDeclaration,
3   field : FieldDeclaration
4     from: class.bodyDeclarations,
5   setter : MethodDeclaration
6     from: class.bodyDeclarations
7     guard: setter.name = "set" + field.getName(),
8   getter : MethodDeclaration
9     from: class.bodyDeclarations
10    guard : (getter.name = "get" + field.getName() or
11            getter.name = "is" + field.getName()) { }

```

Listing 11.2: Second version of the PublicField pattern using domains and guards

The implementation of Listing 11.2 is significantly more efficient than the previous implementation but can still be improved by further reducing the number of name comparisons of candidate *setter* and *getter* methods. To achieve this we can employ memoisation: we create a hash map of method names and methods once before pattern matching (line 2), and use it to identify candidate setters and getters (lines 9 and 12-13).

```

1 pre {
2   var methodMap = MethodDeclaration.all.mapBy(m|m.name);
3 }
4 pattern PublicField
5   class : ClassDeclaration,
6   field : FieldDeclaration
7     from: class.bodyDeclarations,
8   setter : MethodDeclaration
9     from: getMethods("set" + field.getName())
10    guard: setter.abstractTypeDeclaration = class,
11   getter : MethodDeclaration
12     from: getMethods("get" + field.getName())
13           .includingAll(getMethods("is" + field.getName())),
14    guard: getter.abstractTypeDeclaration = class {
15 }
16
17 operation getMethods(name : String) : Sequence(MethodDeclaration) {
18   var methods = methodMap.get(name);
19   if (methods.isDefined()) return methods;
20   else return new Sequence;
21 }

```

Listing 11.3: Third version of the PublicField pattern

The sections below discuss the remainder of the syntax of EPL.

### 11.2.1 Negative Roles

Pattern roles can be negated using the *no* keyword. For instance, by adding the *no* keyword before the setter role in line 8 of Listing 11.3, the pattern will match fields that have getters but no setters (i.e. read-only fields).

### 11.2.2 Optional and Active Roles

Pattern roles can be designated as optional using the *optional* EOL expression. For example, adding `optional: true` to the setter role would also match all fields that only have a getter. By adding `optional: true` to the setter role and `optional: setter.isDefined()` to the getter role, the pattern would match fields that have at least a setter or a getter. Roles can be completely deactivated depending on the bindings of other roles through the *active* construct. For example, if the pattern developer prefers to specify separate roles for *getX* and *isX* getters, with a preference over *getX* getters, the pattern can be formulated as illustrated in Listing 11.4 so that if a *getX* getter is found, no attempt is even made to match an *isX* getter.

```
1 pattern PublicField
2   class : ClassDeclaration,
3   field : FieldDeclaration ...,
4   setter : MethodDeclaration ...,
5   getGetter : MethodDeclaration ...,
6   isGetter: MethodDeclaration
7   ...
8   active: getGetter.isUndefined() {
9 }
```

Listing 11.4: PublicField Pattern Version 4

### 11.2.3 Role Cardinality

The cardinality of a role (lower and upper bound) can be defined in square brackets following the type of the role. Roles that have a cardinality with an upper bound  $> 1$  are bound to the subset of elements from the domain of the role which also satisfy the guard, if the size of that subset is within the bounds of the role's cardinality. Listing 11.5 demonstrates the *ClassAndPrivateFields* pattern that detects instances of classes and all their private fields. If the cardinality of the field role in line 3 was `[1..3]` instead of `[*]`, the pattern would only detect classes that own 1 to 3 private fields.



```

1 pattern ClassAndPrivateFields
2   class : ClassDeclaration,
3   field : FieldDeclaration[*]
4     from: class.bodyDeclarations
5     guard: field.getVisibility() = VisibilityKind#private {
6
7     onmatch {
8       var message : String;
9       message = class.name + " matches";
10      message.println();
11    }
12
13    do {
14      // More actions here
15    }
16
17    nomatch : (class.name + " does not match").println()
18  }
19 operation FieldDeclaration getVisibility() {
20   if (self.modifier.isDefined()) {
21     return self.modifier.visibility; }
22   else { return null; }
23 }

```

Listing 11.5: Demonstration of Role Cardinality

## 11.3 Execution Semantics

When an EPL module is executed, all of its *pre* statement blocks are first executed in order to define and initialise any global variables needed (e.g. the *methodMap* variable in Listing 11.3) or to print diagnostic messages to the user. Subsequently, patterns are executed in the order in which they appear. For each pattern, all combinations that conform to the type and constraints of the roles of the pattern are iterated, and the validity of each combination is evaluated in the *match* statement block of the pattern. In the absence of a *match* block, every combination that satisfies the constraints of the roles of the pattern is accepted as a valid instance of the pattern.

Immediately after every successful match, the optional *onmatch* statement block of the pattern is invoked (see lines 7-11 of Listing 11.5) and after every unsuccessful matching attempt, for combinations which however satisfy the constraints specified by the roles of the pattern, the optional *nomatch* statement block of the pattern (line 17) is executed .

When matching of all patterns is complete, the *do* part (line 13) of each successful match is executed. In the *do* part, developers can modify the involved models (e.g to perform in-place transformation), without the risk of concurrent list modification errors (which can occur if elements are created/deleted during pattern matching). After pattern matching has been completed, the *post* statement blocks of the module are executed in order to perform any necessary finalisation actions.

An EPL module can be executed in a one-off or iterative mode. In the one-off mode, patterns are only evaluated once, while in the iterative mode, the process is repeated until no more matches have been found or until the maximum number of iterations (specified by the developer) has been reached. The iterative mode is particularly suitable for patterns that perform reduction of the models they are evaluated against.

## 11.4 Pattern Matching Output

The output of the execution of an EPL module on a set of models is a collection of matches encapsulated in a *PatternMatchModel*, as illustrated in Figure 11.3. As *PatternMatchModel* implements the *IModel* interface discussed in Chapter 2, its instances can be accessed from other programs expressed in languages of the Epsilon family.

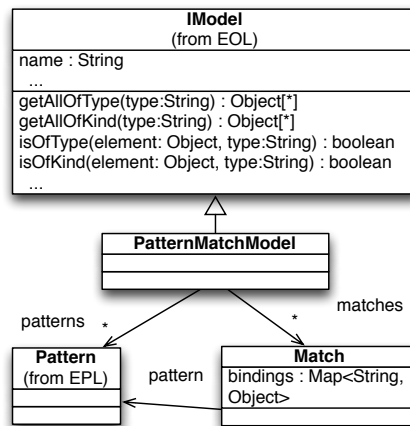

Figure 11.3: Pattern Matching Output

A *PatternMatchModel* introduces one model element type for each pattern and one type for each field of each pattern (the name of these types are derived by concatenating the name of the pattern with a camel-case version of the name of the field). Instances of the prior are the matches of the pattern while instances of the latter are elements that have

been matched in this particular role. For example, after executing the EPL module of Listing 11.3, the produced *PatternMatchModel* contains 5 types: *PublicField*, instances of which are all the identified matches of the *PublicField* pattern, *PublicFieldClass*, instances of which are all the classes in the input model which have been matched to the *class* role in instances of the *PublicField* pattern, and similarly *PublicFieldField*, *PublicFieldSetter* and *PublicFieldGetter*.

## 11.5 Interoperability with Other Model Management Tasks

As a *PatternMatchModel* is an instance of *IModel*, after its computation it can be manipulated by other Epsilon programs. For example, Listing 11.6 demonstrates running the EPL module of Listing 11.3 and passing its output to the EVL constraints module of Listing 11.7 and, if validation is successful, to an ETL transformation where it is used to guide the generation of a UML model.

In lines 4-7 of Listing 11.6 (see Chapter 14 for a detailed discussion on the Epsilon ANT tasks), the Java model is loaded and is assigned the name *Java*. Then, in line 9, the *Java* model is passed on to *publicfield.epl* for pattern matching. The result of pattern matching, which is an instance of the *PatternMatchModel* class (and therefore also an instance of *IModel*) is exported to the global context under the name *Patterns*. Then, in lines 13, both the *Patterns* and the *Java* are passed on to the EVL model validation task which performs validation of the identified pattern matches.

```
1 <project default="main">
2   <target name="main">
3
4     <epsilon.emf.loadModel name="Java"
5       modelfile="org.eclipse.epsilon.eol.engine_java.xmi"
6       metamodeluri="...MoDisco/Java/0.2.incubation/java"
7       read="true" store="false"/>
8
9     <epsilon.epl src="publicfield.epl" exportAs="Patterns">
10       <model ref="Java"/>
11     </epsilon.epl>
12
13     <epsilon.evl src="constraints.evl">
14       <model ref="Patterns"/>
15       <model ref="Java"/>
16     </epsilon.evl>
```

```

17
18 <epsilon.etl src="java2uml.etl">
19   <model ref="Patterns"/>
20   <model ref="Java"/>
21 </epsilon.etl>
22 </target>
23 </project>

```

Listing 11.6: ANT workflow calculating and passing a pattern match model to an EVL validation module

Line 1 of Listing 11.7 defines a set of constraints that will be applied to instances of the *PublicField* type from the *Patterns* model. As discussed above, these are all matched instances of the *PublicField* pattern. Line 4, specifies the condition that needs to be satisfied by instances of the pattern. Notice the *self.getter* and *self.field* expressions which return the *MethodDeclaration* and *FieldDeclaration* bound to the instance of the pattern. Then, line 5 defines the message that should be produced for instances of *PublicField* that do not satisfy this constraint.

```

1 context Patterns!PublicField {
2   guard: self.field.type.isDefined()
3   constraint GetterAndFieldSameType {
4     check : self.getter.returnType.type = self.field.type.type
5     message : "The getter of " + self.class.name + "."
6       + self.field.fragments.at(0).name +
7       " does not have the same type as the field itself"
8   }
9 }

```

Listing 11.7: Fragment of the constraints.evl EVL constraints module

If validation is successful, both the *Java* and the *Patterns* model are passed on to an ETL transformation that transforms the *Java* model to a UML model, a fragment of which is presented in Listing 11.8. The transformation encodes  $\langle field, setter, getter \rangle$  triplets in the *Java* model as public properties in the UML model. As such, in line 6 of the transformation, the *Patterns* model is used to check whether field *s* has been matched under the *PublicField* pattern, and if so, the next line ignores the field's declared visibility and sets the visibility of the respective UML property to *public*.

```

1 rule FieldDeclaration2Property
2   transform s: Java!FieldDeclaration
3   to t: Uml!Property {
4
5     t.name = s.getName();

```

```
6  if (s instanceof (Patterns!PublicFieldField)) {
7    t.visibility = Uml!VisibilityKind#public;
8  }
9  else {
10   t.visibility = s.toUmlVisibility();
11 }
12 ...
13 }
```

Listing 11.8: Fragment of the java2uml.etl Java to UML ETL transformation

As Epsilon provides ANT tasks for all its languages, the same technique can be used to pass the result of pattern matching on to model-to-text transformations, as well as model comparison and model merging programs.



# Chapter 12

## The Epsilon Model Generation Language (EMG)

### 12.1 Background and Motivation

At some point, programs written in any of the Epsilon model management languages might need to be tested in order to find defects (bugs) and assert their correctness, or benchmarked in order to assess their performance. Both testing and benchmarking activities require appropriate test data, i.e. models that conform to specific metamodels and their constraints, satisfy additional requirements or characteristics (e.g. certain size), and/or contain data and provide a structure that exercises particular aspects of the program under test.

Manual assembly of test models is an error prone, time and labour consuming activity. This type of activities are perfect candidates for automation. Given that it is also a model management activity, it follows that the automation can be provided by a model generation engine that can execute model generation scripts. The scripts should be written in a model generation language that allows the user to generate models that conform to specific metamodels and its arbitrarily complex constraints (e.g constraints formulated in compound first-order OCL operations), satisfy particular characteristics, and contain specific data and exhibit particular structures. The model generation engine should exhibit characteristics such as randomness, repeatability, scalability and easy parametrization [32, 33].

The Epsilon Model Generation Language addresses the automated generation of complex models.

### 12.1.1 Approaches to Model Generation

The model generation approaches found in literature provide fully-automated behaviour. In a fully-automated approach, the tool loads the metamodel (and in some cases its constraints) and generates models that conform to the metamodel (and satisfy the constraints, if constraints are supported). However, the existing solutions can generate invalid models and in the case where constraints are supported, only simple constraints are supported.

The Epsilon Model Generation follows a semi-automated generation approach. There are three main tasks in model generation:

- Create instances of types in the metamodel(s).
- Assign values to the instance's attributes (properties typed by primitive types: String, Integer, etc.).
- Create links between instances to assign values to references (properties typed by complex types: other types in the metamodel).

In the semi-automated approach, all of these tasks can be configured to execute statically or dynamically (with randomness). Statically, the user must specify every single aspect of the generation. Dynamically, for example, the number of instances to create of a given type can be random, or the value of a given attribute can be set to random values, or the links between elements can be done between random pairs of elements. The combination of random and static definition of the generation tasks allows the user to generate models that can satisfy complex constraints, guarantee additional characteristics and exercise particular aspects of the program under test.

This chapter discusses the concrete syntax of EMG as well as its execution semantics. To aid understanding, the discussion of the syntax and the semantics of the language revolves around an exemplar generation which is developed incrementally throughout the chapter.

## 12.2 Syntax

The EMG language does not provide additional syntax. Instead it provides a set of predefined annotations that can be added to EOL operations and EPL patterns in order to perform the model generation. The predefined EOL operation annotations are:

**instances** Defines the number of instances to create. This annotation accepts one parameter. The parameter can be an expression that resolves to an Integer (e.g. literal,



variable name, etc.) or a sequence in the form `Sequence {min, max}`). An integer value statically defines how many instances are to be created. A sequence defines a range that is used by the engine to generate a random number  $n$  of instances, with  $min \leq n \leq max$ .

**list** Defines an identifier (listID) for a placeholder list for the elements created. This annotation accepts one parameter. The parameter is the identifier (String) that can later be used in operations that accept it as an argument in order to access the elements created by the operation.

**parameters** If the instantiated type accepts/needs arguments for instantiation, the parameters annotation can be used to provide them. This annotation accepts one parameter. The parameter must be a Sequence that contains the desired arguments in the order expected by the constructor.

All three annotations are executable and hence must be prefixed with a \$ symbol when used. Further, these annotations are only evaluated on *create* operations (see Section 12.3).

The EPL pattern annotations are:

**number** This limits the number of times the pattern is matched, to constraint the number of links created between elements. This annotation accepts one parameter. The parameter can be an expression that resolves to an Integer (e.g. literal, variable name, etc.) or a sequence in the form `Sequence {min, max}`). An integer value statically defines how many instances are to be created. A sequence defines a range that is used by the engine to generate a random number  $n$  of instances, with  $min \leq n \leq max$ .

**probability** This defines the probability that the body of the pattern will be executed for a matching set of elements. The effect is that not all matching elements are linked. Effectively this also limits the number of times links are created.

**noRepeat** This forbids previous matched elements to be re-linked.

The first two annotations are executable and hence must be prefixed with a \$ symbol when used and the last one is a simple annotation and must be prefixed with @.

Additionally the EMG engine provides a set of predefined operations that provide support for generating random data that can be used to set the attributes and references of the generated model elements, to select random elements from collections, etc.

## 12.2.1 EMG predefined operations

Table 12.1: Emg data generation operations

Signature	Description
<code>nextAddTo(n : Integer, m : Integer): Sequence(Integer)</code>	Returns a sequence of <code>n</code> integers whose sum is equal to <code>m</code> .
<code>nextBoolean()</code>	Returns the next pseudorandom, uniformly distributed <code>boolean</code> value.
<code>nextCamelCaseWords(charSet : String, length : Integer, minWordLength : Integer) : String</code>	Generates a string of the given length formatted as CamelCase, with subwords of a minimum length of the <code>minWordLength</code> argument, using characters from the given <code>charSet</code> (see <a href="#">12.2.1</a> ).
<code>nextCapitalisedWord(charSet : String, length : Integer) : String</code>	Generate a Capitalized string of the given length using characters from the given <code>charSet</code> (see <a href="#">12.2.1</a> ).
<code>nextFromCollection(c : Sequence) : Any</code>	Returns the next <code>object</code> from the collection, selected pseudorandomly using the uniform distribution. If the collection is empty, returns <code>null</code> .
<code>nextFromList(listID : String) : Any</code>	Returns the next <code>object</code> from the list, selected pseudorandomly using the uniform distribution. If the list is empty, returns <code>null</code> . The <code>listID</code> can either be a name defined by the <code>@list</code> annotation or a parameter name from the run configuration. In the latter case, the parameter value can be either a comma separated string or a file path. If it is a comma separated string, then a list is created by splitting the string, if the value is a path, then the file will be read and each line will be treated as a list element.
<code>nextFromListAsSample(listID : String) : Any</code>	Same as <code>nextFromList</code> , but in this case the list is treated as a sample without replacement, i.e. each call will return a unique member of the list.

nextHttpURI(addPort : Boolean, addPath : Boolean, addQuery : Boolean, addFragment : Boolean) : String	Generates a random URI that complies to <code>http://host[:port]][/]/path[?query][#fragment]</code> . The path, query and fragment parts are optional and will be added if the respective argument is True.
nextInt() : Integer	Returns the next pseudorandom, uniformly distributed integer. All $2^{32}$ possible integer values should be produced with (approximately) equal probability.
nextInt(upper : Integer) : Integer	Returns a pseudorandom, uniformly distributed integer value between 0 (inclusive) and <i>upper</i> (exclusive). The argument must be positive.
nextInt(lower: Integer, upper : Integer) : Integer	Returns a pseudorandom, uniformly distributed integer value between lower and upper (endpoints included). The arguments must be positive and <i>upper</i> $\geq$ <i>lower</i> .
nextReal() : Real	Returns the next pseudorandom, uniformly distributed <code>real</code> value between 0.0 and 1.0.
nextReal(upper : Real) : Real	Returns the next pseudorandom, uniformly distributed <code>real</code> value between 0.0 and <i>upper</i> (inclusive).
nextReal(lower: Real, upper : Real) : Real	Returns a pseudorandom, uniformly distributed <code>real</code> value between <i>lower</i> and <i>upper</i> (endpoints included).
nextSample(c : Sequence, k : Integer) : Sequence(Any)	Returns a Sequence of <i>k</i> objects selected randomly from the Sequence <i>c</i> using a uniform distribution. Sampling from <i>c</i> is without replacement; but if <i>c</i> contains identical objects, the sample may include repeats. If all elements of <i>c</i> are distinct, the resulting object collection represents a Simple Random Sample of size <i>k</i> from the elements of <i>c</i> .

nextSample(listID : String, k : Integer) : Sequence(Any)	Same as nextSample but the sequence is referenced by <i>listID</i> . The <i>listID</i> has the same meanings as for operation <i>nextFromList</i> .
nextString() : String	Returns the next string made up from characters of the LETTER character set (see 12.2.1), pseudorandomly selected with a uniform distribution. The length of the string is between 4 and 10 characters.
nextString(length : Integer) : String	Returns the next String made up from characters of the LETTER character set (see 12.2.1), pseudorandomly selected with a uniform distribution. The length of the String is equal to <i>length</i> .
nextString(charSet : String, length : Integer) : String	Returns the next String of the given <i>length</i> using the specified character set (see 12.2.1), pseudorandomly selected with a uniform distribution.
nextURI() : String	Generates a random URI that complies to: scheme:[//[user:password]host[:port]][/]path[?query][#fragment]. The port, path, query and fragment are added randomly. The scheme is randomly selected from: http, ssh and ftp. For ssh and ftp, a user and password are randomly generated. The host is generated from a random string and uses a top-level domain. The number of paths and queries are random between 1 and 4.
nextURI(addPort : Boolean, addPath : Boolean, addQuery : Boolean, addFragment : Boolean) : String	Same as nextURI, but the given arguments control what additional port, path, query and fragment information is added.
nextUUID() : String	Returns a type 4 (pseudo randomly generated) UUID. The UUID is generated using a cryptographically strong pseudo random number generator.

nextValue() : Real	Returns the next pseudorandom value, picked from the configured distribution (by default the uniform distribution is used).
nextValue(d : String, p : Sequence) : Real	Returns the next pseudorandom, from the provided distribution <i>d</i> . The parameters <i>p</i> are used to configure the distribution (if required). The supported distributions are: Binomial, Exponential and Uniform. For Binomial parameters are: numberOfTrials and probabilityOfSuccess. For Exponential the mean. For Uniform the lower and upper values (lower inclusive).
setNextValueDistribution(d : String, p : Sequence)	Define the distribution to use for calls to <i>nextValue()</i> . Parameters are the same as for <i>nextValue(d, p)</i> .

### Character Sets for String operations

For the operations that accept a character set, the supported sets are defined as follows:

Table 12.2: Operations of type Any

Name	Characters
ID	abcdefghijklmnopqrstuvwxyz ABCDEFGHIJKLMNOPQRSTUVWXYZ 1234567890
NUMERIC	1234567890
LETTER	abcdefghijklmnopqrstuvwxyz ABCDEFGHIJKLMNOPQRSTUVWXYZ
LETTER_UPPER	ABCDEFGHIJKLMNOPQRSTUVWXYZ
LETTER_LOWER	abcdefghijklmnopqrstuvwxyz
UPPER_NUM	ABCDEFGHIJKLMNOPQRSTUVWXYZ 1234567890
LOWER_NUM	abcdefghijklmnopqrstuvwxyz 1234567890

ID_SYMBOL	abcdefghijklmnopqrstuvwxyz JKLMNOPQRSTUVWXYZ ~}!@#\$%^&*()_+ -=[] \   ; : " < > ? , . /	ABCDEFGHI- 1234567890
HEX_LOWER	abcdef1234567890	
HEX_UPPER	ABCDEF1234567890	

### 12.3 Creating Model Elements

The EMG engine will search for EOL operations that follow a particular signature in order to determine what elements to create in the generated model. The signature is: `create <OutputType> () { ... }`. That is, the operation must be named *create*, the operation's context type defines the type of the created instance and no parameters should be passed. By default the create operation only creates one instance. Hence, the provided annotations can be used to tailor the behaviour of the operation.

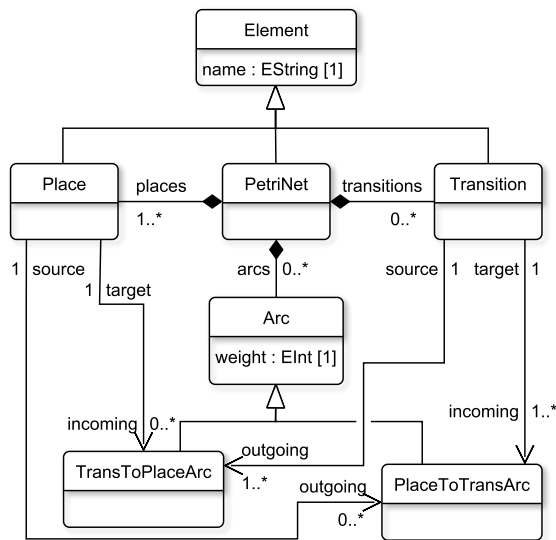

Figure 12.1: PetriNet metamodel

Consider the case of the PetriNet metamodel in Figure 12.1. The code excerpt displayed in Listing 12.1 creates a PetriNet and then adds some places and transitions to it. Note that the instances annotation is executable and hence you can use absolute values, variables

or expressions. The `list` annotation in the PetriNet creation will result in all PetriNet instances to be stored in a sequence called *net*. The list name is then used in the Place and Transition create operations to add the places and transitions to a random (*nextFromList*) PetriNet. In this example there is only one, but we could easily create more PetriNet instances and hence have them contain random number of Places and Transitions. The name of the elements is generated using the random string generation facilities.

```
1 pre {
2   var num_p = 10
3 }
4
5 $instances 1
6 @list net
7 operation PetriNet create() {
8   self.name = nextCamelCaseWords("LETTER_LOWER", 15, 10);
9 }
10
11 $instances num_p
12 operation Place create() {
13   self.name = "P_" + nextString("LETTER_LOWER", 15);
14   nextFromList("net").transitions.add(self);
15 }
16
17 $instances num_p / 2
18 operation Transition create() {
19   self.name = "T_" + nextString("LETTER_LOWER", 15);
20   nextFromList("net").transitions.add(self);
21 }
```

Listing 12.1: EMG create operations

## 12.4 Creating Model Links

In the previous section, the *places* and *transitions* references of the PetriNet were defined during the creation of the Place and Transition elements. For more complex reference patterns, EMG leverages the use of EPL patterns. For example, Arcs can have complex constraints in order to determine the source and target transition/place, and possibly even having separate rules for each type of Arc.

The EPL pattern in Listing 12.2 creates two arcs in order to connect a source and a target Place via a Transition. The pattern matches all transitions in a given PetriNet. The pattern body selects a random Place for the source and a random Place for the target (the while loops are used to pick places that have the lowest incoming/outgoing arcs possible). The weight of the arc is generated randomly from 0 to 10 (*nextInt(10)*). The pattern has

been annotated with the `@probability` annotation which will effectively only use 70% of the transitions to create arcs (i.e. of all the possible PetriNet-Transition matches, the code of the pattern will only be executed with a probability of 0.70).

```
1 @probability 0.7
2 pattern Transition
3 net:PetriNet,
4 tra:Transition
5 from: net.transitions {
6   onmatch {
7     var size = 0;
8     var freeSources = Place.all().select(s | s.incoming.size() == size);
9     while (freeSources.isEmpty()) {
10      size += 1;
11      freeSources = Place.all().select(s | s.incoming.size() == size);
12    }
13    size = 0;
14    var freeTarget = Place.all().select(s | s.outgoing.size() == size);
15    while (freeTarget.isEmpty()) {
16      size += 1;
17      freeTarget = Place.all().select(s | s.outgoing.size() == size);
18    }
19    var source = nextFromCollection(freeSources);
20    var target = nextFromCollection(freeTarget);
21    var a1:Arc = new PlaceToTransArc();
22    a1.weight = nextInt(10);
23    a1.source = source;
24    net.places.add(source);
25    a1.target = tra;
26    net.arcs.add(a1);
27    var a2:Arc = new TransToPlaceArc();
28    a2.weight = nextInt(10);
29    a2.source = tra;
30    a2.target = target;
31    net.places.add(target);
32    net.arcs.add(a2);
33  }
34 }
```

Listing 12.2: EMG create operations

## 12.5 Meaningful Strings

In some scenarios having completely random Strings for some of the element fields might not be desirable. In this case EMG has an embedded mechanism to facilitate the use of meaningful attribute values (not only for Strings) and we show a second approach based on additional models.



## 12.5.1 Values as a parameter

The `nextFromList()` operation will first look for a list with that name, if it can't find it will look for a parameter (from the run configuration) with that name. The value of the parameter can be either an absolute path to a file or a comma separated list of values.

If it is a comma separated list of values, then the individual values will be loaded as a Collection. For example, if we added the parameter `names: John, Rose, Juan, Xiang, Joe` to the run configuration, Listing 12.3 shows how to use that information to define the instance attributes.

```
1 $instances num_p
2 operation Place create() {
3     self.name = nextFromList("name");
4     nextFromList("net").transitions.add(self);
5 }
```

Listing 12.3: EMG create operations

If it is a file path, then each line of the file will be loaded as an item to the Collection. Note that the distinction between paths and comma separated values is the assumption that paths don't contain commas.

## 12.5.2 Values as a model

A more powerful approach would be to use an existing model to serve as the source for attribute values. Given that there are several websites<sup>1</sup> to generate random data in the form of CSV files, we recommend the use of a CSV model to serve as an attribute value source. A CSV file with `name`, `lastName`, and `email` can be easily generated and loaded as a second model the the EMG script. Then, a Row of data can be picked randomly to set an element's attributes. Listing 12.4 shows this approach.

```
1 $instances num_p
2 operation Person create() {
3     var p = nextFromCollection(dataModel.Row.all());
4     self.name = p.name;
5     self.lastName = p.lastName;
6     self.email = p.email;
7 }
```

Listing 12.4: EMG create operations

---

<sup>1</sup><https://www.mockaroo.com/>, <https://www.generatedata.com/>, [www.freedatagenerator.com/](http://www.freedatagenerator.com/), etc.

Note that in this case, by using different rows for each value you can further randomize the data.

# Chapter 13

## Implementing a New Task-Specific Language

Although Epsilon already provides languages for a wide range of model management tasks, additional tasks that could benefit from the convenience syntax and dedicated semantics of a task-specific language are likely to be identified in the future. Thus, this section distills the experiences obtained through the construction of existing task-specific languages to provide guidance on how to identify a task for which a dedicated language can be beneficial and develop the respective task-specific language for it atop the infrastructure provided by Epsilon.

### 13.1 Identifying the need for a new language

The first step of the process of constructing a new task-specific language is to identify a specific task for which a dedicated language is more appropriate than the general-purpose EOL. Typically, recurring syntactic and semantic patterns that emerge when attempting to implement the task using EOL indicate that a new task-specific language may be useful.

For example, before the introduction of the Epsilon Comparison Language, pure EOL was being used to perform model comparison. A simple comparison specification that establishes name-based matches between classes/attributes and tables/columns between two OO and DB models respectively using EOL is demonstrated in Listing 13.1.

Two patterns can be readily detected by inspecting the EOL code in Listing 13.1. First, explicit variables (*matchingCT*, *matchingAT*) are defined to capture the matching elements (class-table and attribute-column) identified during the comparison process. Also, to check all elements of one type (classes against tables and attributes against columns) repeated for statements are used in lines 3–4 and 7–8. By contrast, Listing 13.2 which is specified

using the task-specific ECL language does not include such low-level information. Instead it defines only the types of elements that need to be compared and the criteria on which comparison must be performed and leaves the mundane tasks of scheduling and maintaining the match trace to the execution engine.

```
1 var matchingCT : Sequence;
2 var matchingAC : Sequence;
3 for (c in OO!Class.allInstances) {
4   for (t in DB!Table.allInstances) {
5     if (t.name = c.name) {
6       matchingCT.add(Sequence{c,t});
7       for (att in c.attributes) {
8         for (col in t.columns) {
9           if (att.name = c.name) {
10            matchingAC.add(Sequence{att, col});
11          }
12        }
13      }
14    }
15  }
16 }
```

Listing 13.1: Comparing an OO model with a DB model using EOL

```
1 rule ClassTable
2   match c : OO!Class
3   with t : DB!Table {
4
5     compare : c.name = t.name
6   }
7
8 rule AttributeColumn
9   match a : OO!Attribute
10  with c : DB!Column {
11
12    compare : a.name = c.name and
13      a.class.matches(c.table)
14 }
```

Listing 13.2: Comparing an OO model with a DB model using ECL

## 13.2 Eliciting higher-level constructs from recurring patterns

Once recurring patterns, such as those discussed above, have been identified, the next step of the process is to derive higher level constructs from them. For instance, in the previous example, the nested for loops and the explicit trace variable declaration and population have been replaced by task-specific match rules.

Introducing higher-level involves defining its abstract and concrete syntax as well as its connection points with the underlying infrastructure. For example, in the case of ECL, the types of match rules are EOL model element types, the *guard* and *check* parts of a rule are EOL expressions or statements blocks and the *pre* and *post* blocks as well as the *do* part of each rule are blocks of EOL statements.

## 13.3 Implement Execution Semantics and Scheduling

Once higher-level constructs (e.g. task-specific rules) have been identified and specified, their execution semantics and scheduling must be implemented similarly to what has been done for existing languages. Development of existing languages has demonstrated that task-specific constructs often need to provide more than one modes of execution (e.g. the *lazy* and *greedy* modes of ETL transformation rules discussed in Section 5.5).

A lightweight way to easily provide new execution modes and semantics for rules and user-defined operations without modifying the syntax of the language and introducing new keywords that may conflict with existing code, is through the annotations mechanism provided by EOL (see Section 3.2.1). This approach has been adopted for the definition a small unit-testing language (EUnit), which is discussed in detail in [34].

## 13.4 Overriding Semantics

In certain cases, it is useful to modify the semantics of certain constructs in EOL to meet the purposes of the task-specific language. An example of such a modification occurs in EVL where – as discussed in Section 4.4 – the scope of the variables defined in *guard* expression/block is extended so that variables can be reused in the context of non-nested blocks such as the *title*, and *check* parts of the invariant. Another example of overriding the semantics of EOL is the implementation of the special assignment operator ( $::=$ ) by ETL which was discussed in 5.5.4.



# Chapter 14

## Orchestration Workflow

The previous chapters provided a detailed discussion on a number of task-specific languages, each one addressing an individual model management task. However, in practice, model management tasks are seldom carried out in isolation; instead, they are often combined together to form complex workflows. Therefore, of similar importance to the existence of individual task-specific management languages is the provision of a mechanism that enables developers to compose modular and reusable tasks into complex automated processes. In a broader context, to facilitate implementation of seamless workflows, an appropriate MDE workflow mechanism should also support mainstream development tasks such as file management, version control management, source code compilation and invocation of external programs and services.

### 14.1 Motivation

As a motivating example, an exemplar workflow that consists of both MDD tasks (1-4, 6) and mainstream software development tasks (5, 7) is displayed below.

1. Load a UML model
2. Validate it
3. Transform it into a Database Schema model
4. Generate Java code from the UML model
5. Compile the Java code
6. Generate SQL code from the Database model

## 7. Deploy the SQL code in a Database Management System (DBMS)

In the above workflow, if the validation step (2) fails, the entire process should be aborted and the identified errors should be reported to the user. This example demonstrates that to be of practical use, a task orchestration framework needs to be able to coordinate both model management and mainstream development tasks and provide mechanisms for establishing dependencies between different tasks.

This chapter presents such a framework for orchestrating modular model management tasks implemented using languages of the Epsilon platform. As the problem of task coordination is common in software development, many technical solutions have been already proposed and are widely used by software practitioners. In this context, designing a new general-purpose workflow management solution was deemed inappropriate. Therefore, the task orchestration solution discussed here has been designed as an extension to the robust and widely used ANT [35] framework. A brief overview of ANT as well as a discussion on the choice to design the orchestration workflow of Epsilon atop it is provided below.

## 14.2 The ANT Tool

ANT, named so because it is *a little thing that can be used to build big things* [36], is a robust and widely-used framework for composing automated workflows from small reusable activities. The most important advantages of ANT, compared to traditional build tools such as *gnumake* [37], is that it is platform independent and easily extensible. Platform independence is achieved by building atop Java, and extensibility is realized through a lightweight binding mechanism that enables developers to contribute custom tasks using well defined interfaces and extension points.

Although a number of tools with functionality similar to ANT exist in the Java community, only Maven [38] is currently of comparable magnitude in terms of user-basis size and robustness. Outlining the discussion provided in [39], ANT is considered to be easier to learn and to enable low-level control, while Maven is considered to provide a more elaborate task organization scheme. Nevertheless, the two frameworks are significantly similar and the ANT technical solution discussed in this chapter can easily be ported to work with the latter.

This section provides a brief discussion of the structure and concrete syntax of ANT workflows, as well as the extensibility mechanisms that ANT provides to enable users contribute custom tasks.



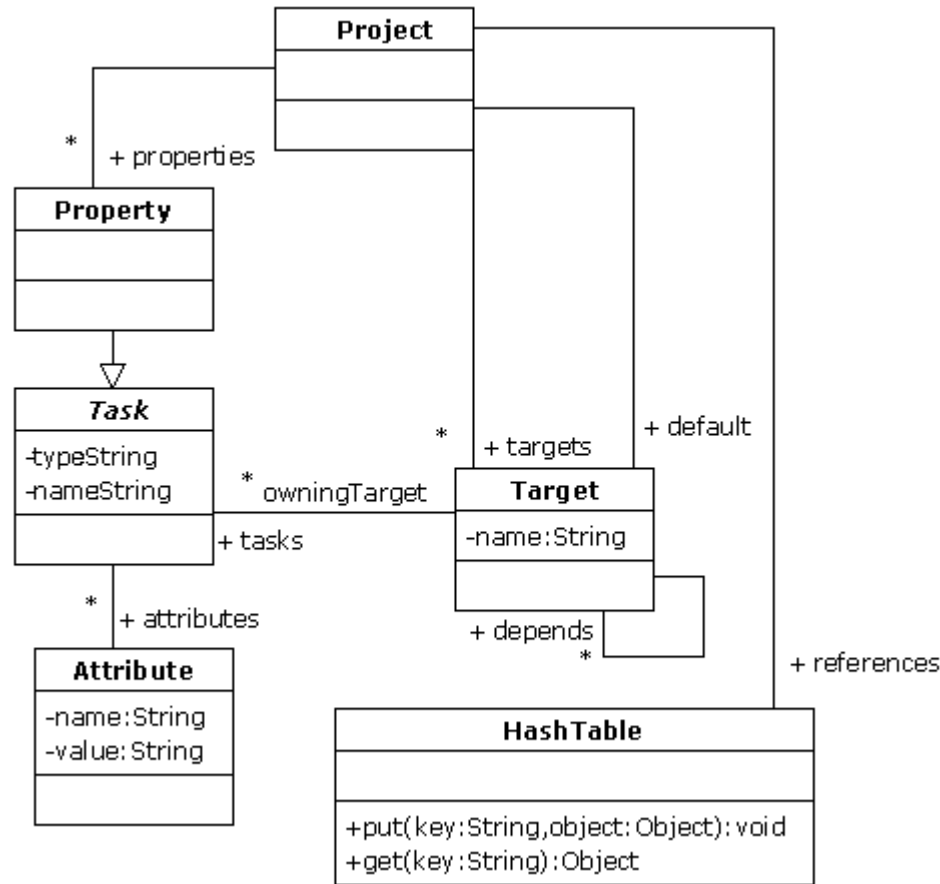

Figure 14.1: Simplified ANT object model

### 14.2.1 Structure

In ANT, each workflow is captured as a *project*. A simplified illustration of the structure of an ANT project is displayed in Figure 14.1. Each ANT project consists of a number of *targets*. The one specified as the *default* is executed automatically when the project is executed. Each *target* contains a number of *tasks* and *depends* on other targets that must be executed before it. An ANT task is responsible for a distinct activity and can either succeed or fail. Exemplar activities implemented by ANT tasks include file system management, compiler invocation, version management and remote artefact deployment.

### 14.2.2 Concrete Syntax

In terms of concrete syntax, ANT provides an XML-based syntax. In Listing 14.1, an exemplar ANT project that compiles a set of Java files is illustrated. The project contains one target (*main*) which is also set to be the *default* target. The *main* target contains one *javac*

task that specifies attributes such as *srcdir*, *destdir* and *classpath*, which define that the Java compiler will compile a set of Java files contained into the *src* directory into classes that should be placed in the *build* directory using *dependencies.jar* as an external library.

```
1 <project default="main">
2   <target name="main"/>
3     <javac srcdir="${src}"
4         destdir="${build}"
5         classpath="dependencies.jar"
6         debug="on"
7         source="1.4"/>
8   </target>
9 </project>
```

Listing 14.1: Compiling Java classes using the javac task

### 14.2.3 Extending ANT

Binding between the XML tags that describe the tasks and the actual implementations of the tasks is achieved through a light-weight mechanism at two levels. First, the tag (in the example of Listing 14.1, *javac*) is resolved to a Java class that extends the *org.apache.ant.Task* abstract class (in the case of *javac*, the class is *org.apache.tools.ant.taskdefs.Javac*) via a configuration file. Then, the attributes of the tasks (e.g. *srcdir*) are set using the reflective features that Java provides. Finally, the *execute()* method of the task is invoked to perform the actual job.

This lightweight and straightforward way of defining tasks has rendered ANT particularly popular in the Java development community and currently there is a large number of tasks contributed by ANT users [40], ranging from invoking tools such as code generators and XSLT processors, to emulating logical control flow structures such as *if* conditions and *while* loops. The AMMA platform [41] also provides integration of model driven engineering tools such as TCS [42] and ATL [6] with ANT.

ANT also supports more advanced features including nested XML elements and *file-sets*, however providing a complete discussion is beyond the scope of this chapter. For a definitive guide to ANT readers can refer to [36].

## 14.3 Integration Challenges

A simple approach to extending ANT with support for model management tasks would be to implement one standalone task for each language in Epsilon. However, such an

approach demonstrates a number of integration and performance shortcomings which are discussed below.

Since models are typically serialized in the file system, before a task is executed, the models it needs to access/modify must be parsed and loaded in memory. In the absence of a more elaborate framework, each model management task would have to take responsibility for loading and storing the models it operates on. Also, in most workflows, more than one task operates on the same models sequentially, and needlessly loading/storing the same models many times in the context of the same workflow is an expensive operation both time and memory-wise, particularly as the size of models increases.

Another weakness of this primitive approach is limited inter-task communication. In the absence of a communication framework that allows model management tasks to exchange information with each other, it is often the case that many tasks end up performing the same (potentially expensive) queries on models. By contrast, an inter-task communication framework would enable time and resource intensive calculations to be performed once and their results to be communicated to all interested subsequent tasks.

Having discussed ANT, Epsilon and the challenges their integration poses, the following sections presents the design of a solution that enables developers to invoke model management tasks in the context of ANT workflows. The solution consists of a core framework that addresses the challenges discussed in Section 14.3, a set of specific tasks, each of which implements a distinct model management activity, and a set of tasks that enable developers to initiate and manage transactions on models using the respective facilities provided by the model connectivity layer discussed in Section 2.6.

## 14.4 Framework Design and Core Tasks

The role of the core framework, illustrated in Figure 14.2, is to provide model loading and storing facilities as well as runtime communication facilities to the individual model management tasks that build atop it. This section provides a detailed discussion of the components it consists of.

### 14.4.1 The EpsilonTask task

An ANT task can access the project in which it is contained by invoking the *Task.getProject()* method. To facilitate sharing of arbitrary information between tasks, ANT projects provide two convenience methods, namely *addReference(String key, Object ref)* and *getRef-*

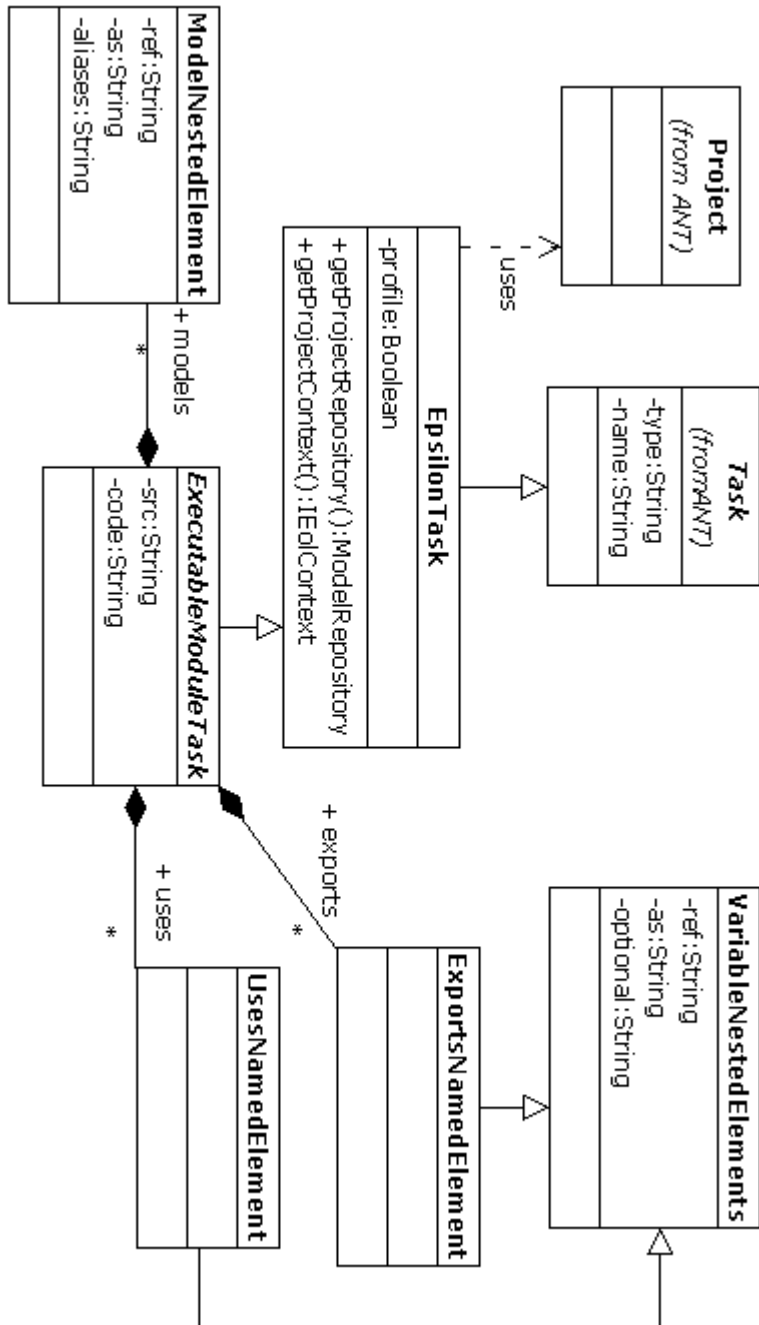

Figure 14.2: Core Framework

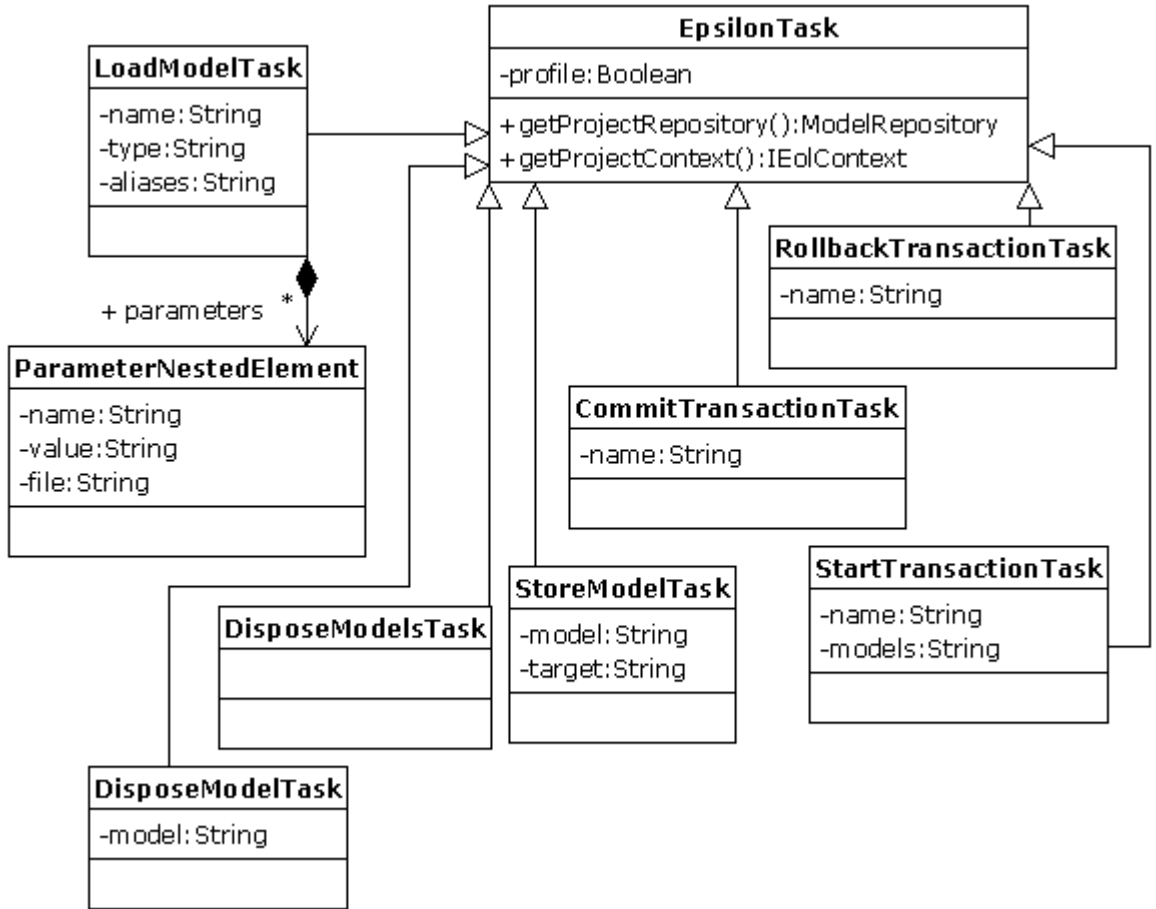

Figure 14.3: Core Models Framework

*erence(String key) : Object*. The former is used to add key-value pairs, which are then accessible using the latter from other tasks of the project.

To avoid loading models multiple times and to enable on-the-fly management of models from different Epsilon modules without needing to store and re-load the models after each task, a reference to a project-wide model repository has been added to the current ANT project using the *addReference* method discussed above. In this way, all the subclasses of the abstract *EpsilonTask* can invoke the *getProjectRepository()* method to access the project model repository.

Also, to support a variable sharing mechanism that enables inter-task communication, the same technique has been employed; a shared context, accessible by all Epsilon tasks via the *getProjectContext()* method, has been added. Through this mechanism, model management tasks can export variables to the project context (e.g. traces or lists containing results of expensive queries) which other tasks can then reuse.

*EpsilonTask* also specifies a *profile* attribute that defines if the execution of the task must

be profiled using the profiling features provided by Epsilon. Profiling is a particularly important aspect of workflow execution, especially where model management languages are involved. The main reason is that model management languages tend to provide convenient features which can however be computationally expensive (such as the *allInstances()* EOL built-in feature that returns all the instances of a specific metaclass in the model) and when used more often than really needed, can significantly degrade the overall performance.

## 14.4.2 Model Loading Tasks

The *LoadModelTask* (*epsilon.loadModel*) loads a model from an arbitrary location (e.g. file-system, database) and adds it to the project repository so that subsequent Epsilon tasks can query or modify it. Since Epsilon supports many modelling technologies (e.g. EMF, MDR, XML), the *LoadModelTask* defines only three generic attributes. The *name* attribute specifies the name of the model in the project repository. The *type* attribute specifies the modelling technology with which the model is captured and is used to resolve the technology-specific model loading functionality. Finally, the *aliases* attribute defines a comma-separated list of alternative names by which the model can be accessed in the model repository.

The rest of the information needed to load a model is implementation-specific and is therefore provided through *parameter* nested elements, each one defining a pair of *name-value* attributes. As an example, a task for loading an EMF model that has a file-based ECore metamodel is displayed in Listing 14.2.

```
1 <epsilon.loadModel name="Tree1" type="EMF">
2   <parameter name="modelFile" value="TreeInstance.ecore"/>
3   <parameter name="metamodelFile" path="Tree.ecore"/>
4   <parameter name="isMetamodelFileBased" value="true"/>
5   <parameter name="readOnLoad" value="true"/>
6 </epsilon.loadModel>
```

Listing 14.2: Loading an EMF model using the *epsilon.loadModel* task

*LoadEmfModelTask* is a specialised version of *LoadModelTask* only for EMF models. While the *type* attribute is no longer available, the task still supports the *name* and *aliases* attributes. In addition, some of the values which had to be provided through *parameter* nested elements can now be set using regular attributes, such as *modelFile*, *modelUri*, *metamodelFile* (which implicitly indicates that the metamodel is file-based), *metamodelUri*, *reuseUnmodifiedMetamodelFile* (which can be set to “false” to avoid reusing file-based metamodels that have not been modified since the last time they were loaded), *read*

```
1 <epsilon.emf.loadModel name="Tree1"  
2   modelFile="TreeInstance.ecore"  
3   metamodelFile="Tree.ecore" />
```

Listing 14.3: Loading an EMF model using the `epsilon.emf.loadModel` task

(equivalent to `readOnLoad`) and `store` (equivalent to `storeOnDisposal`). Listing 14.3 shows the equivalent fragment required to produce the same result as in Listing 14.2.

### 14.4.3 Model Storing Task

The `StoreModelTask` (`epsilon.storeModel`) is used to store a model residing in the project repository. The `StoreModelTask` defines three attributes:

- `name` (required): name of the model to be stored.
- `targetUri` (optional): URI where the model will be stored (e.g. “file:/path/to/destination”).
- `target` (optional): file path where the model will be stored (e.g. “file.xml”).

`targetUri` takes precedence over `target`. If neither is defined, then the model is stored in the location from which it was originally loaded.

### 14.4.4 Model Disposal Tasks

When a model is no longer required by tasks of the workflow, it can be disposed using the `epsilon.disposeModel` task. The task provides the `model` attribute that defines the name of the model to be disposed. Also, the attribute-less `epsilon.disposeModels` task is provided that disposes all the models in the project model repository. This task is typically invoked when the model management part of the workflow has finished.

The workflow leverages the model-transaction services provided by the model connectivity framework of Epsilon by providing three tasks for managing transactions in the context of workflows.

### 14.4.5 The StartTransaction Task

The `epsilon.startTransaction` task defines a `name` attribute that identifies the transaction. It also optionally defines a comma-separated list of model names (`models`) that the transaction will manage. If the `models` attribute is not specified, the transaction involves all the models contained in the common project model repository.

## 14.4.6 The CommitTransaction and RollbackTransaction Tasks

The *epsilon.commitTransaction* and *epsilon.rollbackTransaction* tasks define a *name* attribute through which the transaction to be committed/rolled-back is located in the project's active transactions. If several active transactions with the same name exist the more recent one is selected.

The example of Listing 14.4 demonstrates an exemplar usage of the *epsilon.startTransaction* and *epsilon.rollbackTransaction* tasks. In this example, two empty models Tree1 and Tree2 are loaded in lines 1,2. Then, the EOL task of line 4 queries the models and prints the number of instances of the *Tree* metaclass in each one of them (which is 0 for both). Then, in line 13, a transaction named T1 is started on model Tree1. The EOL task of line 15, creates a new instance of Tree in both Tree1 and Tree2 and prints the number of instances of Tree in the two models (which is 1 for both models). Then, in line 26, the T1 transaction is rolled-back and any changes done in its context to model Tree1 (but not Tree2) are undone. Therefore, the EOL task of line 28, which prints the number of instances of Tree in both models, prints 0 for Tree1 but 1 for Tree2.

```
1 <epsilon.loadModel name="Tree1" type="EMF">...</epsilon.loadModel>
2 <epsilon.loadModel name="Tree2" type="EMF">...</epsilon.loadModel>
3
4 <epsilon.eol>
5   <![CDATA[
6     Tree1!Tree.allInstances.size().println(); // prints 0
7     Tree2!Tree.allInstances.size().println(); // prints 0
8   ]]>
9   <model ref="Tree1"/>
10  <model ref="Tree2"/>
11 </epsilon.eol>
12
13 <epsilon.startTransaction name="T1" models="Tree1"/>
14
15 <epsilon.eol>
16   <![CDATA[
17     var t1 : new Tree1!Tree;
18     Tree1!Tree.allInstances.size().println(); // prints 1
19     var t2 : new Tree2!Tree;
20     Tree2!Tree.allInstances.size().println(); // prints 1
21   ]]>
22   <model ref="Tree1"/>
23   <model ref="Tree2"/>
24 </epsilon.eol>
25
```



```

26 <epsilon.rollbackTransaction name="T1"/>
27
28 <epsilon.eol>
29 <![CDATA[
30   Tree1!Tree.allInstances.size().println(); // prints 0
31   Tree2!Tree.allInstances.size().println(); // prints 1
32   ]]>
33 <model ref="Tree1"/>
34 <model ref="Tree2"/>
35 </epsilon.eol>

```

Listing 14.4: Exemplar usage of the *epsilon.startTransaction* and *epsilon.rollbackTransaction* tasks

### 14.4.7 The Abstract Executable Module Task

This task is the base of all the model management tasks presented in Section 14.5. Its aim is to encapsulate the commonalities of Epsilon tasks in order to reduce duplication among them. As already discussed, in Epsilon, specifications of model management tasks are organized in executable modules. While modules can be stored anywhere, in the case of the workflow it is assumed that they are either stored as separate files in the file-system or they are provided inline within the workflow. Thus, this abstract task defines an *src* attribute that specifies the path of the source file in which the Epsilon module is stored, but also supports inline specification of the source of the module. The two alternatives are demonstrated in Listings 14.5 and 14.6 respectively.

```

1 <project default="main">
2   <target name="main">
3     <epsilon.eol src="HelloWorld.eol"/>
4   </target>
5 </project>

```

Listing 14.5: External Module Specification

```

1 <project default="main">
2   <target name="main">
3     <epsilon.eol>
4       <![CDATA[
5         "Hello world".println();
6       ]]>
7     </epsilon.eol>
8   </target>

```

```
9 </project>
```

### Listing 14.6: Inline Module Specification

Optionally, users can enable debugging for the module to be run by setting the *debug* attribute to *true*. An example is shown in Listing 14.7. If the module reaches a breakpoint, users will be able to run the code step by step and inspect the stack trace and its variables.

```
1 <project default="main">
2   <target name="main">
3     <epsilon.eol src="HelloWorld.eol" debug="true"/>
4   </target>
5 </project>
```

### Listing 14.7: Inline Module Specification

The task also defines the following nested elements:

**0..n *model* nested elements** Through the *model* nested elements, each task can define which of the models, loaded in the project repository it needs to access. Each *model* element defines three attributes. The *ref* attribute specifies the name of the model that the task needs to access, the *as* attribute defines the name by which the model will be accessible in the context of the task, and the *aliases* defines a comma-delimited sequence of aliases for the model in the context of the task.

**0..n *parameter* nested elements** The *parameter* nested elements enable users to communicate String parameters to tasks. Each *parameter* element defines a *name* and a *value* attribute. Before executing the module, each *parameter* element is transformed into a String variable with the respective name and value which is then made accessible to the module.

**0..n *exports* nested elements** To facilitate low-level integration between different Epsilon tasks, each task can export a number of variables to the project context, so that subsequent tasks can access them later. Each *export* nested element defines the three attributes. The *ref* attribute specifies the name of the variable to be exported, the *as* string attribute defines the name by which the variable is stored in the project context and the *optional* boolean attribute specifies whether the variable is mandatory. If *optional* is set to *false* and the module does not specify such a variable, an ANT *BuildException* is raised.

**0..n *uses* nested elements** The *uses* nested elements enable tasks to import variables exported by previous Epsilon tasks. Each use element supports three attributes. The *ref*

attribute specifies the name of the variable to be used. If there is no variable with this name in the project context, the ANT project properties are queried. This enables Epsilon modules to access ANT parameters (e.g. provided using command-line arguments). The *as* attribute specifies the name by which the variable is accessible in the context of the task. Finally, the *optional* boolean parameter specifies if the variable must exist in the project context.

To better illustrate the runtime communication mechanism, a minimal example is provided in Listings 14.8 - 14.10. In Listing 14.8, *Exporter.eol* defines a String variable named *x* and assigns a value to it. The workflow of Listing 14.10 specifies that after executing *Exporter.eol*, it must export a variable named *x* with the new name *y* to the project context. Finally, it defines that before executing *User.eol* (Listing 14.9), it must query the project context for a variable named *y* and in case this is available, add the variable to the module's context and then execute it. Thus, the result of executing the workflow is *Some String* printed in the output console.

```
1 var x : String = "Some string";
```

Listing 14.8: Source code of the *Exporter.eol* module

```
1 z.println();
```

Listing 14.9: Source code of the *User.eol* module

```
1 <epsilon.eol src="Exporter.eol">
2   <exports ref="x" as="y"/>
3 </epsilon.eol>
4
5 <epsilon.eol src="User.eol">
6   <uses ref="y" as="z"/>
7 </epsilon.eol>
```

Listing 14.10: ANT Workflow connecting modules 14.8 and 14.9 using the *epsilon.eol* task

## 14.5 Model Management Tasks

Having discussed the core framework, this section presents the model management tasks that have been implemented atop it, using languages of the Epsilon platform.

### 14.5.1 Generic Model Management Task

The *epsilon.eol* task executes an EOL module, defined using the *src* attribute on the models that are specified using the *model* nested elements.

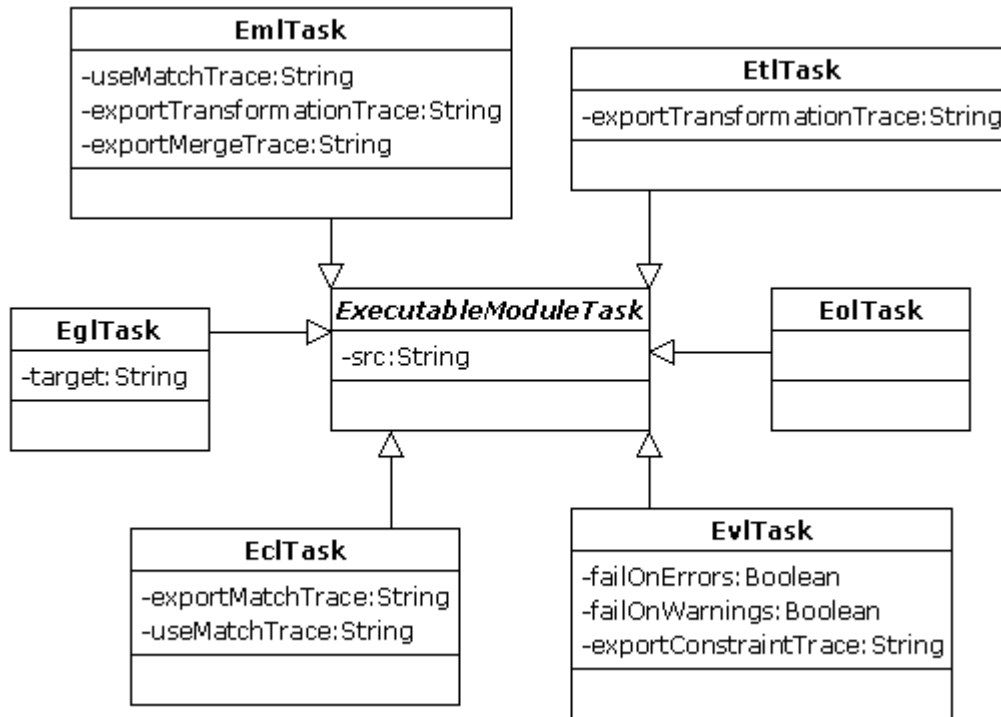

Figure 14.4: Model Management Tasks

## 14.5.2 Model Validation Task

The *epsilon.evl* task executes an EVL module, defined using the *src* attribute on the models that are specified using the *model* nested elements. In addition to the attributes defined by the *ExecutableModuleTask*, this task also provides the following attributes:

- *failOnErrors* : Errors are the results of unsatisfied constraints. Setting the value of this attribute to *true* (default is *false*) causes a *BuildException* to be raised if one or more errors are identified during the validation process.
- *failOnWarnings* : Similarly to errors, warnings are the results of unsatisfied critiques. Setting the value of this attribute to *true* (default is also *false*) causes a *BuildException* to be raised if one or more warnings are identified during the validation process.
- *exportConstraintTrace* : This attribute enables developers to export the internal constraint trace constructed during model validation to the project context so that it can be later accessed by other tasks - which could for example attempt to automatically repair the identified inconsistencies.

- *exportAsModel* : Setting the value of this attribute to *true* (default is *false*) causes EVL to export the results of the validation as a new model in the project repository, named “EVL”. This model contains all the EVLUNSATISFIEDCONSTRAINTS found by EVL. These instances contain several useful attributes: *constraint* points to the EVLCONSTRAINT with the definition of the constraint and *instance* points to the model element which did not satisfy the constraint. From the EVLCONSTRAINT, *isCritique* can be used to check if it is a critique or not, and *name* contains the name of the constraint.

### 14.5.3 Model-to-Model Transformation Task

The *epsilon.etl* task executes an ETL module, defined using the *src* attribute to transform between the models that are specified using the *model* nested elements. In addition to the attributes defined by the ExecutableModuleTask, this task also provides the *exportTransformationTrace* attribute that enables the developer to export the internal transformation trace to the project context. In this way this trace can be reused by subsequent tasks; for example another task can serialize it in the form of a separate traceability model.

### 14.5.4 Model Comparison Task

The *epsilon.ecl* task executes an ECL module, defined using the *src* attribute to establish matches between elements of the models that are specified using the *model* nested elements. In addition to the attributes defined by the ExecutableModuleTask, this task also provides the *exportMatchTrace* attribute that enables users to export the match-trace calculated during the comparison to the project context so that subsequent tasks can reuse it. For example, as discussed in the sequel, an EML model merging task can use it as a means of identifying correspondences on which to perform merging. In another example, the match-trace can be stored by a subsequent EOL task in the form of an stand-alone weaving model.

### 14.5.5 Model Merging Task

The *epsilon.eml* task executes an EML module, defined using the *src* attribute on the models that are specified using the *model* nested elements. In addition to the attributes defined by the ExecutableModuleTask, this task also provides the following attributes:

- *useMatchTrace* : As discussed in 9, to merge a set of models, an EML module needs an established match-trace between elements of the models. The *useMatchTrace* at-

tribute enables the EML task to use a match-trace exported by a preceding ECL task (using its *exportMatchTrace* attribute).

- *exportMergeTrace*, *exportTransformationTrace* : Similarly to ETL, through these attributes an EML task can export the internal traces calculated during merging for subsequent tasks to use.

## 14.5.6 Model-to-Text Transformation Task

To support model to text transformations, *EglTask* (*epsilon.egl*) task is provided that executes an Epsilon Generation Language (EGL) module<sup>1</sup>. In addition to the attributes defined by *ExecutableModuleTask*, *EglTask* also defines the following attributes:

- *target* : Defines a file in which all of the generated text will be stored.
- *templateFactoryType* : Defines the Java class that will be instantiated to provide a *TemplateFactory* for the EGL program. The specified class must be on the classpath and must subtype *EglTemplateFactory*. See Section 7.4.4 for more information.

*EglTask* may nest any number of *formatter* elements. The *formatter* nested element has the following attributes:

- *implementation* (required) : Defines the Java class that will be instantiated to provide a *Formatter* for the EGL program. The specified class must be on the classpath and must subtype *Formatter*. See Section 7.6.2 for more information.

## 14.5.7 Model Migration Task

To support model migration, *FlockTask* (*epsilon.flock*) is provided for executing an Epsilon Flock module (Chapter 10). In addition to the attributes defined by *ExecutableModuleTask*, *FlockTask* also defines the following mandatory attributes:

- *originalModel* : Specifies which of the currently loaded models should be used as the source of the model migration.
- *migratedModel* : Specifies which of the currently loaded models should be used as the target of the model migration.

---

<sup>1</sup>As discussed in Section 7 EGL has been built atop Epsilon with a minimal contribution of the author

### 14.5.8 Pattern Matching Task

The *epsilon.epl* task executes an EPL module, defined using the *src* attribute to perform pattern matching on the models that are specified using the *model* nested elements. In addition to the attributes defined by the *ExecutableModuleTask*, this task also provides the following attributes.

- *repeatWhileMatches*: A boolean specifying whether the pattern matching process should continue to execute for as long as matches are found.
- *maxLoops*: An integer specifying the maximum number of pattern matching iterations.
- *exportAs*: The name under which the computed pattern match model should be made available to other Epsilon tasks of the workflow.

## 14.6 Miscellaneous Tasks

### 14.6.1 Java Class Static Method Execution Task

The *epsilon.java.executeStaticMethod* task executes a parameter-less static method, defined using the *method* attribute, of a Java class, defined using the *javaClass* attribute. This task can be useful for setting up the infrastructure of Xtext-based languages.

### 14.6.2 Adding a new Model Management Task

As discussed in Section 13, additional task-specific languages are likely to be needed in the future for tasks that are not effectively supported by existing task-specific languages. In addition to designing and implementing the syntax and execution semantics of a new language, it is also important to provide integration with the workflow – if the nature of the language permits execution within a workflow. As a counter-example, no workflow task has been provided for EWL since its execution semantics is predominately user-driven and as such, it makes little sense to execute EWL in the context of an automated workflow.

To implement support for a new task-specific language to the workflow, a new extension of the abstract *ExecutableModuleTask* needs to be provided (similarly to what has been done for existing task-specific languages). By extending *ExecutableModuleTask*, the task is automatically provided with access to the essential features of the workflow such as the shared model repository, and runtime context. Additional configuration options for the

task need to specified as new ANT *attributes* and/or *nested elements*, similarly to what has been done for the tasks presented in Sections 14.5.1–14.5.6.

## 14.7 Chapter Summary

This chapter has presented the detailed design of an ANT-based framework for integrating and orchestrating mainstream software development tasks with model management tasks implemented using model management languages in Epsilon. In Section 14.4, the core framework that provides features such as centralized model loading/storing facilities, a shared model repository and a mechanism through which individual tasks can communicate at runtime has been illustrated. Then, Section 14.5 has provided a discussion on the integration of the task specific languages with the framework and also provided guidance for adding support for additional languages that are likely to be developed in the future atop Epsilon.



# Chapter 15

## The Epsilon Unit Testing Framework (EUnit)

EUnit is an unit testing framework specifically designed to test model management tasks, based on EOL and the Ant workflow tasks. It provides assertions for comparing models, files and directories. Tests can be reused with different sets of models and input data, and differences between the expected and actual models can be graphically visualized. This chapter discusses the motivation behind EUnit, describes how tests are organized and written and shows two examples of how a model-to-model transformation can be tested with EUnit. This chapter ends with a discussion of how EUnit can be extended to support other modelling and model management technologies.

### 15.1 Motivation

Model-driven approaches are being adopted in a wide range of demanding environments, such as finance, health care or telecommunications [43]. In this context, validation and verification is identified as one of the many challenges of model-driven software engineering (MDSE) [44].

MDSE in practice involves creating models, and thereafter *managing* them, via various tasks, such as model transformation, validation and merging. The validation and verification of each type of model management task has its own specific challenges. Kolovos et al. list testing concerns for model-to-model (M2M) and model-to-text (M2T) transformations, model validations, model comparisons and model compositions in [34]. Baudry et al. identify three main issues when testing model transformations [32]: the complexity of the input and output models, the immaturity of the model management environments and the large number of different transformation languages and techniques.

### 15.1.1 Common Issues

While each type of model management task does have specific complexity, some of the concerns raised by Baudry can be generalized to apply to all model management tasks:

- There is usually a large number of models to be handled. Some may be created by hand, some may be generated using hand-written programs, and some may be generated automatically following certain coverage criteria.
- A single model or set of models may be used in several tasks. For instance, a model may be validated before performing an in-place transformation to assist the user, and later on it may be transformed to another model or merged with a different model. This requires having at least one test for each valid combination of models and sets of tasks.
- Test oracles are more complex than in traditional unit testing [45]: instead of checking scalar values or simple lists, entire graphs of model objects or file trees may have to be compared. In some cases, complex properties in the generated artifacts may have to be checked.
- Models and model management tasks may use a wide range of technologies. Models may be based on Ecore [46], XML files or Java object graphs, among many others. At the same time, tasks may use technologies from different platforms, such as Epsilon, oAW [47] or AMMA [41]. Many of these technologies offer high-level tools for running and debugging the different tasks using several models. However, users wishing to do automated unit testing need to learn low-level implementation details about their modelling and model management technologies. This increases the initial cost of testing these tasks and hampers the adoption of new technologies.
- Existing testing tools tend to focus on the testing technique itself, and lack integration with external systems. Some tools provide graphical user interfaces, but most do not generate reports which can be consumed by a continuous integration server, for instance.

### 15.1.2 Testing with JUnit

The previous issues are easier to understand with a concrete example. This section shows how a simple transformation between two EMF models in ETL using JUnit 4 [48] would be normally tested, and points out several issues due to JUnit's limitations as a general-purpose unit testing framework for Java programs.

For the sake of brevity, only an outline of the JUnit test suite is included. All JUnit test suites are defined as Java classes. This test suite has three methods:

1. The test setup method (marked with the `@Before` JUnit annotation) loads the required models by creating and configuring instances of `EMFMODEL`. After that, it prepares the transformation by creating and configuring an instance of `ETLMODULE`, adding the input and output models to its model repository.
2. The test case itself (marked with `@Test`) runs the ETL transformation and uses the generic comparison algorithm implemented by EMF Compare to perform the model comparison.
3. The test teardown method (marked with `@After`) disposes of the models.

Several issues can be identified in each part of the test suite. First, test setup is tightly bound to the technologies used: it depends on the API of the `EMFMODEL` and `ETLMODULE` classes, which are both part of Epsilon. Later refactorings in these classes may break existing tests.

The test case can only be used for a single combination of input and output models. Testing several combinations requires either repeating the same code and therefore making the suite less maintainable, or using parametric testing, which may be wasteful if not all tests need the same combinations of models.

Model comparison requires the user to manually select a model comparison engine and integrate it with the test. For comparing EMF models, EMF Compare is easy to use and readily available. However, generic model comparison engines may not be available for some modelling technologies, or may be harder to integrate.

Finally, instead of comparing the obtained and expected models, several properties could have been checked in the obtained model. However, querying models through Java code can be quite verbose.

### 15.1.3 Selected Approach

Several approaches could be followed to address these issues. Our first instinct would be to extend JUnit and reuse all the tooling available for it. A custom test runner would simplify setup and teardown, and modelling platforms would integrate their technologies into it. Since Java is very verbose when querying models, the custom runner should run tests in a higher-level language, such as EOL. However, JUnit is very tightly coupled to Java, and this would impose limits on the level of integration we could obtain. For instance, errors

in the model management tasks or the EOL tests could not be reported from their original source, but rather from the Java code which invoked them. Another problem with this approach is that new integration code would need to be written for each of the existing platforms.

Alternatively, we could add a new language exclusively dedicated to testing to the Epsilon family. Being based on EOL, model querying would be very concise, and with a test runner written from scratch, test execution would be very flexible. However, this would still require all platforms to write new code to integrate with it, and this code would be tightly coupled to Epsilon.

As a middle ground, we could decorate EOL to guide its execution through a new test runner, while reusing the Apache Ant [35] tasks already provided by several of the existing platforms, such as AMMA or Epsilon. Like Make, Ant is a tool focused on automating the execution of processes such as program builds. Unlike Make, Ant defines processes using XML *buildfiles* with sets of interrelated *targets*. Each target contains in turn a sequence of *tasks*. Many Ant tasks and Ant-based tools already exist, and it is easy to create a new Ant task.

Among these three approaches, EUnit follows the last one. Ant tasks take care of model setup and management, and tests are written in EOL and executed by a new test runner, written from the ground up.

## 15.2 Test Organization

EUnit has a rich data model: test suites are organized as trees of tests, and each test is divided into many parts which can be extended by the user. This section is dedicated to describing how test suites and tests are organized. The next section indicates how they are written.

### 15.2.1 Test Suites

EUnit test suites are organized as trees: inner nodes group related test cases and define *data* bindings. Leaf nodes define *model* bindings and run the test cases.

Data bindings repeat all test cases with different values in one or more variables. They can implement parametric testing, as in JUnit 4. EUnit can nest several data bindings, running all test cases once for each combination.

Model bindings are specific to EUnit: they allow developers to repeat a single test case with different subsets of models. Data and model bindings can be combined. One

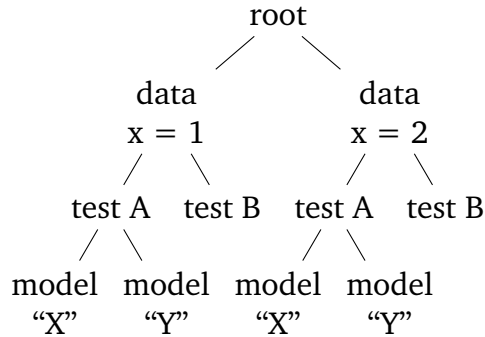

Figure 15.1: Example of an EUnit test tree

interesting approach is to set the names of the models to be used in the model binding from the data binding, as a quick way to try several test cases with the same subsets of models.

Figure 15.1 shows an example of an EUnit test tree: nodes with data bindings are marked with `data`, and nodes with model bindings are marked with `model`. EUnit will perform a preorder traversal of this tree, running the following tests:

1. A with  $x = 1$  and model X.
2. A with  $x = 1$  and model Y.
3. B with  $x = 1$  and both models.
4. A with  $x = 2$  and model X.
5. A with  $x = 2$  and model Y.
6. B with  $x = 2$  and both models.

Optionally, EUnit can filter tests by name, running only *A* or *B*. Similarly to JUnit, EUnit logs start and finish times for each node in the tree, so the most expensive test cases can be quickly detected. However, EUnit logs CPU time<sup>1</sup> in addition to the usual wallclock time.

Parametric testing is not to be confused with *theories* [49]: both repeat a test case with different values, but results are reported quite differently. While parametric testing produces separate test cases with independent results, theories produce aggregated tests which only pass if the original test case passes for every data point. Figure 15.2 illustrates these differences. EUnit does not support theories yet: however, they can be approximated with data bindings.

<sup>1</sup>CPU time only measures the time elapsed in the thread used by EUnit, and is more stable with varying system load in single-threaded programs.

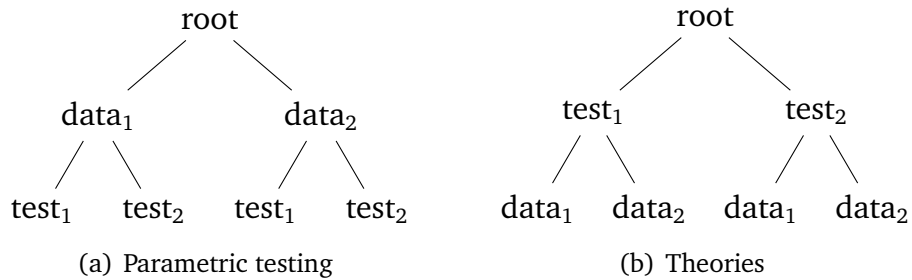

Figure 15.2: Comparison between parametric testing and theories

## 15.2.2 Test Cases

The execution of a test case is divided into the following steps:

1. Apply the data bindings of its ancestors.
2. Run the model setup sections defined by the user.
3. Apply the model bindings of this node.
4. Run the regular setup sections defined by the user.
5. Run the test case itself.
6. Run the teardown sections defined by the user.
7. Tear down the data bindings and models for this test.

An important difference between JUnit and EUnit is that setup is split into two parts: model setup and regular setup. This split allows users to add code before and after model bindings are applied. Normally, the model setup sections will load all the models needed by the test suite, and the regular setup sections will further prepare the models selected by the model binding. Explicit teardown sections are usually not needed, as models are disposed automatically by EUnit. EUnit includes them for consistency with the xUnit frameworks.

Due to its focus on model management, model setup in EUnit is very flexible. Developers can combine several ways to set up models, such as model references, individual Apache Ant [35] tasks, Apache Ant targets or Human-Usable Text Notation (HUTN) [50] fragments.

A test case may produce one among several results. `SUCCESS` is obtained if all assertions passed and no exceptions were thrown. `FAILURE` is obtained if an assertion failed. `ERROR` is obtained if an unexpected exception was thrown while running the test. Finally, tests may be `SKIPPED` by the user.

## 15.3 Test Specification

In the previous section, we described how test suites and test cases are organized. In this section, we will show how to write them.

As discussed before, after evaluating several approaches, we decided to combine the expressive power of EOL and the extensibility of Apache Ant. For this reason, EUnit test suites are split into two files: an Ant buildfile and an EOL script with some special-purpose annotations. The next subsections describe the contents of these two files and revisit the previous example with EUnit.

### 15.3.1 Ant Buildfile

EUnit uses standard Ant buildfiles: running EUnit is as simple as using its Ant task. Users may run EUnit more than once in a single Ant launch: the graphical user interface will automatically aggregate the results of all test suites.

#### EUnit Invocations

An example invocation of the EUnit Ant task using the most common features is shown in Listing 15.1. Users will normally only use some of these features at a time, though. Optional attributes have been listed between brackets. Some nested elements can be repeated 0+ times (\*) or 0-1 times (?). Valid alternatives for an attribute are separated with |.

```
1 <epsilon.eunit src="..."
2   [failOnErrors="..."]
3   [package=".."]
4   [toDir="..."]
5   [report="yes|no"]>
6   (<model      ref="OldName" [as="NewName"] />)*
7   (<uses       ref="x" [as="y"] />)*
8   (<exports    ref="z" [as="w"] />)*
9   (<parameter name="myparam" value="myvalue" />)*
10  (<modelTasks><!-- Zero or more Ant tasks --></modelTasks>)?
11 </epsilon.eunit>
```

Listing 15.1: Format of an invocation of the EUnit Ant task

The EUnit Ant task is based on the Epsilon abstract executable module task (see Section 14.4.7), inheriting some useful features. The attribute *src* points to the path of the EOL file, and the optional attribute *failOnErrors* can be set to *false* to prevent EUnit

from aborting the Ant launch if a test case fails. EUnit also inherits support for importing and exporting global variables through the `<uses>` and `<exports>` elements: the original name is set in `ref`, and the optional `as` attribute allows for using a different name. For receiving parameters as name-value pairs, the `<parameter>` element can be used.

Model references (using the `<model>` nested element) are also inherited from the Epsilon abstract executable module task. These allow model management tasks to refer by name to models previously loaded in the Ant buildfile. However, EUnit implicitly reloads the models after each test case. This ensures that test cases are isolated from each other.

The EUnit Ant task adds several new features to customize the test result reports and perform more advanced model setup. By default, EUnit generates reports in the XML format of the Ant `<junit>` task. This format is also used by many other tools, such as the TestNG unit testing framework [51], the Jenkins continuous integration server [52] or the JUnit Eclipse plug-ins. To suppress these reports, `report` must be set to `no`.

By default, the XML report is generated in the same directory as the Ant buildfile, but it can be changed with the `toDir` attribute. Test names in JUnit are formed by its Java package, class and method: EUnit uses the filename of the EOL script as the class and the name of the EOL operation as the method. By default, the package is set to the string “default”: users are encouraged to customize it with the `package` attribute.

The optional `<modelTasks>` nested element contains a sequence of Ant tasks which will be run after reloading the model references and before running the model setup sections in the EOL file. This allows users to run workflows more advanced than simply reloading model references, such as the one in Listing 15.5.

## Helper Targets

Ant buildfiles for EUnit may include *helper targets*. These targets can be invoked using `runTarget("targetName")` from anywhere in the EOL script. Helper targets are quite versatile: called from an EOL model setup section, they allow for reusing model loading fragments between different EUnit test suites. They can also be used to invoke the model management tasks under test. Listing 15.5 shows a helper target for an ETL transformation, and listing 15.9 shows a helper target for an ATL transformation.

### 15.3.2 EOL script

The Epsilon Object Language script is the second half of the EUnit test suite. EOL annotations are used to tag some of the operations as data binding definitions (`@data` or `@Data`), additional model setup sections (`@model/@Model`), test setup and teardown sections



(`@setup/@Before` and `@teardown/@After`) and test cases (`@test/@Test`). Suite setup and teardown sections can also be defined with `@suitesetup/@BeforeClass` and `@suiteteardown/@AfterClass` annotations: these operations will be run before and after all tests, respectively.

## Data bindings

Data bindings repeat all test cases with different values in some variables. To define a data binding, users must define an operation which returns a sequence of elements and is marked with `@data variable`. All test cases will be repeated once for each element of the returned sequence, setting the specified variable to the corresponding element. Listing 15.2 shows two nested data bindings and a test case which will be run four times: with  $x=1$  and  $y=5$ ,  $x=1$  and  $y=6$ ,  $x=2$  and  $y=5$  and finally  $x=2$  and  $y=6$ . The example shows how  $x$  and  $y$  could be used by the setup section to generate an input model for the test. This can be useful if the intent of the test is ensuring that a certain property holds in a class of models, rather than a single model.

```
1 @data x
2 operation firstLevel() { return 1.to(2); }
3
4 @data y
5 operation secondLevel() { return 5.to(6); }
6
7 @setup
8 operation generateModel() { -* generate model using x and y *- }
9
10 @test
11 operation mytest() { -* test with the generated model *- }
```

Listing 15.2: Example of a 2-level data binding

Alternatively, if both  $x$  and  $y$  were to use the same sets of values, we could add two `@data` annotations to the same operation. For instance, Listing 15.3 shows how we could test with 4 cases:  $x=1$  and  $y=1$ ,  $x=1$  and  $y=2$ ,  $x=2$  and  $y=1$  and  $x=2$  and  $y=2$ .

```
1 @data x
2 @data y
3 operation levels() { return 1.to(2); }
4
5 @setup
6 operation generateModel() { -* generate model using x and y *- }
7
8 @test
```

```

1 $with Map {"" = "A", "Other" = "B"}
2 $with Map {"" = "B", "Other" = "A"}
3 @test
4 operation mytest() {
5     /* use the default and Other models, while
6       keeping the rest as is */
7 }
8
9 $onlyWith Map { "Model" = "A" }
10 $onlyWith Map { "Model" = "B" }
11 @test
12 operation mytest2() {
13     -- first time: A as 'Model', B is unavailable
14     -- second time: B as 'Model', A is unavailable
15 }

```

Listing 15.4: Examples of model bindings

```

9 operation mytest() { /* test with the generated model */ }

```

Listing 15.3: Example of reusing the same operation for several data bindings

## Model bindings

Model bindings repeat a test case with different subsets of models. They can be defined by annotating a test case with `$with map` or `$onlyWith map` one or more times, where `map` is an EOL expression that produces a MAP. For each key-value pair `key = value`, EUnit will rename the model named `value` to `key`. The difference between `$with` and `$onlyWith` is how they handle the models not mentioned in the MAP: `$with` will preserve them as is, and `$onlyWith` will make them unavailable during the test. `$onlyWith` is useful for tightly restricting the set of available models in a test and for avoiding ambiguous type references when handling multiple models using the same metamodel.

Listing 15.4 shows two tests which will be each run twice. The first test uses `$with`, which preserves models not mentioned in the MAP: the first time, model “A” will be the default model and model “B” will be the “Other” model, and the second time, model “B” will be the default model and model “A” will be the “Other” model. The second test uses two `$onlyWith` annotations: on the first run, “A” will be available as “Model” and “B” will not be unavailable, and on the second run, only “B” will be available as “Model” and “A” will be unavailable.

## Additional variables and built-in operations

EUnit provides several variables and operations which are useful for testing. These are listed in Table 15.1.

Table 15.1: Extra operations and variables in EUnit

Signature	Description
<code>runTarget(name : String)</code>	Runs the specified target of the Ant buildfile which invoked EUnit.
<code>exportVariable(name : String)</code>	Exports the specified variable, to be used by another executable module (see Section 14.4.7).
<code>useVariable(name : String)</code>	Imports the specified variable, which should have been previously exported by another executable module (see Section 14.4.7).
<code>loadHutn(name : String, hutn : String)</code>	Loads an EMF model with the specified name, by parsing the second argument as an HUTN [50] fragment.
<code>antProject</code> <code>org.apache.tools.ant.Project</code>	: Global variable which refers to the Ant project being executed. This can be used to create and run Ant tasks from inside the EOL code.

## Assertions

EUnit implements some common assertions for equality and inequality, with special versions for comparing floating-point numbers. EUnit also supports a limited form of exception testing with `assertError`, which checks that the expression inside it throws an exception. Custom assertions can be defined by the user with the `fail` operation, which fails a test with a custom message. The available assertions are shown in Table 15.2. Table 15.3 lists the available option keys which can be used with the model equality assertions, by comparator.

Table 15.2: Assertions in EUnit

Signature	Description
<code>assertEqualDirectories(   expectedPath : String,   obtainedPath : String)</code>	Fails the test if the contents of the directory in <i>obtainedFile</i> differ from those of the directory in <i>expectedPath</i> . Directory comparisons are performed on recursive snapshots of both directories.
<code>assertEqualFiles(   expectedPath : String,   obtainedPath : String)</code>	Fails the test if the contents of the file in <i>obtainedPath</i> differ from those of the file in <i>expectedPath</i> . File comparisons are performed on snapshots of both files.
<code>assertEqualModels(   [msg : String,]   expectedModel : String,   obtainedModel : String   [, options : Map])</code>	Fails the test with the optional message <i>msg</i> if the model named <i>obtainedModel</i> is not equal to the model named <i>expectedModel</i> . Model comparisons are performed on snapshots of the resource sets of both models. During EMF comparisons, XMI identifiers are ignored. Additional comparator-specific options can be specified through <i>options</i> .
<code>assertEquals(   [msg : String,]   expected : Any,   obtained : Any)</code>	Fails the test with the optional message <i>msg</i> if the values of <i>expected</i> and <i>obtained</i> are not equal.
<code>assertEquals(   [msg : String,]   expected : Real,   obtained : Real,   ulps : Integer)</code>	Fails the test with the optional message <i>msg</i> if the values of <i>expected</i> and <i>obtained</i> differ in more than <i>ulps</i> units of least precision. See <a href="#">this site</a> for details.
<code>assertError(expr : Any)</code>	Fails the test if no exception is thrown during the evaluation of <i>expr</i> .
<code>assertFalse(   [msg : String,]   cond : Boolean)</code>	Fails the test with the optional message <i>msg</i> if <i>cond</i> is <code>true</code> . It is a negated version of <code>assertTrue</code> .

assertLineWithMatch( [msg : String,] path : String, regexp : String)	Fails the test with the optional message <i>msg</i> if the file at <i>path</i> does not have a line containing a substring matching the regular expression <i>regexp</i> <sup>2</sup> .
assertMatchingLine( [msg : String,] path : String, regexp : String)	Fails the test with the optional message <i>msg</i> if the file at <i>path</i> does not have a line that matches the regular expression <i>regexp</i> <sup>3</sup> from start to finish.
assertNotEqualDirectories( expectedPath : String, obtainedPath : String)	Negated version of assertEqualsDirectories.
assertNotEqualFiles( expectedPath : String, obtainedPath : String)	Negated version of assertEqualsFiles.
assertNotEqualModels( [msg : String,] expectedModel : String, obtainedModel : String)	Negated version of assertNotEqualModels.
assertNotEquals( [msg : String,] expected : Any, obtained : Any)	Negated version of assertEquals([msg : String,] expected : Any, obtained : Any).
assertNotEquals( [msg : String,] expected : Real, obtained : Real, ulps : Integer)	Negated version of assertEquals([msg : String,] expected : Real, obtained : Real, ulps : Integer).
assertTrue( [msg : String,] cond : Boolean)	Fails the test with the optional message <i>msg</i> if <i>cond</i> is <i>false</i> .
fail(msg : String)	Fails a test with the message <i>msg</i> .

<sup>2</sup>See `JAVA.UUTIL.REGEX.PATTERN` for details about the accepted syntax for regular expressions.

<sup>3</sup>See footnote for `assertLineWithMatch` for details about the syntax of the regular expressions.

Table 15.3: Available options by model comparator

Comparator and key	Usage
EMF, “whitespace”	When set to “ignore”, differences in EString attribute values due to whitespace will be ignored. Disabled by default.
EMF, “ignoreAttributeValueChanges”	Can contain a Sequence of strings of the form “package.class.attribute”. Differences in the values for these attributes will be ignored. However, if the attribute is set on one side and not on the other, the difference will be reported as normal. Empty by default.
EMF, “unorderedMoves”	When set to “ignore”, differences in the order of the elements within an unordered EReference. Enabled by default.

More importantly, EUnit implements specific assertions for comparing models, files and trees of files. Model comparison is not implemented by the assertions themselves: it is an optional service implemented by some EMC drivers. Currently, EMF models will automatically use EMF Compare as their comparison engine. The rest of the EMC drivers do not support comparison yet. The main advantage of having an abstraction layer implement model comparison as a service is that the test case definition is decoupled from the concrete model comparison engine used.

Model, file and directory comparisons take a snapshot of their operands before comparing them, so EUnit can show the differences right at the moment when the comparison was performed. This is especially important when some of the models are generated on the fly by the EUnit test suite, or when a test case for code generation may overwrite the results of the previous one.

Figure 15.3 shows a screenshot of the EUnit graphical user interface. On the left, an Eclipse view shows the results of several EUnit test suites. We can see that the `load-models-with-hutn` suite failed. The Compare button to the right of “Failure Trace” can be pressed to show the differences between the expected and obtained models, as shown on the right side. EUnit implements a pluggable architecture where *difference viewers* are automatically selected based on the types of the operands. There are difference viewers for EMF models, file trees and a fallback viewer which converts both operands to strings.

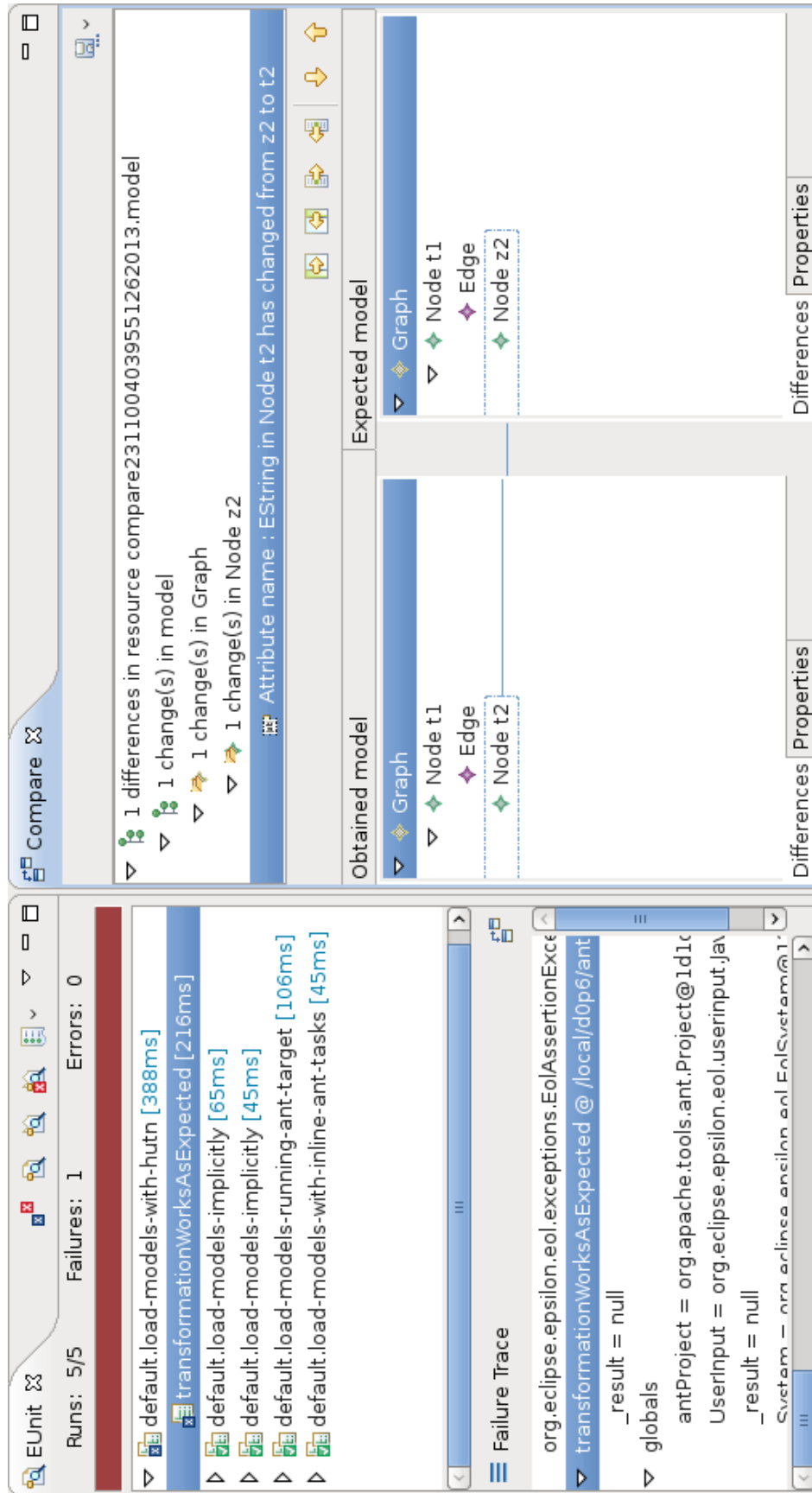

Figure 15.3: Screenshot of the EUnit graphical user interface

## 15.4 Examples

### 15.4.1 Models and Tasks in the Buildfile

After describing the basic syntax, we will show how to use EUnit to test an ETL transformation.

The Ant buildfile is shown in Listing 15.5. It has two targets: *run-tests* (lines 2–19) invokes the EUnit suite, and *tree2graph* (lines 23–28) is a helper target which transforms model “Tree” into model “Graph” using ETL. The `<modelTasks>` nested element is used to load the input, expected output and output EMF models. “Graph” is loaded with *read* set to *false*: the model will be initially empty, and will be populated by the ETL transformation.

```
1 <project>
2   <target name="run-tests">
3     <epsilon.eunit src="test-external.eunit">
4       <modelTasks>
5         <epsilon.emf.loadModel name="Tree"
6           modelfile="tree.model"
7           metamodelfile="tree.ecore"
8           read="true" store="false"/>
9         <epsilon.emf.loadModel name="GraphExpected"
10          modelfile="graph.model"
11          metamodelfile="graph.ecore"
12          read="true" store="false"/>
13        <epsilon.emf.loadModel name="Graph"
14          modelfile="transformed.model"
15          metamodelfile="graph.ecore"
16          read="false" store="false"/>
17      </modelTasks>
18    </epsilon.eunit>
19  </target>
20  <target name="tree2graph">
21    <epsilon.etl src="{basedir}/resources/Tree2Graph.etl">
22      <model ref="Tree"/>
23      <model ref="Graph"/>
24    </epsilon.etl>
25  </target>
26 </project>
```

Listing 15.5: Ant buildfile for EUnit with `<modelTasks>` and a helper target

The EOL script is shown in Listing 15.6: it invokes the helper task (line 3) and checks that the obtained model is equal to the expected model (line 4). Internally, EMC will



perform the comparison using EMF Compare.

```
1 @test
2 operation transformationWorksAsExpected() {
3     runTarget("tree2graph");
4     assertEquals("GraphExpected", "Graph");
5 }
```

Listing 15.6: EOL script using `runTarget` to run ETL

## 15.4.2 Models and Tasks in the EOL Script

In the previous section, the EOL file is kept very concise because the model setup and model management tasks under test were specified in the Ant buildfile. In this section, we will inline the models and the tasks into the EOL script instead.

The Ant buildfile is shown in Listing 15.7. It is now very simple: all it needs to do is run the EOL script. However, since we will parse HUTN in the EOL script, we must make sure the EPACKAGES of the metamodels are registered.

```
1 <project>
2   <target name="run-tests">
3     <epsilon.emf.register file="tree.ecore"/>
4     <epsilon.emf.register file="graph.ecore"/>
5     <epsilon.eunit src="test-inlined.eunit"/>
6   </target>
7 </project>
```

Listing 15.7: Ant buildfile which only runs the EOL script

The EOL script used is shown in Listing 15.8. Instead of loading models through the Ant tasks, the `loadHutn` operation has been used to load the models. The test itself is almost the same, but instead of running a helper target, it invokes an operation which creates and runs the ETL Ant task through the `antProject` variable provided by EUnit, taking advantage of the support in EOL for invoking Java code through reflection.

```
1 @model
2 operation loadModels() {
3     loadHutn("Tree", '@Spec {Metamodel {nsUri: "Tree" }}
4 Model {
5     Tree "t1" { label : "t1" }
6     Tree "t2" {
7         label : "t2"
8         parent : Tree "t1"
9     }
```

```

10 }
11 ');
12
13 loadHutn("GraphExpected", '@Spec {Metamodel {nsUri: "Graph"}}
14 Graph { nodes :
15   Node "t1" {
16     name : "t1"
17     outgoing : Edge { source : Node "t1" target : Node "t2" }
18   },
19   Node "t2" {
20     name : "t2"
21   }
22 }
23 ');
24
25 loadHutn("Graph", '@Spec {Metamodel {nsUri: "Graph"}}');
26 }
27
28 @test
29 operation transformationWorksAsExpected() {
30   runETL();
31   assertEquals("GraphExpected", "Graph");
32 }
33
34 operation runETL() {
35   var etlTask := antProject.createTask("epsilon.etl");
36   etlTask.setSrc(new Native(' java.io.File')(
37     antProject.getBaseDir(), 'resources/etl/Tree2Graph.etl'));
38   etlTask.createModel().setRef("Tree");
39   etlTask.createModel().setRef("Graph");
40   etlTask.execute();
41 }

```

Listing 15.8: EOL script with inlined models and tasks

## 15.5 Extending EUnit

EUnit is based on the Epsilon platform, but it is designed to accommodate other technologies. In this section we will explain several strategies to add support for these technologies to EUnit.

EUnit uses the Epsilon Model Connectivity abstraction layer to handle different modelling technologies. Adding support for a different modelling technology only requires

implementing another driver for EMC. Depending on the modelling technology, the driver can provide optional services such as model comparison, caching or reflection. For more details, the reader is suggested to consult Chapter 2.

EUnit uses Ant as a workflow language: all model management tasks must be exposed through Ant tasks. It is highly encouraged, however, that the Ant task is aware of the EMC model repository linked to the Ant project. Otherwise, users will have to shuffle the models out from and back into the repository between model management tasks. As an example, a helper target for an ATL [6] transformation with the existing Ant tasks needs to:

1. Save the input model in the EMC model repository to a file, by invoking the `<epsilon.storeModel>` task.
2. Load the metamodels and the input model with `<atl.loadModel>`.
3. Run the ATL transformation with `<atl.launch>`.
4. Save the result of the ATL transformation with `<atl.saveModel>`.
5. Load it into the EMC model repository with `<epsilon.emf.loadModel>`.

Listing 15.9 shows the Ant buildfile which would be required for running these steps, showing that while EUnit can use the existing ATL tasks as-is, the required helper task is quite longer than the one in Listing 15.5. Ideally, Ant tasks should be adapted or wrapped to use models directly from the EMC model repository.

```
1 <project>
2 <!-- ... omitted ... -->
3 <target name="atl">
4   <!-- Create temporary files for input and output models -->
5   <tempfile property="atl.temp.srcfile" />
6   <tempfile property="atl.temp.dstfile" />
7
8   <!-- Save input model to a file -->
9   <epsilon.storeModel model="Tree"
10     target="${atl.temp.srcfile}" />
11
12   <!-- Load the metamodels and the source model -->
13   <atl.loadModel name="TreeMM" metamodel="MOF"
14     path="metamodels/tree.ecore" />
15   <atl.loadModel name="GraphMM" metamodel="MOF"
16     path="metamodels/graph.ecore" />
```

```

17 <atl.loadModel name="Tree" metamodel="TreeMM"
18   path="\${atl.temp.srcfile}" />
19
20 <!-- Run ATL and save the model -->
21 <atl.launch path="transformation/tree2graph.atl">
22   <inmodel name="IN" model="Tree" />
23   <outmodel name="OUT" model="Graph" metamodel="GraphMM" />
24 </atl.launch>
25 <atl.saveModel model="Graph" path="\${atl.temp.dstfile}" />
26
27 <!-- Load it back into the EUnit suite -->
28 <epsilon.emf.loadModel name="Graph"
29   modelfile="\${atl.temp.dstfile}"
30   metamodeluri="Graph"
31   read="true" store="false" />
32
33 <!-- Delete temporary files -->
34 <delete file="\${atl.temp.srcfile}" />
35 <delete file="\${atl.temp.dstfile}" />
36 </target>
37 </project>

```

Listing 15.9: Testing an ATL model transformation with EUnit

Another advantage in making model management tasks EMC-aware is that they can easily “export” their results as models, making them easier to test. For instance, the EVL Ant task allows for exporting its results as a model by setting the attribute *exportAsModel* to `true`, as mentioned in Section 14.5.2. This way, EOL can query the results as any regular model (see Listing 15.10). This is simpler than transforming the validated model to a problem metamodel, as suggested in [53]. The example in Listing 15.10 checks that a single warning was produced due to the expected rule (`LabelsStartWithT`) and the expected model element.

```

1 @test
2 operation valid() {
3   var tree := new Tree!Tree;
4   tree.label := '1n';
5   runTarget('validate-tree');
6   var errors := EVL!EvlUnsatisfiedConstraint.allInstances;
7   assertEquals(1, errors.size);
8   var error := errors.first;
9   assertEquals(tree, error.instance);
10  assertEquals(false, error.constraint.isCritique);
11  assertEquals('LabelsStartWithT', error.constraint.name);

```

Listing 15.10: Testing an EVL model validation with EUnit

## 15.6 Summary

This chapter has presented EUnit, an unit testing framework specialized on testing model management tasks, such as model-to-model transformations, model-to-text transformations and model validations. Section 15.1 has presented the motivation for creating EUnit. Section 15.2 has described the data model used by EUnit, and the steps involved in running a test. Section 15.3 has specified how tests in EUnit are written. Section 15.4 has shown two examples that test the same ETL transformation using different EUnit constructs. Finally, Section 15.5 suggests how to extend EUnit to handle additional modelling and model management technologies.



# Bibliography

- [1] Object Management Group. UML 2.0 OCL Specification. <http://www.omg.org/docs/ptc/03-10-14.pdf>.
- [2] Craig Larman. *Applying UML and Patterns : An Introduction to Object-Oriented Analysis and Design and Iterative Development*. Prentice Hall PTR, 3rd edition, October 2004.
- [3] B. Meyer. *Object-Oriented Software Construction*. Prentice-Hall, 2 edition, 1997.
- [4] Dimitrios S. Kolovos, Richard F. Paige and Fiona A.C. Polack. On the Evolution of OCL for Capturing Structural Constraints in Modelling Languages. In *Proc. Dagstuhl Workshop on Rigorous Methods for Software Construction and Analysis*, 2008.
- [5] Dimitrios S. Kolovos, Richard F. Paige and Fiona A.C. Polack. The Epsilon Transformation Language. In *Proc. 1st International Conference on Model Transformation*, Zurich, Switzerland, July 2008.
- [6] Frédéric Jouault and Ivan Kurtev. Transforming Models with the ATL. In Jean-Michel Bruel, editor, *Proceedings of the Model Transformations in Practice Workshop at MoDELS 2005*, volume 3844 of LNCS, pages 128–138, Montego Bay, Jamaica, October 2005.
- [7] Object Management Group. MOF QVT Final Adopted Specification. <http://www.omg.org/cgi-bin/doc?ptc/05-11-01.pdf>.
- [8] Krzysztof Czarnecki and Simon Helsen. Classification of Model Transformation Approaches. In *OOPSLA '03 Workshop on Generative Techniques in the Context of Model-Driven Architecture*, 2003.
- [9] Jack Herrington. *Code Generation in Action*. Manning, 2003. ISBN: 1930110979.

- [10] Dimitrios S. Kolovos, Richard F. Paige and Fiona A.C. Polack. The Epsilon Object Language. In *Proc. European Conference in Model Driven Architecture (EC-MDA) 2006*, volume 4066 of *LNCS*, pages 128–142, Bilbao, Spain, July 2006.
- [11] George A. Miller. WordNet: a lexical database for English. *Communications of ACM*, 38(11):39–41, 1995.
- [12] G. Navarro. A guided tour to approximate string matching. *ACM Computing Surveys (CSUR)*, 33(1):31–88, 2001.
- [13] SimMetrics Similarity Metrics Library. <http://www.dcs.shef.ac.uk/~sam/simmetrics.html>.
- [14] V. I. Levenshtein. Binary codes capable of correcting deletions, insertions, and reversals. *Soviet Physics Doklady*, 10:707–710, 1966.
- [15] Object Management Group, Jishnu Mukerji, Joaquin Miller. MDA Guide version 1.0.1, 2001. <http://www.omg.org/cgi-bin/doc?omg/03-06-01.pdf>.
- [16] Rachel A. Pottinger and Philip A. Bernstein. Merging Models Based on Given Correspondences. Technical Report UW-CSE-03-02-03, University of Washington, 2003. Technical report.
- [17] C. Batini, M. Lenzerini, S.B. Navathe. A Comparative Analysis of Methodologies for Database Schema Integration. *ACM Computing Surveys*, 18(4):323–364, December 1986.
- [18] Kim Letkeman. Comparing and merging UML models in IBM Rational Software Architect. IBM Developerworks, July 2005. [http://www-128.ibm.com/developerworks/rational/library/05/712\\_comp](http://www-128.ibm.com/developerworks/rational/library/05/712_comp).
- [19] S. Melnik, E. Rahm and P. A. Bernstein. Rondo: A Programming Platform for Generic Model Management. In *Proc. SIGMOD*, pages 193–204, 2003.
- [20] J. Sprinkle. *Metamodel Driven Model Migration*. PhD thesis, Vanderbilt University, TN, USA, 2003.
- [21] M. Herrmannsdoerfer, S. Benz, and E. Juergens. Automatability of coupled evolution of metamodels and models in practice. In K. Czarnecki, I. Ober, J. Bruel, A. Uhl, and M. Völter, editors, *Proc. International Conference on Model Driven Engineering Languages and Systems (MoDELS)*, volume 5301 of *Lecture Notes in Computer Science*, pages 645–659. Springer, 2008.



- [22] L.M. Rose, D.S. Kolovos, R.F. Paige, and F.A.C. Polack. Epsilon Flock: A model migration language. *Software and Systems Modeling [accepted and to appear]*, 2012.
- [23] L.M. Rose. *Structures and Processes for Managing Model-Metamodel Co-evolution*. PhD thesis, University of York, United Kingdom, 2011.
- [24] L.M. Rose, M. Herrmannsdoerfer, J.R. Williams, D.S. Kolovos, K. Garcés, R.F. Paige, and F.A.C. Polack. A comparison of model migration tools. In D.C. Petriu, N. Rouquette, and Ø. Haugen, editors, *Proc. International Conference on Model Driven Engineering Languages and Systems (MoDELS), Part I*, volume 6394 of *Lecture Notes in Computer Science*, pages 61–75. Springer, 2010.
- [25] Taentzer, Gabriele. AGG: A Graph Transformation Environment for Modeling and Validation of Software. In Pfaltz, John and Nagl, Manfred and Böhlen, Boris, editor, *Applications of Graph Transformations with Industrial Relevance*, volume 3062 of *Lecture Notes in Computer Science*, pages 446–453. Springer Berlin / Heidelberg, 2004.
- [26] Biermann, Enrico and Ermel, Claudia and Taentzer, Gabriele. Precise Semantics of EMF Model Transformations by Graph Transformation. In *Proceedings of the 11th international conference on Model Driven Engineering Languages and Systems, MoDELS '08*, pages 53–67, Berlin, Heidelberg, 2008. Springer-Verlag.
- [27] Edgar Jakumeit, Sebastian Buchwald, Moritz Kroll. GrGen.NET. *International Journal on Software Tools for Technology Transfer (STTT)*, 12(3):263–271, July 2010.
- [28] Andras Balogh, Daniel Varro. Advanced model transformation language constructs in the VIATRA2 framework. In *SAC '06: Proceedings of the 2006 ACM symposium on Applied computing*, pages 1280–1287, New York, NY, USA, 2006. ACM Press.
- [29] Bergmann, Gábor and Ujhelyi, Zoltán and Ráth, István and Varró, Dániel. A graph query language for EMF models. In *Proceedings of the 4th international conference on Theory and practice of model transformations, ICMT'11*, pages 167–182, Berlin, Heidelberg, 2011. Springer-Verlag.
- [30] Maged Elaasar, Lionel C. Briand, and Yvan Labicic. An Approach to Detecting Design Patterns in MOF-Based Domain-Specific Models with QVT. Technical Report TR-SCE-10-02, Carleton University, 2010. [http://squall.sce.carleton.ca/pubs/tech\\_report/TR-SCE-10-02.pdf](http://squall.sce.carleton.ca/pubs/tech_report/TR-SCE-10-02.pdf).

- [31] Richard F. Paige and Dimitrios S. Kolovos and Louis M. Rose and Nicholas Drivalos and Fiona A.C. Polack. The Design of a Conceptual Framework and Technical Infrastructure for Model Management Language Engineering. *IEEE International Conference on Engineering of Complex Computer Systems*, 0:162–171, 2009.
- [32] Benoit Baudry, Sudipto Ghosh, Franck Fleurey, Robert France, Yves Le Traon, and Jean-Marie Mottu. Barriers to systematic model transformation testing. *Communications of the ACM*, 53:139–143, June 2010.
- [33] A. Ferdjoukh, A. Baert, E. Bourreau, A. Chateau, R. Coletta, and C. Nebut. Instantiation of Meta-models Constrained with OCL - A CSP Approach. pages 213–222. SCITEPRESS, 2015.
- [34] Dimitrios S. Kolovos, Richard F. Paige, Louis M. Rose, Fiona A.C. Polack. Unit Testing Model Management Operations. In *Proc. 5th Workshop on Model Driven Engineering Verification and Validation (MoDeVVA), IEEE ICST, Lillehammer, Norway, April 2008*.
- [35] The Apache Ant Project. <http://ant.apache.org>.
- [36] Steve Holzner. *Ant: The Definitive Guide, Second Edition*. O’Reilly, April 2005. ISBN 0-596-00609-8.
- [37] GNU Make, Official Web-Site. <http://www.gnu.org/software/make/>.
- [38] Apache Maven Project. <http://maven.apache.org>.
- [39] Julien Dubois. Master and Commander. Mastering J2EE Application Development Series. <http://www.oracle.com/technology/pub/articles/masterj2ee/files/j2ee2.pdf>.
- [40] ANT External Tools and Tasks. <http://ant.apache.org/external.html>.
- [41] Atlas Model Management Architecture. <http://www.sciences.univ-nantes.fr/lina/atl/AMMAROOT/>.
- [42] Frédéric Jouault, Jean Bézivin, and Ivan Kurtev. TCS: a DSL for the Specification of Textual Concrete Syntaxes in Model Engineering. In *Proc GPCE’06: Proceedings of the fifth international conference on Generative programming and Component Engineering*, pages 249–254, 2006.
- [43] Michael Guttman and John Parodi. *Real-Life MDA: Solving Business Problems with Model Driven Architecture*. Morgan Kaufmann, first edition, December 2006.

- [44] Ragnhild Straeten, Tom Mens, and Stefan Baelen. Challenges in Model-Driven software engineering. In Michel R. V. Chaudron, editor, *Models in Software Engineering*, volume 5421 of *LNCS*, pages 35–47. Springer-Verlag, Berlin, Germany, 2009.
- [45] Jean-Marie Mottu, Benoit Baudry, and Yves Le Traon. Model transformation testing: oracle issue. In *Proc. of the 2008 IEEE Int. Conf. on Software Testing Verification and Validation*, pages 105–112, Lillehammer, Norway, April 2008.
- [46] Dave Steinberg, Frank Budinsky, Marcelo Paternostro, and Ed Merks. *EMF: Eclipse Modeling Framework*. Addison-Wesley Professional, second edition, December 2008.
- [47] openArchitectureWare MDSO platform, Official Web-Site. <http://www.openarchitectureware.org/>.
- [48] Kent Beck. JUnit.org, April 2011.
- [49] David Saff. Theory-infected: or how I learned to stop worrying and love universal quantification. In *Companion to the 22nd ACM SIGPLAN Conf. on Object-oriented Programming Systems and Applications*, OOPSLA '07, pages 846–847, New York, NY, USA, 2007. ACM.
- [50] Object Management Group. Human-Usable Textual Notation v1.0, 2004. <http://www.omg.org/cgi-bin/doc?formal/2004-08-01>.
- [51] Cédric Beust. TestNG, March 2011.
- [52] Kohsuke Kawaguchi. Jenkins CI, April 2011.
- [53] Frédéric Jouault, Jean Bezivin. Using ATL for Checking Models. In *Proc. International Workshop on Graph and Model Transformation (GraMoT)*, Tallinn, Estonia, September 2005.