

Logistics Specification and Analysis Tool (Eclipse LSAT™) Design Documentation

Version nightly

Table of Contents

1. Introduction	2
1.1. Scope	2
1.2. Tools	2
2. Architecture	3
2.1. Domain Languages	3
2.1.1. Machine	3
2.1.2. Settings	7
2.1.3. Activities	10
2.1.4. Logistics	12
2.2. Analysis Languages	13
2.2.1. DirectedGraph Metamodel	13
2.2.2. EditableDirectedGraph Metamodel	14
2.2.3. Scheduler Metamodel	15
2.2.4. PetriNet Metamodel	17
2.2.5. MaxPlus Metamodel	18
3. Workflows for aspect models	21
3.1. Scheduling activities including Gantt chart visualization	21
3.2. Optimal Makespan/Throughput Scheduling	22
3.2.1. Introduction	22
3.2.2. Workflow	23
3.3. Conformance Checking	24
4. Overview of Plugins	26
4.1. Machine	26
4.2. Settings	26
4.3. Activities	26
4.4. Logistics	27
4.5. Directed Graph	27
4.6. MaxPlus	27
4.7. Scheduling Activities including Gantt Chart Visualization	28
4.8. Conformance Checking	28
4.9. Throughput per Resource	29
4.10. Documentation	29
5. Developing	30
5.1. Development environment setup	30
5.2. Building with Maven	32
5.3. License header	33
5.4. Third party notice	33
Appendix A: How to implement your own custom motion profile	34

Create a new motion calculator	34
Test your new motion calculator	40
Appendix B: How to implement a custom motion calculator with Json	43
Terminology	43
Json Interface	44
Configuring the shared library	45
Json Schema for request and response	47
Examples of Json messages	51
Supported Profiles	51
Validate	51
Calculate Times	52
Position Info	53
Error Response	55
Background Eclipse LSAT™ Internal motion calculator API	56

This document explains the domain of the Logistics, Specification and Analysis Tool (Eclipse LSAT™), provides explanation to the underlying architecture of Eclipse LSAT™, and presents the workflows for different analysis techniques included in Eclipse LSAT™. This document is intended to assist stakeholders involved in the software development of Eclipse LSAT™, whether new or old, to understand the existing architecture of Eclipse LSAT™.

- [Section 1](#) is an introduction to Eclipse LSAT™ and its different performance analysis techniques.
- [Section 2](#) describes the architecture of Eclipse LSAT™.
- [Section 3](#) describes related workflows.
- [Section 4](#) gives an overview about different plugins in Eclipse LSAT™.
- [Section 5](#) provides information on development for Eclipse LSAT™.
- [Appendix A](#) provides information on how to add your own custom motion profile to Eclipse LSAT.
- [Appendix B](#) provides information on how to implement a custom motion calculator with Json.

Chapter 1. Introduction

1.1. Scope

Eclipse LSAT™ allows convenient modeling mechanism for physical machines. In addition to modeling of logistics, the following analysis techniques are also included in Eclipse LSAT™.

1. Automatic generation of optimal logistics in terms of makespan/throughput.
2. Visualization of logistics in the form of Gantt charts.
3. Conformance checking of traces against a specification.

Thus, Eclipse LSAT™ offers design-space exploration for the physical machine which enables engineers to predict performance at a design time.

1.2. Tools

The following tools are used for designing architecture and modeling environment of Eclipse LSAT™.

- Eclipse Modelling Framework (EMF) (<https://www.eclipse.org/modeling/emf/>)
- QVTo (<https://projects.eclipse.org/projects/modeling.mmt.qvt-oml>)
- Xtend (<https://www.eclipse.org/xtend/>)
- Xtext (<https://www.eclipse.org/Xtext/>)
- Sirius (<https://www.eclipse.org/sirius/>)
- Eclipse Layout Kernel (<https://www.eclipse.org/elk/>)

The following tools are used for performance analysis.

- Eclipse ESCET (Supervisory Control Engineering Toolkit) (<https://www.eclipse.org/escet>)
- Eclipse TRACE4CPS (<https://www.eclipse.org/trace4cps>)

Chapter 2. Architecture

This section presents the architecture used to design and analyze logistics in Eclipse LSAT™. In the first subsection, we explain the domain languages of Eclipse LSAT™. In addition to domain languages, we also have analysis languages to perform performance analyses which are explained in the second subsection.

2.1. Domain Languages

Logistics in Eclipse LSAT™ are modeled by separating different concerns in a modular way, as shown in the following figure. Typically, persistence of each domain language is implemented in Xtext. For graphical editing, Sirius representation is implemented.

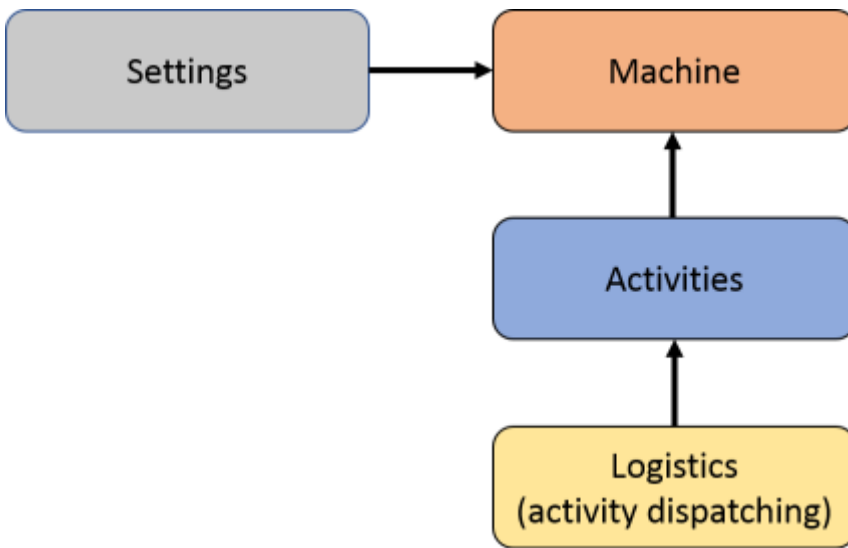

2.1.1. Machine

This module describes the plant in terms of *resources* and *peripherals* with their capabilities and restrictions. For example, machine corresponds to the plant or a part of the plant. Similarly robot and its clamp correspond to resource and peripheral respectively. Thus, we describe the plant on a logical level using the machine module.

We express motion in robots by using symbolic coordinates and physical coordinates to decouple physical implementation from logical specification. For example, for representing symbolic coordinates, the cylindrical coordinate system is used. Whereas, the angular coordinate system is used to represent physical coordinates. The cylindrical system is shown in the figure below.

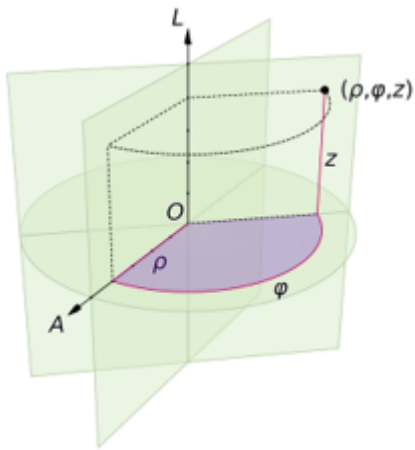

Figure 1. Cylindrical Coordinate System

The cylindrical coordinate system contains origin O, polar axis A, and longitudinal axis L. The dot is a point with radial distance ρ (R), angular coordinate ϕ (Phi), and height z.

A robot in angular coordinate system is shown in the figure below. In this figure, the robot is present at the cylindrical coordinate with angular coordinates Θ_1 (Th1) and Θ_2 (Th2) and height z.



Figure 2. Angular Coordinate System

The angular coordinates can be calculated from cylindrical coordinates as follows.

$$\Theta_1 = \Phi - \arccos((R - E)/2/L)$$

$$\Theta_2 = \Phi + \arccos((R - E)/2/L)$$

Machine Metamodel

The machine metamodel is shown in the figure below. Within industrial context, a machine model instance typically represents a physical machine.

by *PathTargetReference* that refers to a symbolic position. *settling* defines the settling axes on paths.

For all axes of a movable peripheral, we have to define positions. For example, in the following figure, we can see positions for X and Y axes.

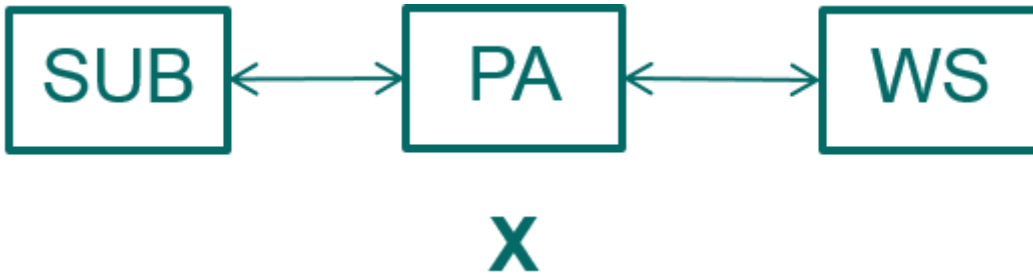

Figure 4. Positions for X axis

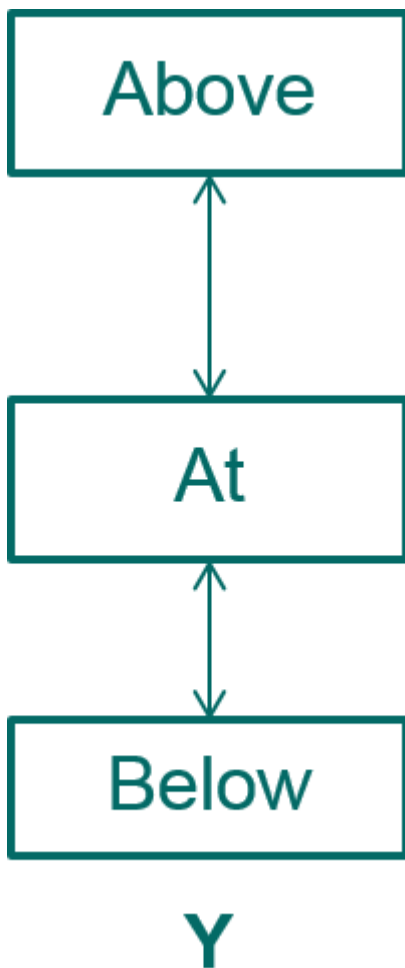

Figure 5. Positions for Y axis

To define positions for an axis, we define a key-value pair *AxisPositionsMapEntry* in the machine metamodel, where key is an *axis* and values are *positions* (similar to *AxisPositionsMapEntry*).

The machine metamodel contains some operations, as explained in the following.

Name	Class	Description
getPosition(axis Axis)	SymbolicPosition	Returns position of the axis for this specific symbolic position.

Name	Class	Description
getOutgoingPaths()	SymbolicPosition	Returns the list of outgoing paths from a symbolic position.
getSources()	Path	Returns the source of a path.
getTargets()	Path	Returns the target of a path.

Motion specified as distances

Instead of positions, distances can be specified. Distances only describe a move of a certain distance where the location is unknown or not relevant. Typically used for circular, belt or mill movements. Either (**AxisPositions,SymbolicPositions,Paths**) or **Distances** must be specified. They are mutual exclusive.

Resource items

If multiple instances of the same Resource exist then *ResourceItem(s)* can be used. The goal of *ResourceItem(s)* is to compact the model for equivalent *Resources*. If required settings may differ for the *Peripherals* of a *ResourceItem*.

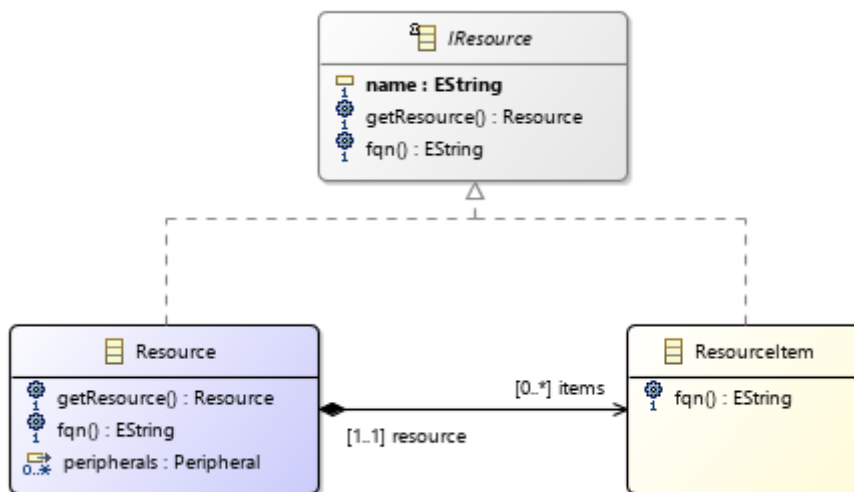

Figure 6. Resource items

2.1.2. Settings

This module provides physical settings for the machine. For example, for *peripherals*, we can specify the settings for physical locations and speed profiles.

Separating settings specification from machine specification allows us to have design-space exploration by analyzing the same machine for different physical settings.

Settings Metamodel

The settings metamodel is shown in the figure below. Using the setting metamodel, we can specify the physical settings for the Twinscan machine.

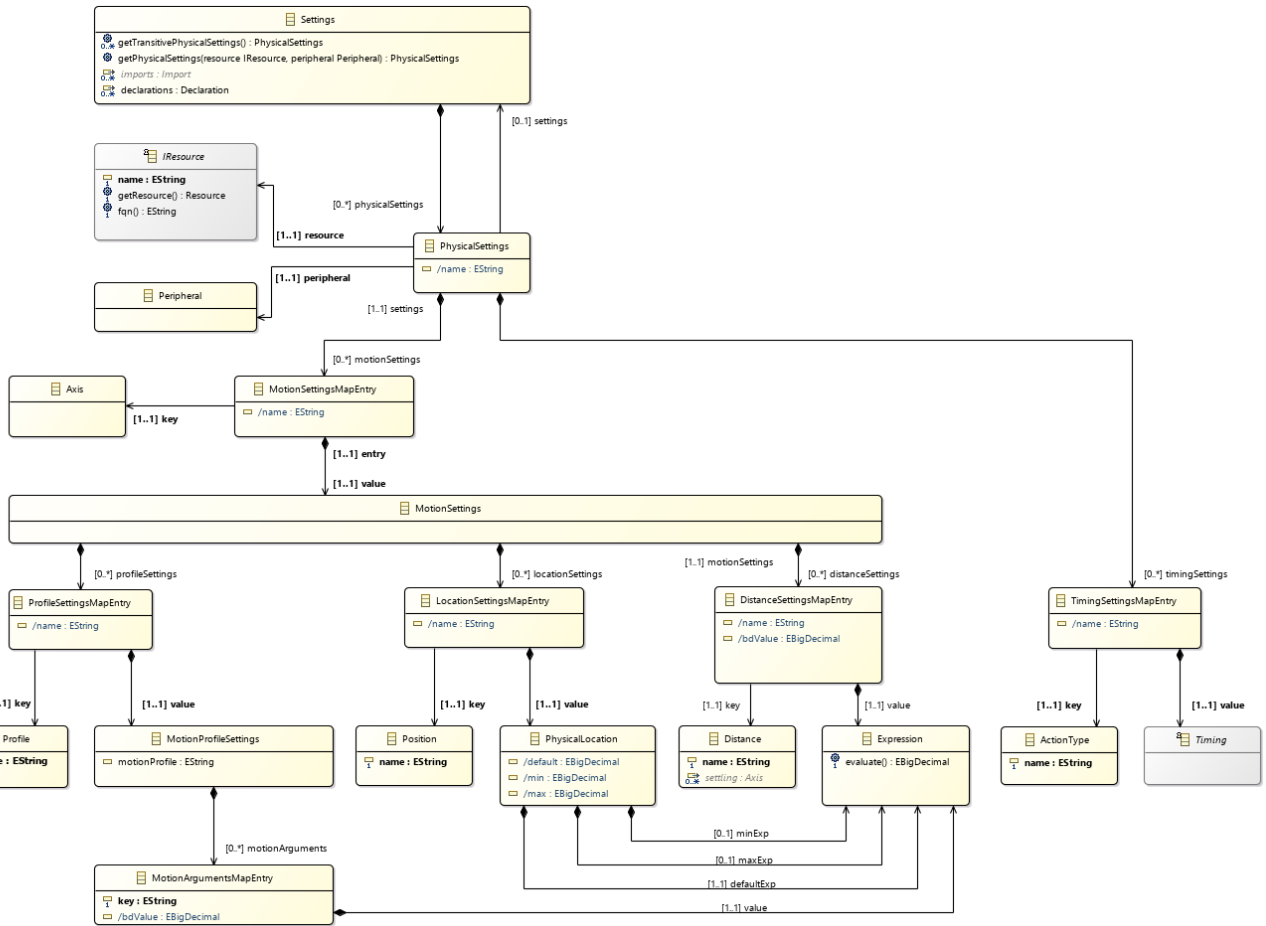

Figure 7. Settings Metamodel

Settings is the root of a model. It contains *PhysicalSettings* and *Import*. *PhysicalSettings* contains settings associated to a peripheral of a resource, and *Import* imports machine files containing the resources. In *PhysicalSettings*, we can,

1. set timing information for an action,
2. assign movement related parameters, i.e., motion parameters for a motion profile per axis,
3. allocate physical locations to symbolic positions per axis.
4. allocate physical distances to symbolic distances per axis.

For (1), *PhysicalSettings* contains *TimingSettingsMapEntry*. It is a key-value pair, where key is a *ActionType*, and value is *Timing*. Thus, we can assign timing for each action.

For (2), (3) and (4), *PhysicalSettings* contains *MotionSettingsMapEntry*, which is again a key-value pair. As (2), (3) and (4) are assigned for each axis, the key is *Axis*. The value is *MotionSettings*.

For (2), *MotionSettings* contains *ProfileSettingsMapEntry*, which is also a key-value pair. As we specify the movement related parameters per speed profile, the key is *Profile*. The value is *MotionProfileSettings* that defines the motion profile to use and contains a *MotionArgumentsMapEntry*, which is again a key-value pair of which the key is the motion profile parameter and the value is an *Expression* that defines the argument value.

For (3), *MotionSettings* contains *LocationSettingsMapEntry*, which is also a key-value pair. The key is *Position* and the value is an *Expression* that defines the physical location.

For (4), *MotionSettings* contains *DistanceSettingsMapEntry*, which is also a key-value pair. The key is *Distance* and the value is an *Expression* that defines the physical distance.

Expressions Metamodel

Expression is the interface to all expression types. ***Expression.evaluate()*** returns the evaluated result of the expression as *BigDecimal*

Supported expressions are:

1. *BinaryExpressions* : *Add*, *Multiply*, *Subtract* and *Divide*.
2. *DeclarationRef*: A Reference to a *Declaration*.
3. *BigDecimalConstant*: a constant value.

Expressions are used in *Settings* and *Timing MetaModel*

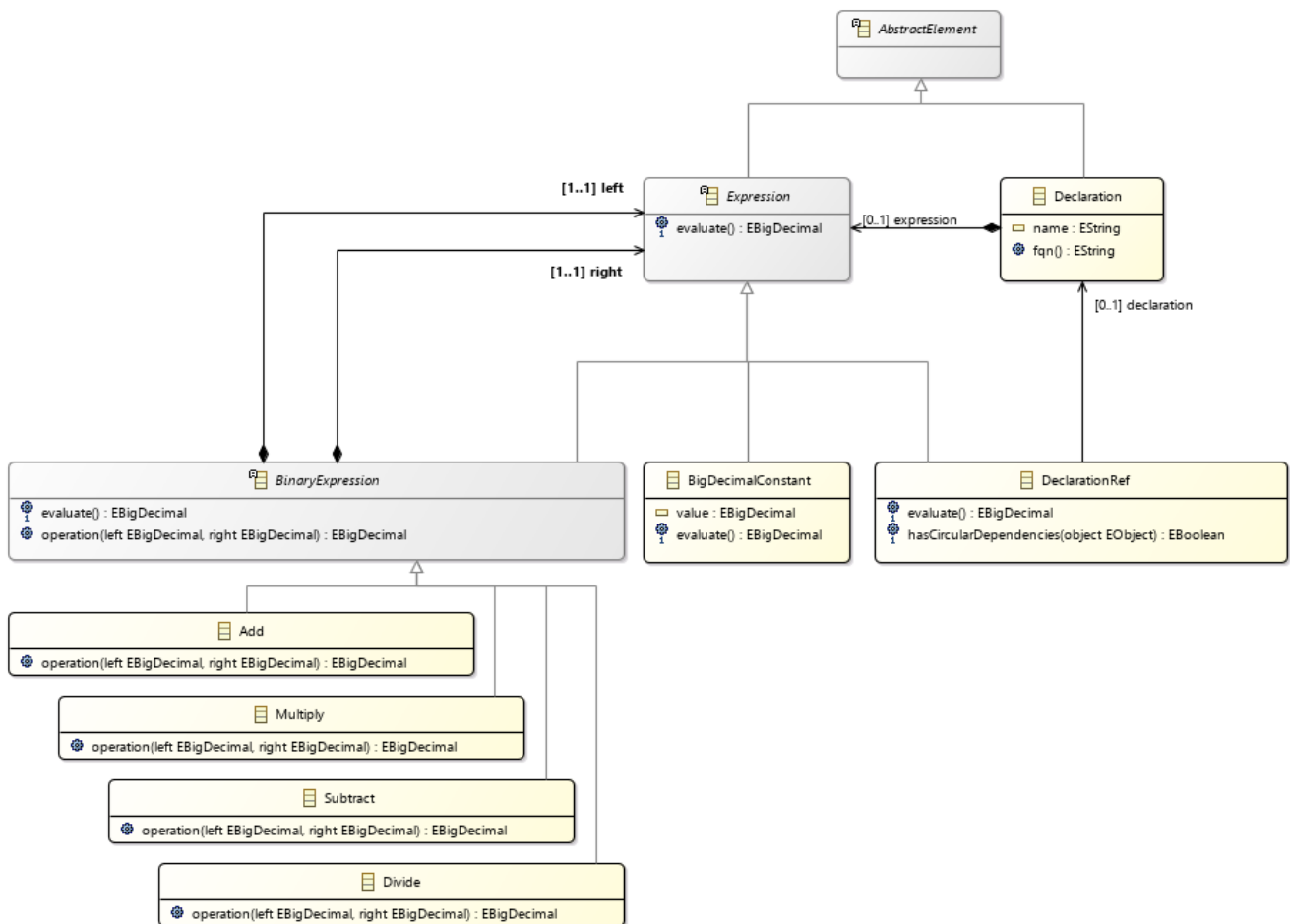

Figure 8. Expressions Metamodel



TODO: describe timing metamodels

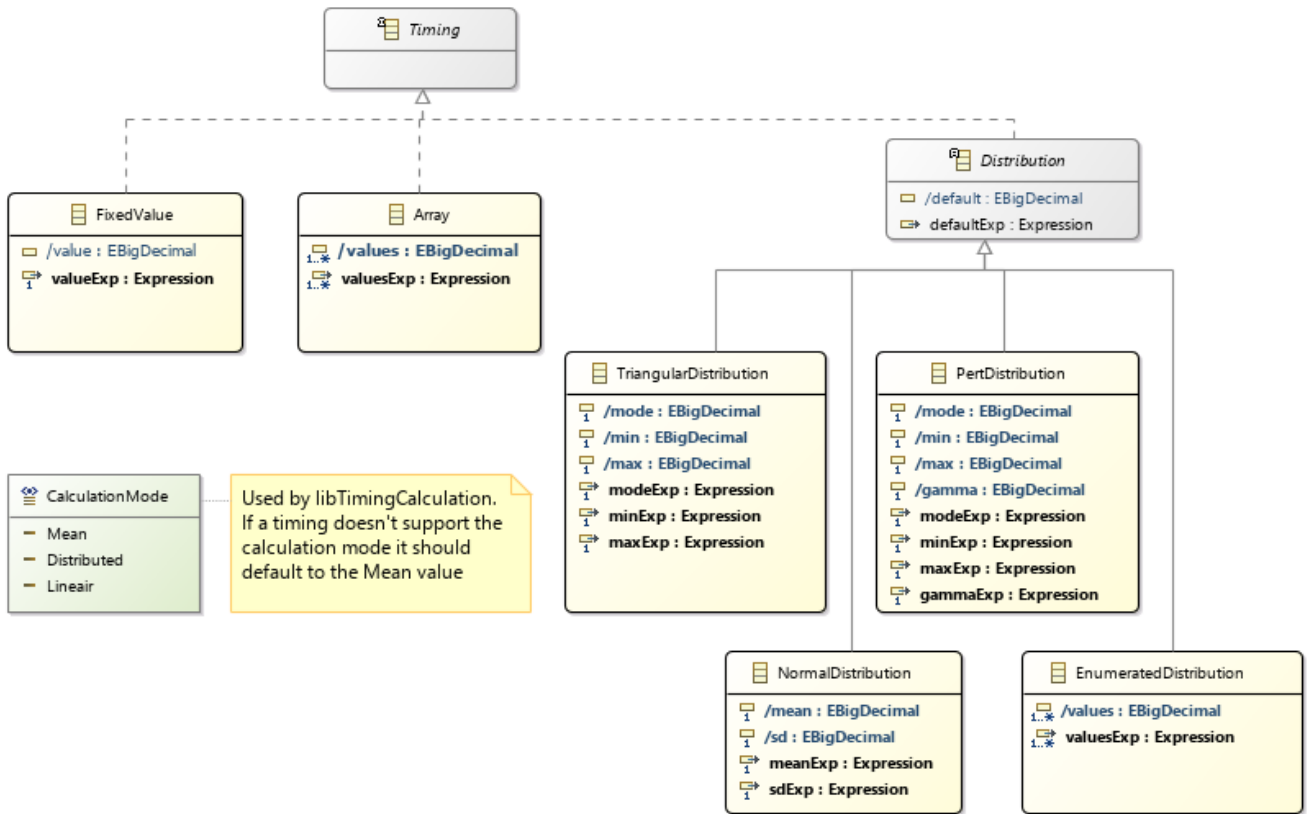

Figure 9. Timing Metamodel

2.1.3. Activities

Activity diagrams are graphical representations of workflows of stepwise activities and actions with support for choice, iteration and concurrency (see https://en.wikipedia.org/wiki/Activity_diagram). In the context of Eclipse LSAT™, the *Activities* module composes high level *actions* that a *resource* can perform into *activities*. For example, let us assume a robot capable of performing two actions *A1* and *A2*. The action *A1* specifies moving of the robot towards the pre-aligner (PA) position and the action *A2* specifies clamping of a product by the robot. We can compose these actions into an activity *toPAandClamp* in which the action *A1* is executed before the action *A2*.

It is also worth mentioning that Eclipse LSAT™ does not support all Activity diagram functions, e.g., iteration and choice.

Activity Metamodel

The activity metamodel is shown in the following figure. Using the activity metamodel, we can model *actions* that a *resource* can perform.

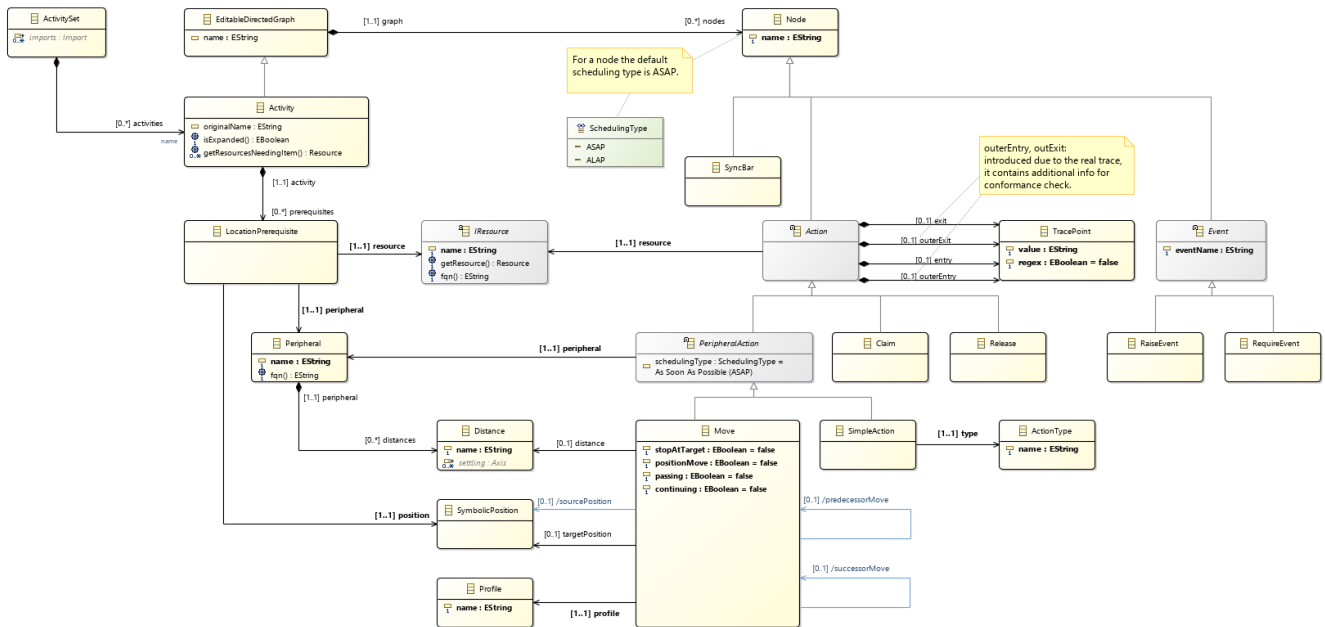

Figure 10. Activity Metamodel

ActivitySet is the root of a model. It contains *Activity* and *Import*. *Activity* represents the activities containing the actions a peripheral can perform. As activities have, in essence, a directed graph structure, *Activity* is a type of *EditableDirectedGraph* (see [EditableDirectedGraph Metamodel](#)).

EditableDirectedGraph contains *Node* representing the nodes in a graph. *Node* has three subtypes, i.e., *SyncBar*, *Action* and *Event*. *Actions* represents actions, *syncbars* are used to specify synchronization between actions and *events* can be used to specify synchronization across activities. *Action* contains *TracePoint* that is used for conformance checking of traces (see [Conformance Checking](#) subsection). As action is defined for a resource, *Action* has an association with *Resource*.

Action has three subtypes, explain as follows.

- *Claim* represents the claiming of a resource. Typically, claim is the start action in the activity diagram in which a resource is claimed and rest of the actions take place afterwards. In typical activity diagram workflows, the start action is shown as a black circle.
- *Release* represents the releasing of a resource. Typically, release is the final action in the activity diagram in which a resource is release after rest of the actions have taken place. In typical activity diagram workflows, the final action is shown as a encircled black circle.
- *PeripheralAction* represents the actions involving a peripheral. For example, clamping of a product by the peripheral clamp of a robot. Therefore, *PeripheralAction* has an association with *Peripheral*.

PeripheralAction are of two types, as explained in the following.

- *SimpleAction* represents simple actions like clamping or unclamping of a robot hand.
- *Move* represents the actions involving movements between *symbolic positions* or over *distances*.

Move has a boolean attribute *stopAtTarget*. If this attribute is true, then the peripheral does not perform any further movement and the current movement ends in stand-still. If this attribute is false, then another movement follows the current movement.

Activity also contains *LocationPrerequisite* that represents the initial location for all peripherals that move between positions for an activity.

2.1.4. Logistics

This module schedules activities specified in the activity module. For example, if we have two activities *toPAandClamp* and *Measure*, we can schedule these activities in such a way that the activity *toPAandClamp* is executed before the activity *Measure*.

Thus, we use the logistics module to specify the timing and throughput requirements.

Logistics Metamodel

The logistics metamodel is shown in the following figure. This metamodel is used to schedule activities modeled using [Activity Metamodel](#).

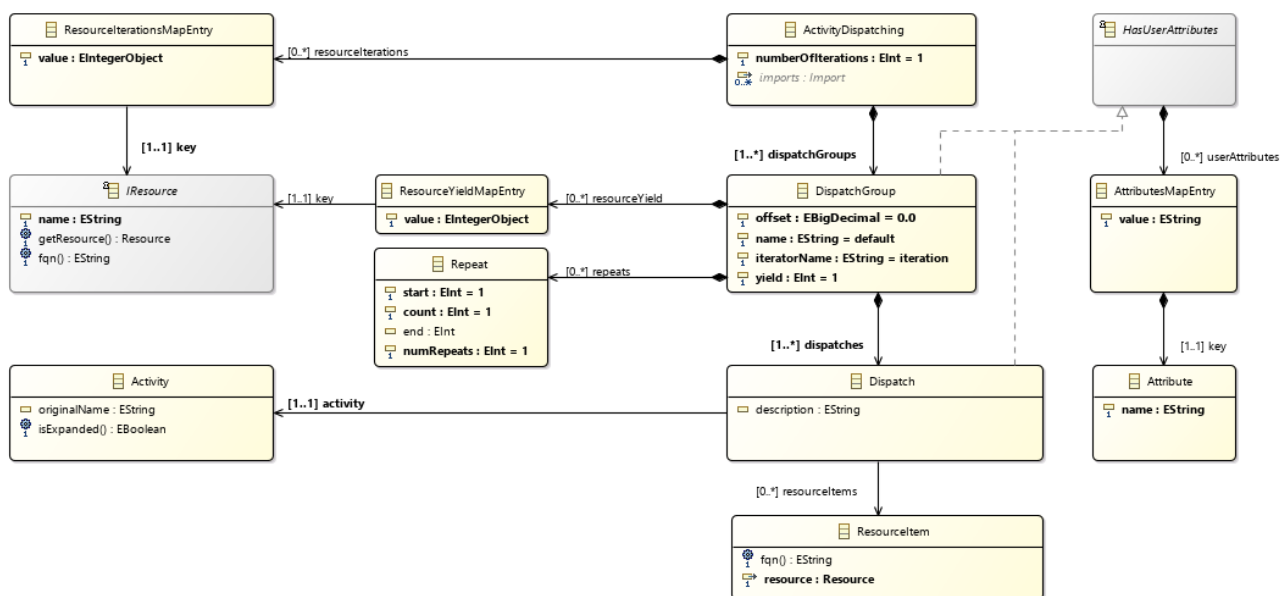

Figure 11. Logistics Metamodel

ActivityDispatching is the root of a model. It contains *DispatchGroup*, *ResourceIterationsMapEntry* and *Import*.

DispatchGroup:

- represents a group of activity dispatches.
- has an attribute *offset* that represents the offset time before the activities to start.
- has an attribute *yield* that describes the number of products **one** *Repeat* yields.
- has an attribute *iteratorName* that describes the name of the item that is dispatched. The default is 'iteration'.
- contains one or more *Dispatch* that represents dispatching of an activity. Therefore, *Dispatch*

has an association with *Activity*.

- contains a list of *Repeats*.

Repeat describes how often the activities in a *DispatchGroup* must be repeated. For flexible range support (similar to how pages are specified in a print command) *Repeat* contains a range (start, count, end, numberRepeats). To support multiple ranges multiple *Repeats* can be used in a *DispatchGroup*.

ResourceIterationsMapEntry is used to identify where the specification can be optimized for throughput performance of the system. *ResourceIterationsMapEntry* is also used to show an overview of the throughput per resource and the throughput of the total activity dispatching sequence. Thus, *ResourceIterationsMapEntry* is a key-value pair, where key is *Resource* representing the resource for which the throughput is calculated, and value is *EIntegerObject* representing the number of iterations.

HasUserAttributes supports a list of key-value pairs that can be added to a *DispatchGroup* or *Dispatch*. This way user specific metadata can be added to the model.

2.2. Analysis Languages

2.2.1. DirectedGraph Metamodel

The DirectedGraph metamodel is shown in the following figure.

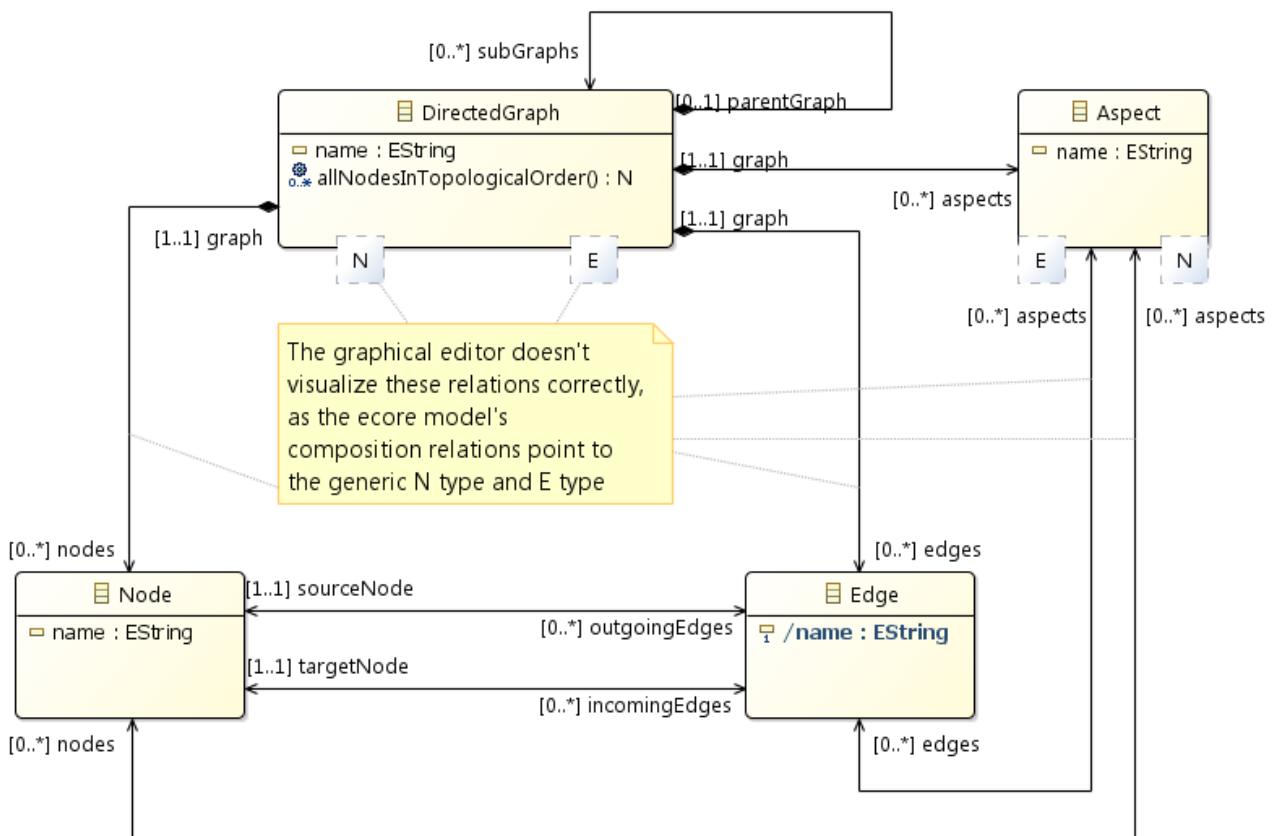

Figure 12. DirectedGraph Metamodel

DirectedGraph is the root of a model. It contains *Node* and *Edge*. *Node* represents nodes in a graph and *Edge* represents edges in a graph. Each node has *outgoingEdges* and *incomingEdges*. Similarly, each edge has one *sourceNode* and *targetNode*.

For stochastic analysis in Eclipse LSAT™, various stochastic annotations have to be assigned to nodes and edges. This is done using *Aspect*. Directed graphs can also contain subgraphs represented by *subGraphs*.

The *DirectedGraph* metamodel contains an operation, as explained in the following.

Name	Class	Description
allNodesInTopologicalOrder():Node	EditableDirectedGraph	Returns all nodes in a directed graph in a topological order.

2.2.2. EditableDirectedGraph Metamodel

Activity flow in activity specifications are represented in a textual representation as follows.

A1 → A2 → A3

where A1, A2 and A3 represent activities and arrows represent the flow between activities. We can also see this example in the form of a directed graph where activities are represented by nodes and arrows between activities represent edges. Thus, we can represent this example using [DirectedGraph Metamodel](#).

However, Xtext is based on LL(k) (see https://en.wikipedia.org/wiki/LL_parser), which does not allow left recursive grammar. Thus, we cannot concatenate edges using [DirectedGraph Metamodel](#). It means that if want to use [DirectedGraph Metamodel](#) to represent the aforementioned activity flow, we have to write two edges, where the first edge is between A1 and A2, and the second edge is between A2 and A3.

To overcome this challenge, we built another metamodel termed as *EditableDirectedGraph* metamodel, where the target of the first edge in the aforementioned example is A2 → A3 instead of A2. Similarly, A3 is the target of the second edge. In this way, we can concatenate different edges.

The structure of these directed graphs is captured by the *EditableDirectedGraph* metamodel. In the following, the *EditableDirectedGraph* metamodel is described.

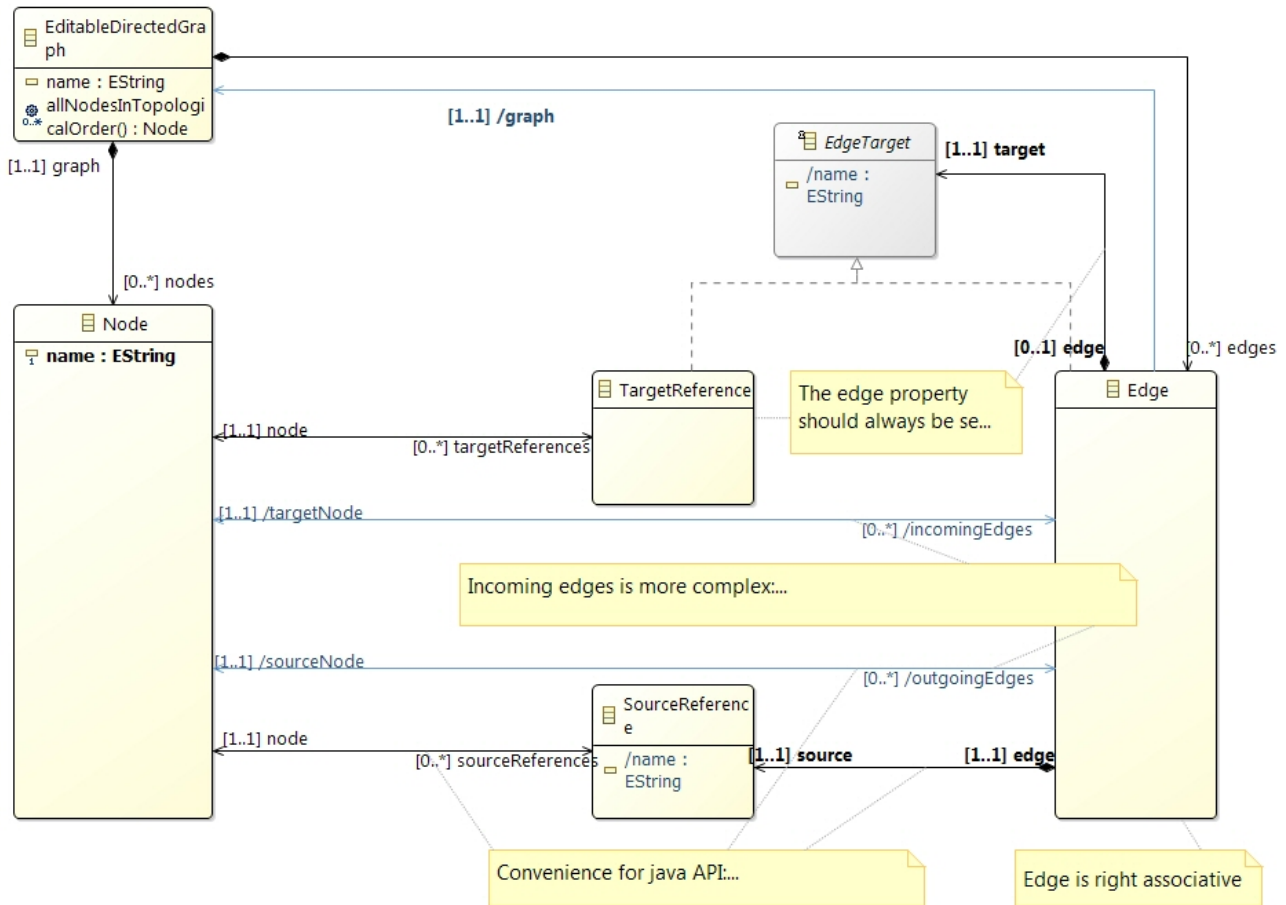

Figure 13. EditableDirectedGraph Metamodel

EditableDirectedGraph is the root of a model. It contains *Node* and *Edge*. To facilitate concatenation of edges in the textual syntax, *Edge* contains a class *EdgeTarget* that has a subtype *TargetReference*. In the textual syntax, target of an edge is represented by *target* which can refer to *edge* or *node*. Thus, target of an edge can be another edge or a node (if it is the last node in the activity flow). For example, in the running example, *target* of the first edge is the next edge $A2 \rightarrow A3$. As $A3$ is the last node in the activity flow, *target* of the second edge is $A3$.

Similarly, *outgoingEdges* of a node are determined by the association *sourceReference*.

2.2.3. Scheduler Metamodel

The scheduler metamodel serves as a basis for the scheduling activities workflow (see [Scheduling activities including Gantt chart visualization](#)). In the following, the Scheduler metamodel is described.

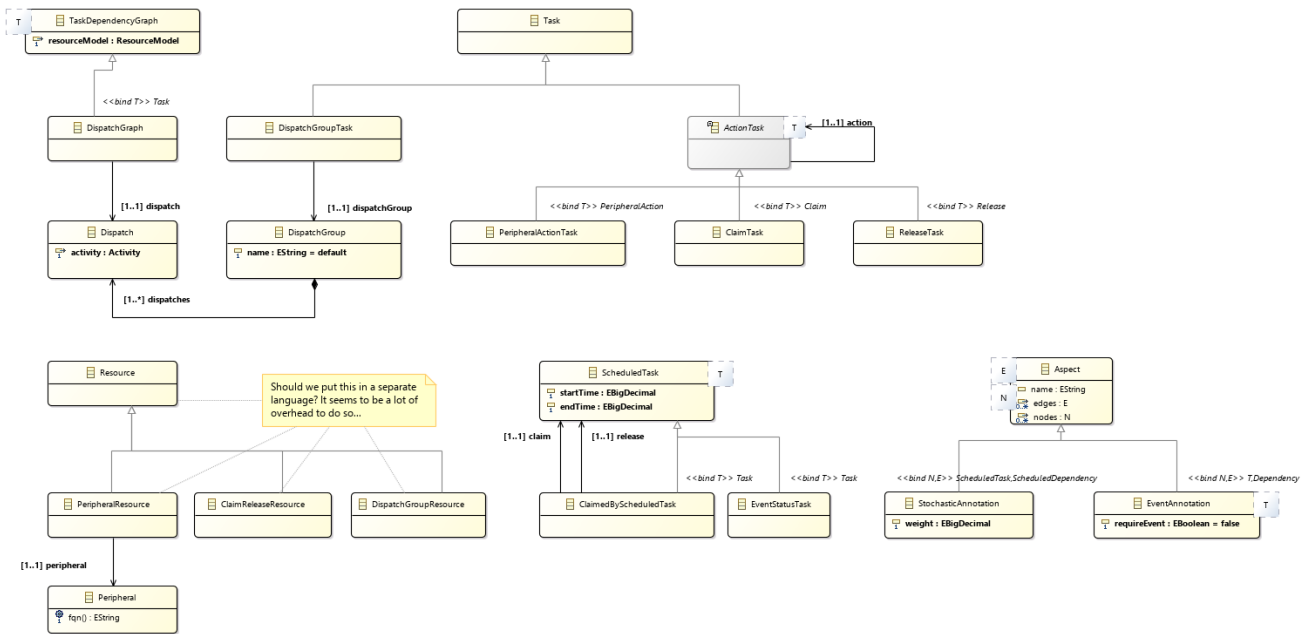

Figure 14. Scheduler Metamodel

It consists of five parts as explained in the following.

Dispatch Graph

Dispatch Graph is used to convert activity dispatching sequence to a directed graph. Therefore, *DispatchGraph* is a type of *TaskDependencyGraph* that refers to [DirectedGraph Metamodel](#). *DispatchGraph* has an association to *Dispatch* that refers to [Logistics Metamodel](#). *Dispatch* contains *DispatchGroup* that also refers to [Logistics Metamodel](#). *DispatchGroup* has an association with *DispatchGroupTask* that is a type of *Task*.

ActionTask

Task has also another subtype *ActionTask* that is used to convert actions in [Activity Metamodel](#) to a graph. *ActionTask* has three subtypes, as explained in the following.

- *ClaimTask* represents the task of claiming a resource.
- *Release* represents the task of releasing a resource.
- *PeripheralAction* represents the actions involving a peripheral.

Resource

In the scheduling activities workflow (see [Scheduling activities including Gantt chart visualization](#)), Gantt charts are generated per resources. Therefore, we need to extract related resources from the activity dispatching sequence. To achieve this objective, we have *Resource* in the scheduler metamodel. *Resource* has three subtypes, as explained in the following.

- *PeripheralResource* represents a Resource whose peripheral has performed an action, e.g., a move or an atomic action.
- *ClaimReleaseResource* represents a Resource that is claimed or released.
- *DispatchGroupResource* represents a Resource involved in an activity sequence.

ScheduledTask

ScheduledTask represents the scheduled task. It has the following attributes.

- *startTime* represents the starting time of a task.
- *endTime* represents the finishing time of a task.
- *sequence* represents the sequence of scheduled activities to which the task belongs.

ScheduledTask has a subtype *ClaimedByScheduledTask* that can *claim* and *release* a scheduled task.

EventStatusTask

EventStatusTask represent the status of an event.

If a particular event is raised but not consumed yet an 'Outstanding' *EventStatusTask* is inserted.

If a particular event is waiting but the event is not raised yet an 'Awaiting' *EventStatusTask* is inserted.

Aspect

As mentioned in [DirectedGraph Metamodel](#), aspects are used to annotate various stochastic features. Therefore, *Aspect* has a subtype *StochasticAnnotation* that has an attribute *weight* representing the timing distribution.

EventAnnotation

A *ScheduledTask* that originated from an *Event* is annotated with an *EventAnnotation*. The annotation contains if the originating event is a *RequireEvent* or a *RaiseEvent*.

2.2.4. PetriNet Metamodel

A Petri net is a directed graph, in which the nodes represent transitions (i.e. events that may occur, represented by bars) and places (i.e. conditions, represented by circles). The directed arcs describe which places are pre- and/or postconditions for which transitions (signified by arrows).

The PetriNet metamodel is shown in the following figure.

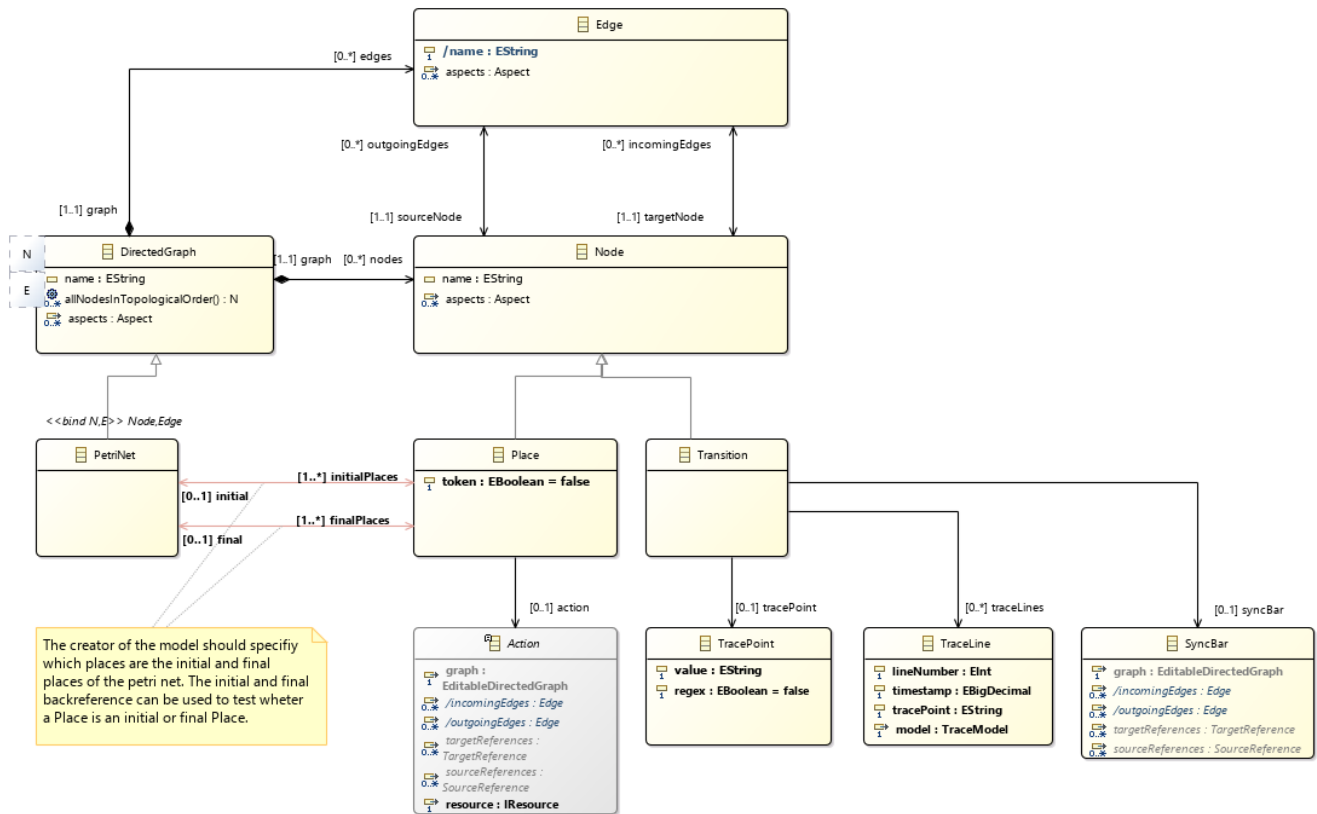

Figure 15. PetriNet Metamodel

As Petri net can be seen as a type of a directed graph, the root of the PetriNet metamodel is *DirectedGraph* with a subtype *PetriNet*. As seen in *DirectedGraph Metamodel*, *DirectedGraph* contains *Edge* and *Node*. Each edge must contain one source and target node.

As nodes in Petri net represent places and transitions, *Edge* has two subtypes, i.e., *Place* and *Transition*. Initial and final places of a Petri net is represented by *initial* and *final* respectively. *Places* has an attribute *token* that represents if a place contains a token or not.

The PetriNet metamodel is used for conformance checking of Eclipse LSAT™ activity dispatching traces containing a recorded list of actions against specification. Thus, *Place* has an association with *Action*.

To relate a trace to a specification in a better way, we add "trace points" to the activity dispatching specification. In other words, activity dispatching sequence is a set of trace points. Trace points are represented as transitions in our Petri net model. Thus, *Transition* has an association with *TracePoint*. Furthermore, sync bars in activity specifications are also represented as transitions in the Petri net model. Therefore, *Transition* has an association with *SyncBar*. Lastly, each transition can contain multiple *traceLines* that provide more information if the conformance checking fails such as line number, time stamp etc. This information is contained as attributes inside *TraceLine*.

2.2.5. MaxPlus Metamodel

The maxplus metamodel is shown in the figure below.

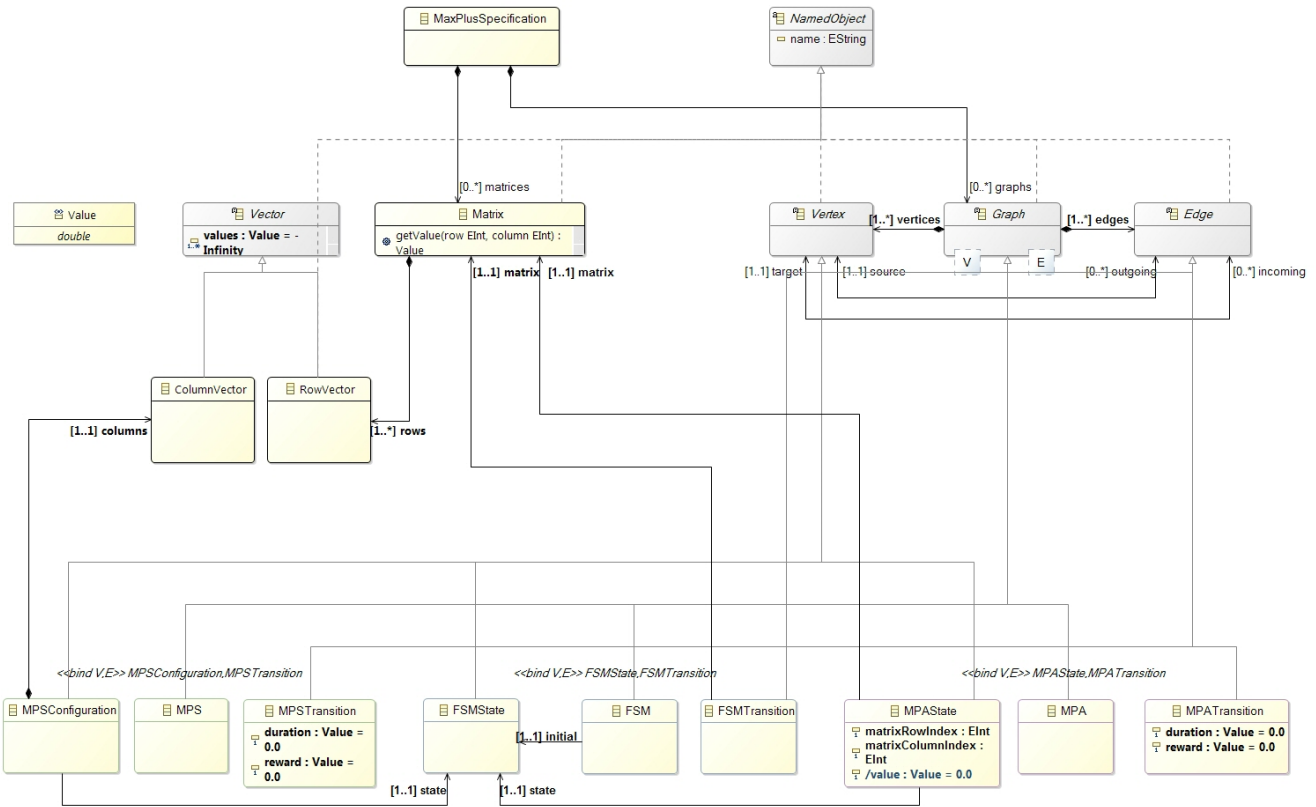

Figure 16. MaxPlus Metamodel

The maxplus metamodel consists of the following major components.

1. *Matrix* representing the max-plus matrices.
2. *Graph* corresponding to the following subtypes.
 1. *FSM* referring to finite state machine used for representing a CIF automata.
 2. *MPS* referring to max-plus state-space.
 3. *MPA* referring to max-plus automaton.

As mentioned earlier, there exists two techniques for analyzing performance using max-plus, i.e., max-plus state-space and max-plus automaton. Thus, *MPS* and *MPA* are utilized for these techniques respectively.

MaxPlusSpecification is the root of a model. It contains *Matrix* and *Graph*. To represents values in matrices conveniently, the maxplus metamodel contains *Value* that is a data type of double. *Matrix* contain row vectors which are a subtype of *Vector* representing that the values contained in the row vectors are of type double. *Vector* has an attribute values of type *Value*. The initial value of values is -Infinity.

Graph contains *Vertex* and *Edge*. Each vertex can have 0 or more outgoing or incoming edges. Each edge has precisely one source and one target. As explained earlier, *Graph* has three subtypes as follows.

- FSM
- MPS
- MPA

Vertex has three subtypes as follows.

- *FSMState* representing a state in *FSM*.
- *MPSConfiguration* representing a configuration state in *MPS*.
 - Each *MPSConfiguration* is associated to exactly one *FSMState*.
- *MPAState* representing a state in *MPA*.
 - Similar to *MPSConfiguration*, each *MPAState* has an exactly one association with *FSMState*.

As *MPS* represents data in the form of columns, each *MPSConfiguration* contains exactly one *ColumnVector*. Furthermore, *MPAState* uses the information in the matrices for performance optimization. For this purpose, *MPAState* has an association with *Matrix*, and has the following attributes.

- *matrixRowIndex* representing the row index of the matrix.
- *matrixColumnIndex* representing the column index of the matrix.

Edge has three subtypes as follows.

- *FSMTransition* representing a transition between states in *FSM*. *FSM* uses the name of the matrices as labels on the transitions. Thus, *FSMTransition* has an association with *Matrix*.
- *MPSTransition* representing a transition between states in *MPS*. *MPSTransition* has an attribute *reward* representing the number of products produced by taking this transition. Moreover, *MPATransition* has another attribute *duration* representing time involved in taking this transition.
- *MPATransition* representing a transition between states in *MPA*. *MPATransition*, similar to *MPSTransition*, has an attribute *reward* representing the number of products produced by taking this transition. Similarly, *MPATransition* has also an attribute *duration* representing time involved in taking this transition.

The maxplus metamodel contains operations, as explained in the following.

Name	Class	Description
getValue(row EInt, column EInt): Value	Matrix	Returns the value at the given row index and column index of a matrix.

Chapter 3. Workflows for aspect models

Now, we have explained all metamodels in Eclipse LSAT™. In this section, we describe different analysis techniques available in Eclipse LSAT™ and related workflows.

3.1. Scheduling activities including Gantt chart visualization

This workflow allows us to visualize an activity dispatch sequence in the form of Gantt charts as shown in the figure below.

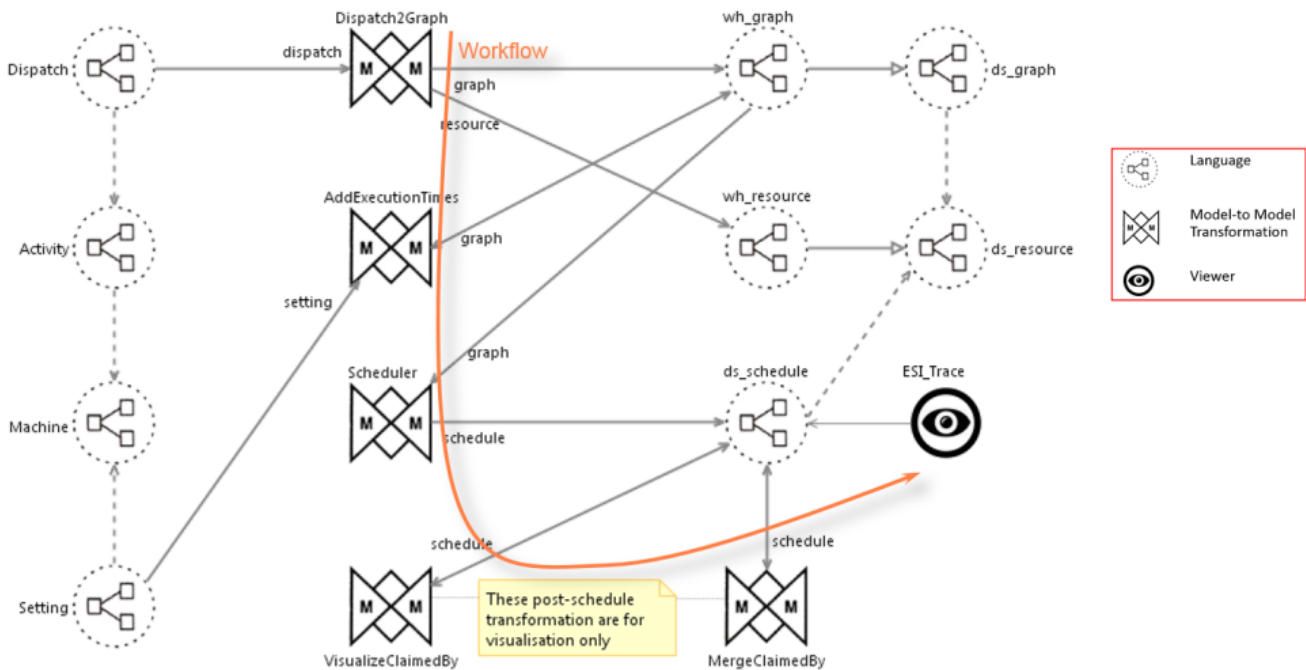

Figure 17. Scheduling activities Workflow

In the following, we explain this workflow.

1. A dispatch model is transformed to a dispatch graph model *lsat_graph* using a model-to-model transformation *Dispatch2Graph* written in QVTo. In the dispatch graph model, a resource might be used by multiple activities in the sequence. However, the *Dispatch2Graph* transformation ensures that only one activity claims a resource at a time. And when the resource is released by the first activity, only then the next active activity can claim that resource. This is done by adding a dependency from the release action of the first activity to the claim action of the second activity. Passive claims (that is claiming a resource to ensure that no actions are performed on the resource) can be done in parallel for multiple activities. (multiple) passive claims are connected to the first preceding *active* Release. If an *active* claim is preceded by *passive* releases than the claim is connected *all* these *passive* releases The Dispatch graphs are explained in detail in [Scheduler Metamodel](#).
2. The action execution times of activities in the dispatch model are calculated and added to *lsat_graph* generated in step 1 using a model-to-model transformation *AddExecutionTimes* written in Xtend.
3. The *lsat_graph* model produced in step 2 is transformed to a *ds_schedule* model using a model-

to-model transformation *Scheduler* written in QVTo. The *Scheduler* transformation projects the graph on a set of resources in such a way that the the execution times of the nodes are respected. For this purpose, the graph is topologically ordered and scheduled onto the available resources in a asap fashion.

4. The *ds_schedule* model generated in step 3 is transformed to *Eclipse TRACE4CPS* using a model-to-text transformation to visualize the *ds_schedule* model in *Eclipse TRACE4CPS*.

3.2. Optimal Makespan/Throughput Scheduling

3.2.1. Introduction

The workflow given in the subsection [Scheduling activities including Gantt chart visualization](#) explains how we can visualize a activity dispatch sequence. However, if a activity dispatch sequence is written by hand, we cannot guarantee optimality. To overcome this challenge, a workflow which can generate an optimal activity dispatch sequence automatically is added to Eclipse LSAT™.

This workflow is summarized in the figure below.

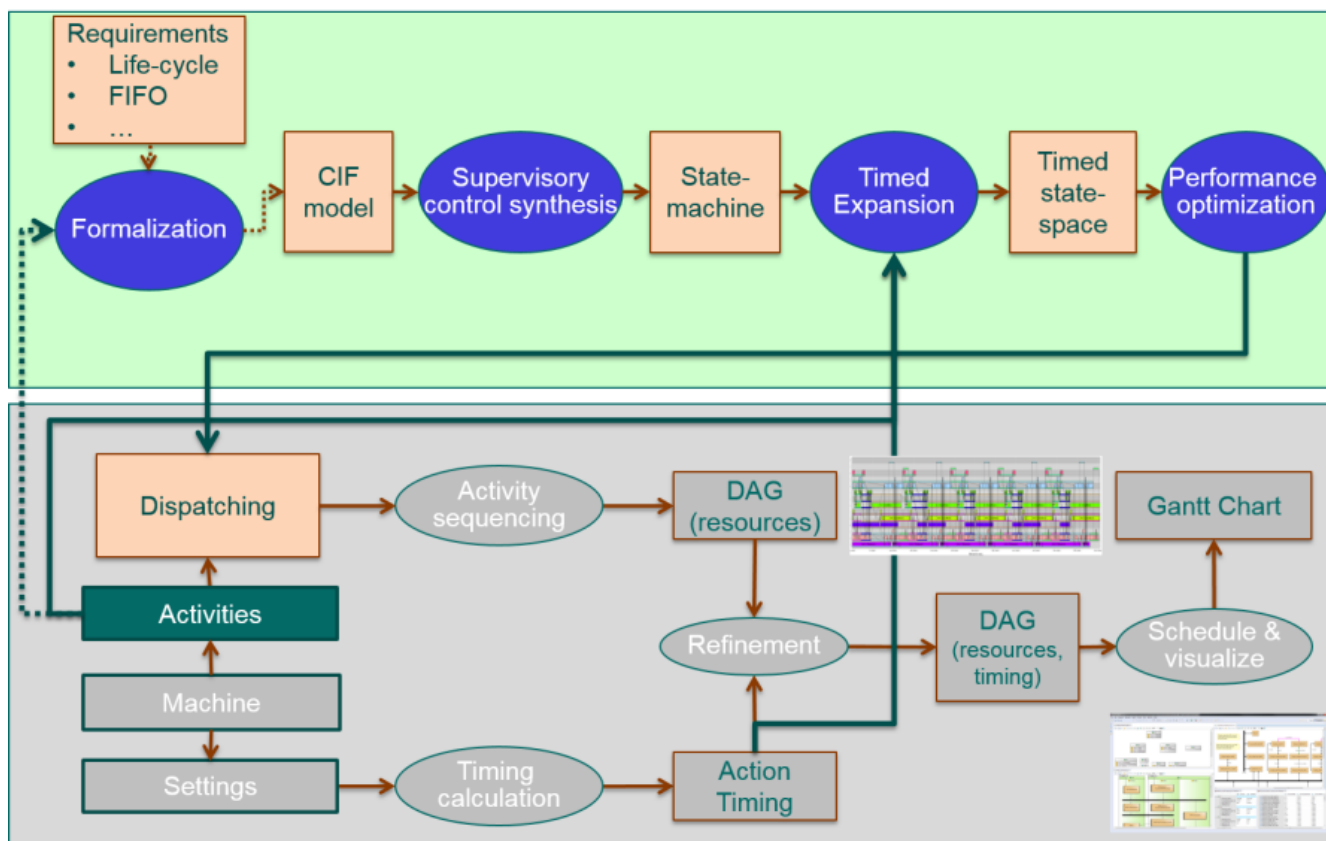

Figure 18. Optimal Makespan/Throughput Scheduling

In this workflow, in addition to Eclipse LSAT™, we also use the following two extra formalisms/tools.

1. Compositional Interchange Format (CIF): CIF is an automata-based modeling language for the specification of discrete event, timed, and hybrid systems. We use CIF to formalize requirements such as life-cycle of products, and synthesize a supervisory controller.

2. Max-Plus Automata: In modeling timed-based systems, quite frequently only the operations max (or min) and + are needed. The max-plus algebra is a mathematical framework that has maximum and addition as the two binary operations. It can be used appropriately to determine marking times within a given Petri net and a vector filled with marking state at the beginning. The MaxPlus metamodel is explained earlier in [MaxPlus Metamodel](#).

3.2.2. Workflow

The figure below shows the workflow used to derive optimal activity dispatching sequence with respect to makespan/throughput.

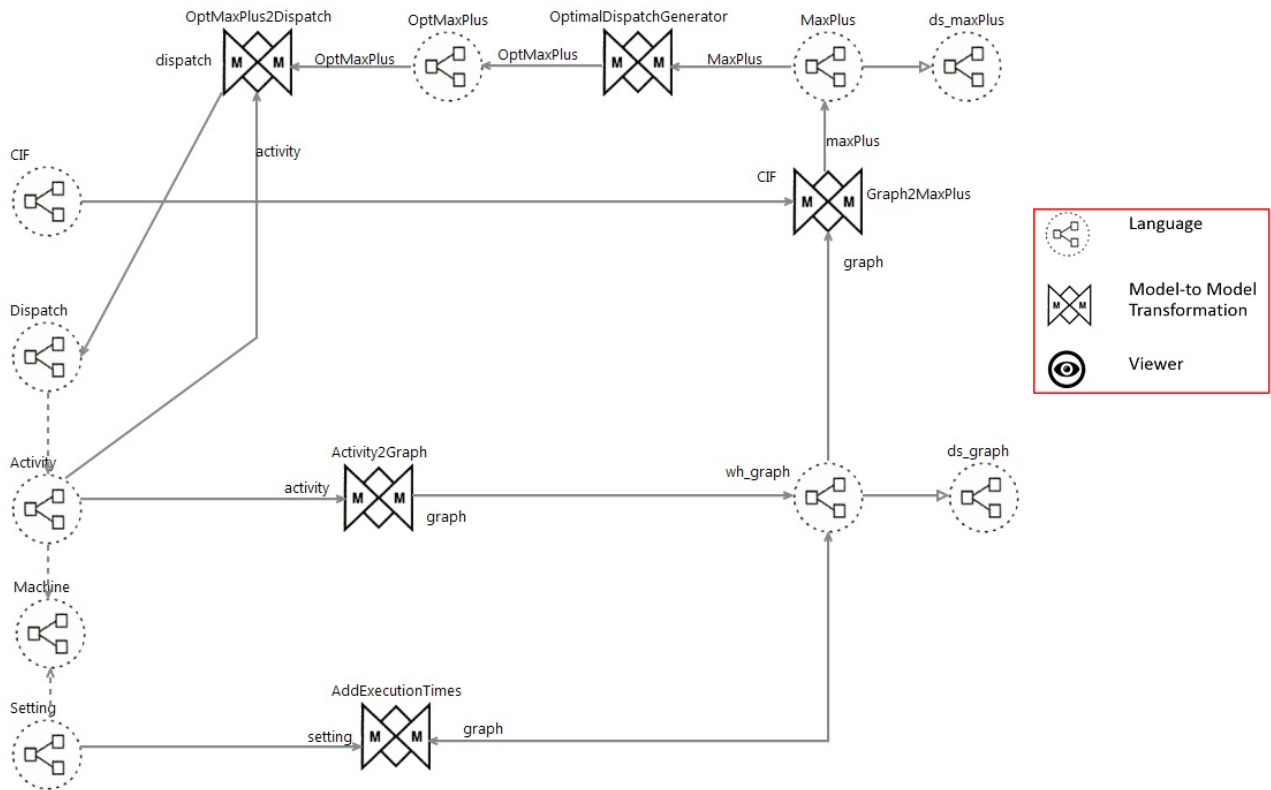

Figure 19. Optimal Makespan/Throughput Scheduling Workflow

1. An activity file is transformed to a editable directed graph model *lsat_graph* using a model-to-model transformation *Activity2Graph* written in QVTo. The EditableDirectedGraph metamodel is explained earlier in [EditableDirectedGraph Metamodel](#).
2. The action execution times of activities in the dispatch model are calculated and added to *lsat_graph* generated in step 1 using a model-to-model transformation *AddExecutionTimes* written in Xtend.
3. The *lsat_graph* model produced in step 2 along with a CIF file is transformed to a *MaxPlus* model using a model-to-model transformation *Graph2MaxPlus* written in QVTo.
4. An algorithm *OptimalDispatchGenerator* takes as input the *MaxPlus* model generated in step 3, performs state-space exploration, and outputs optimal activity dispatch sequence *OptMaxPlus* written in Java.
5. The optimal sequence generated in step 4 *OptMaxPlus* is transformed to a dispatch file using a model-to-model transformation *OptMaxPlus2Dispatch* written in Xtend. The model-to-model transformation *OptMaxPlus2Dispatch* also takes the activity file as an input to determine for

which activity, the activity dispatching sequence is generated.

Activity file preprocessing

Before an activity file is transformed via activity2Graph it is made compatible for MaxPlus processing:

1. Events are transformed to Resources with eventName as name. Each event is replaced by a Claim/Release.
2. For Passive claims an extra Resource is introduced with the following conversion rules for a given resource A:
 - If A contains passive claims in any activity then create resource PA.
 - For an activity *with actions* performed on resource A:
 - claim PA *just before* claim A
 - release PA *just after* release A
 - For an activity that passively claims resource A
 - release A immediately after claiming A
 - for release replace resource A with resource PA
 - claim PA immediately before releasing it

Examples:

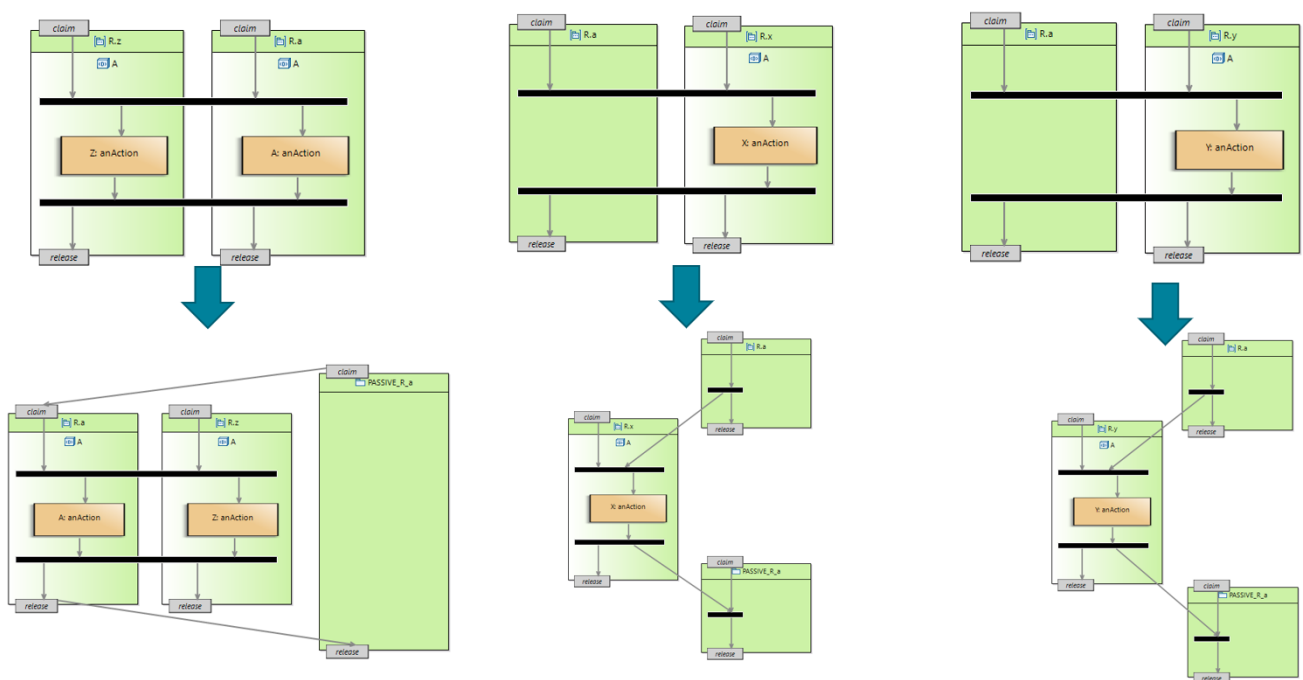

Figure 20. Passive claim transformations

3.3. Conformance Checking

Eclipse LSAT™ also supports conformance checking of activity dispatching sequence. This is done by first recording a list of actions termed as traces. Second, an activity dispatching sequence is transformed to an equivalent Petri net graph. Last, traces and Petri net graph are fed to the

conformance checker, which replays traces on the Petri net to check conformance.

The workflow used to check conformance is shown in the figure below.

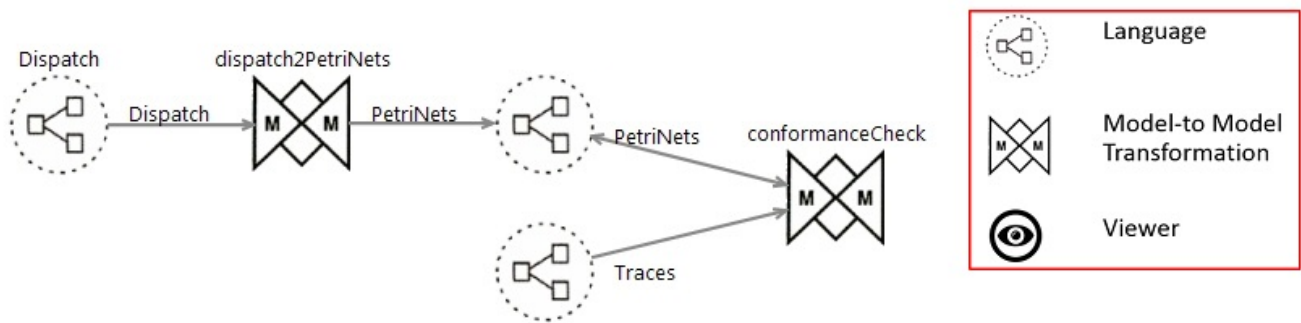

Figure 21. Conformance Checking Workflow

1. A dispatching file is transformed to a *PetriNets* model using a model-to-model transformation *dispatch2PetriNets*. The *PetriNets* metamodel is already explained in [PetriNet Metamodel](#).
2. The *PetriNets* model generated in step 1 is checked for conformance against the *Traces* files using a model-to-model transformation *conformanceCheck* written in QVTo.

Chapter 4. Overview of Plugins

This section presents the overview of plugins in Eclipse LSAT™.

4.1. Machine

Name	Description
org.eclipse.lsat.machine.dsl	Contains the metamodel of machine.
org.eclipse.lsat.machine.dsl.edit	Contains generic reusable classes for building editors for EMF models of machine.
org.eclipse.lsat.machine.teditor	Contains the Xtext grammar definition of machine and all related components such as parser, lexer, linker. validation, etc.
org.eclipse.lsat.machine.teditor.ide	Contains the Xtext language-specific text editor.
org.eclipse.lsat.machine.teditor.ui	Contains advanced functionalities such as content assist, outline tree and quick fix.
org.eclipse.lsat.machine.design	Contains Sirius modeling projects and representations.

4.2. Settings

Name	Description
org.eclipse.lsat.setting.dsl	Contains the metamodel of settings.
org.eclipse.lsat.setting.teditor	Contains the Xtext grammar definition of settings and all related components such as parser, lexer, linker. validation, etc.
org.eclipse.lsat.setting.teditor.ide	Contains the Xtext language-specific text editor.
org.eclipse.lsat.setting.teditor.ui	Contains advanced functionalities such as content assist, outline tree and quick fix.
org.eclipse.lsat.setting.design	Contains Sirius modeling projects and representations.

4.3. Activities

Name	Description
org.eclipse.lsat.activity.dsl	Contains the metamodel of activities.
org.eclipse.lsat.activity.teditor	Contains the Xtext grammar definition of activities and all related components such as parser, lexer, linker. validation, etc.
org.eclipse.lsat.activity.teditor.ide	Contains the Xtext language-specific text editor.

Name	Description
org.eclipse.lsat.activity.teditor.ui	Contains advanced functionalities such as content assist, outline tree and quick fix.
org.eclipse.lsat.activity.diagram.design	Contains Sirius modeling projects and representations.
org.eclipse.lsat.activity.diagram.layout	Contains Eclipse Layout Kernel (ELK) definitions and algorithms.

4.4. Logistics

Name	Description
org.eclipse.lsat.dispatching.dsl	Contains the metamodel of logistics.
org.eclipse.lsat.dispatching.teditor	Contains the Xtext grammar definition of activities and all related components such as parser, lexer, linker. validation, etc.
org.eclipse.lsat.dispatching.teditor.ide	Contains the Xtext language-specific text editor.
org.eclipse.lsat.dispatching.teditor.ui	Contains advanced functionalities such as content assist, outline tree and quick fix.

4.5. Directed Graph

Name	Description
org.eclipse.lsat.common.graph.directed	Contains the metamodel of directed graph.
org.eclipse.lsat.common.graph.directed.editable	Contains the metamodel of editable directed graph.

4.6. MaxPlus

Name	Description
org.eclipse.lsat.common.mpt.dsl	Contains the metamodel of maxplus.
org.eclipse.lsat.common.mpt.dsl.edit	Contains generic reusable classes for building editors for EMF models of maxplus.
org.eclipse.lsat.common.mpt.dsl.editor	Contains a maxplus editor.
org.eclipse.lsat.mpt.api	Contains algorithms for computing optimal makespan/throughput.
org.eclipse.lsat.mpt.feature	
org.eclipse.lsat.mpt.ui	Contains ui features for computing optimal makespan/throughput.

Name	Description
org.eclipse.lsat.mpt.transformation	Contains transformations for computing optimal makespan/throughput explained in Section Optimal Makespan/Throughput Scheduling .

4.7. Scheduling Activities including Gantt Chart Visualization

Name	Description
org.eclipse.lsat.scheduler.graph.dsl	Contains the metamodel of scheduler graph.
org.eclipse.lsat.scheduler.ui	Contains ui features for scheduling.
org.eclipse.lsat.scheduler	Contains transformations for scheduling explained in Section Scheduling activities including Gantt chart visualization .
org.eclipse.lsat.scheduler.etf	Contains transformations from a schedule to Eclipse TRACE4CPS.
org.eclipse.lsat.motioncalculator.api	Contains the API for computing timings for different motion types, e.g., point-to-point and distance moves, and motion profiles settings.
org.eclipse.lsat.motioncalculator.json(.native)	Contains support classes to easily implement a native motion calculator.
org.eclipse.lsat.timing	Contains algorithms for computing timings for different motion types, e.g., point-to-point and distance moves, and motion profiles settings, e.g., normal distribution, triangular distribution, and Pert distribution.
org.eclipse.lsat.timinganalysis.ui	Contains ui features for computing timings e.g., playing and exporting animations.

4.8. Conformance Checking

Name	Description
org.eclipse.lsat.petri_net.dsl	Contains the metamodel of Petri Net.
org.eclipse.lsat.petri_net.design	Contains Sirius modeling projects and representations.
org.eclipse.lsat.conformance	Contains transformations for conformance checking of traces explained in Section Conformance Checking .
org.eclipse.lsat.conformance.ui	Contains ui functions for conformance checking of traces.

4.9. Throughput per Resource

Name	Description
org.eclipse.lsat.resource_throughput.ui	Returns ui functions and algorithms for calculating throughput per resource.

4.10. Documentation

Name	Description
org.eclipse.lsat.documentation	Contains AsciiDoc files of the Eclipse LSAT™ user guide.
org.eclipse.lsat.design	Contains AsciiDoc files of this Eclipse LSAT™ design documentation.
org.eclipse.lsat.intro	Contains help files of Eclipse LSAT™.

Chapter 5. Developing

5.1. Development environment setup

Follow these instructions to set up an Eclipse LSAT™ development environment.

To create a development environment (first time only):

- Get the Eclipse Installer:
 - Go to <https://www.eclipse.org/> in a browser.
 - Click on the big [**Download**] button at the top right.
 - Download Eclipse Installer, 64 bit edition, using the [**Download x86_64**] button.
- Start the Eclipse Installer that you downloaded.
- Use the hamburger menu at the top right to switch to advanced mode.
- For Windows:
 - When asked to keep the installer in a permanent location, choose to do so. Select a directory of your choosing.
 - The Eclipse installer will start automatically in advanced mode, from the new permanent location.
- For Linux:
 - The Eclipse installer will restart in advanced mode.
- Continue with non-first time instructions for setting up a development environment.

To create a development environment:

- Ensure you are using the latest version of the Eclipse Installer:
 - One option is to download it again, as per the 'first time' instructions above.
 - Another option is to update your existing Eclipse Installer. In the Eclipse Installer, when in advanced mode, click the 'Install available updates' button. This button with the two-arrows icon is located at the bottom-left part of the window, next to the version number. Wait for the update to complete and the Eclipse Installer to restart. If the button is disabled (grey), you are already using the latest version.
- In the first wizard window:
 - Select *Eclipse IDE for Eclipse Comitters* from the big list at the top.
 - Select *2020-06* for *Product Version*.
 - For *Java 1.8+ VM* select a JRE 1.8 that is installed on your local machine. Use the button to the right of the dropdown to manage the installed virtual machines on your system. The JDK can be downloaded from e.g. [Oracle](#) or [Adoptium](#).
 - Choose whether you want a P2 bundle pool (recommended).

- Click [**Next**].
- In the second wizard window:
 - Use the green '+' icon at the top right to add the Oomph setup.
 - For *Catalog*, choose *Eclipse Projects*.
 - For *Resource URIs*, enter <https://gitlab.eclipse.org/eclipse/lsat/lsat/-/raw/develop/lsat.setup> and make sure there are no spaces before or after the URL.
 - Click [**OK**].
 - Check the checkbox for *Eclipse LSAT™*, from the big list. It is under *Eclipse Projects / <User>*.
 - At the bottom right, select the *develop* stream.
 - Click [**Next**].
- In the third wizard window:
 - Enable the *Show all variables* option to show all options.
 - Choose a *Root install folder* and *Installation folder name*. The new development environment will be put at `<root_installation_folder>/<installation_folder_name>`.
 - Fill in the *Eclipse LSAT™ Git clone URL*:
 - Committers with write access to the Eclipse LSAT™ official GitLab repository can use the default URL <https://gitlab.eclipse.org/eclipse/lsat/lsat.git>.
 - Contributors can use the same URL, but as they don't have write access, they will not be able to push to the remote repository. They can instead make a fork of the official Git repository. Then they can fill in the URL of their clone instead, i.e. https://gitlab.eclipse.org/<username>/<cloned_repo_name>.git, with `<username>` replaced by their Eclipse Foundation account username, and `<cloned_repo_name>` replaced by the name of the cloned repository, which defaults to `lsat`.
 - For *Eclipse Foundation account full name* fill in your full name (first and last name) matching the full name in your Eclipse Foundation account. This will be used as name for Git commits.
 - For *Eclipse Foundation account email address* fill in the email address associated with your Eclipse Foundation account. This will be used as email for Git commits.
 - Click [**Next**].
- In the fourth wizard window:
 - Select [**Finish**].
- Wait for the setup to complete and the development environment to be launched.
 - If asked, accept any licenses and certificates.
- Press [**Finish**] in the Eclipse Installer to close the Eclipse Installer.
- In the new development environment, observe Oomph executing the startup tasks (such as Git clone, importing projects, etc). If this is not automatically shown, click the rotating arrows icon in the status bar (bottom right) of the new development environment.
- Wait for the startup tasks to finish successfully.



If you don't open the Oomph dialog, the status bar icon may disappear when the tasks are successfully completed.





If you have any issues during setting up the development environment, consider the following:

- You can set the following environment variables to force the use of IPv4, in case of any issues accessing/downloading remote files:

```
_JAVA_OPTIONS=-Djava.net.preferIPv4Stack=true
_JPI_VM_OPTIONS=-Djava.net.preferIPv4Stack=true
```

After setting them, make sure to fully close the Eclipse Installer and then start it again, for the changes to be picked up.

In your new development environment, consider changing the following settings:

- For the *Package Explorer* view:
 - Enable the *Link with Editor* setting, using the  icon.
 - Enable showing resources (files/folders) with names starting with a period. Open the *View Menu* ( (). Uncheck the *. * resources* option and click [**OK**].
 - Group projects into working sets.
 - Open the *View Menu* ().
 - Open the *View Menu* (). Use [**Select All**] to select all working sets and click [**OK**].

5.2. Building with Maven



Eclipse LSAT™ should be built using a *Java 1.8 VM*. The JDK can be downloaded from e.g. [Oracle](#) or [Adoptium](#).

To test which Java version is used by Maven, type `mvn -version` in a command shell.

To build Eclipse LSAT™ with Maven execute the following command in the root:

Linux

```
./build.sh
```

Windows

```
.\build.cmd
```

Other

```
mvn
-Dtycho.pomless.aggregator.names=documentation,features,maxplustool,plugins,common,releng,sc
heduler,product,tests
```



In the remainder of this document this command will be referred to as `build.sh`

5.3. License header

The [Maven build](#) uses [license-maven-plugin](#) to determine if the [correct license headers](#) are used for source files. If the header is incorrect the build fails.

Handy commands:

- To only run the check execute: `./build.sh license:check`.
- To automatically add/update execute: `./build.sh license:format`.

5.4. Third party notice

Whenever dependencies change, [NOTICE.asciidoc](#) has to be updated.

Appendix A: How to implement your own custom motion profile



Before you start, a fully setup LSAT development environment in Eclipse is required.

Create a new motion calculator



In order to benefit fully from this explanation, you must be at least familiar with Eclipse Plugin Development. If this is not the case, please have a look [Eclipse Plugin Development tutorial](#) and [Eclipse Extension Points and Extensions - Tutorial](#)

1. Create a new Eclipse plugin project. This project will implement your custom motion profile. Make sure the box for making changes to the UI is not checked.

New Plug-in Project

Content
Enter the data required to generate the plug-in.

Properties

ID:

Version:

Name:

Vendor:

Execution Environment:

Options

Generate an activator, a Java class that controls the plug-in's life cycle
Activator:

This plug-in will make contributions to the UI

Enable API analysis

Rich Client Application

Would you like to create a rich client application? Yes No

2. Add an extension point of type **org.eclipse.lsat.timing.calculator** in the **plugin.xml** file. This extension point is needed to define the capabilities of your new motion calculator. When asked if you want to add the project as a dependency, select yes.

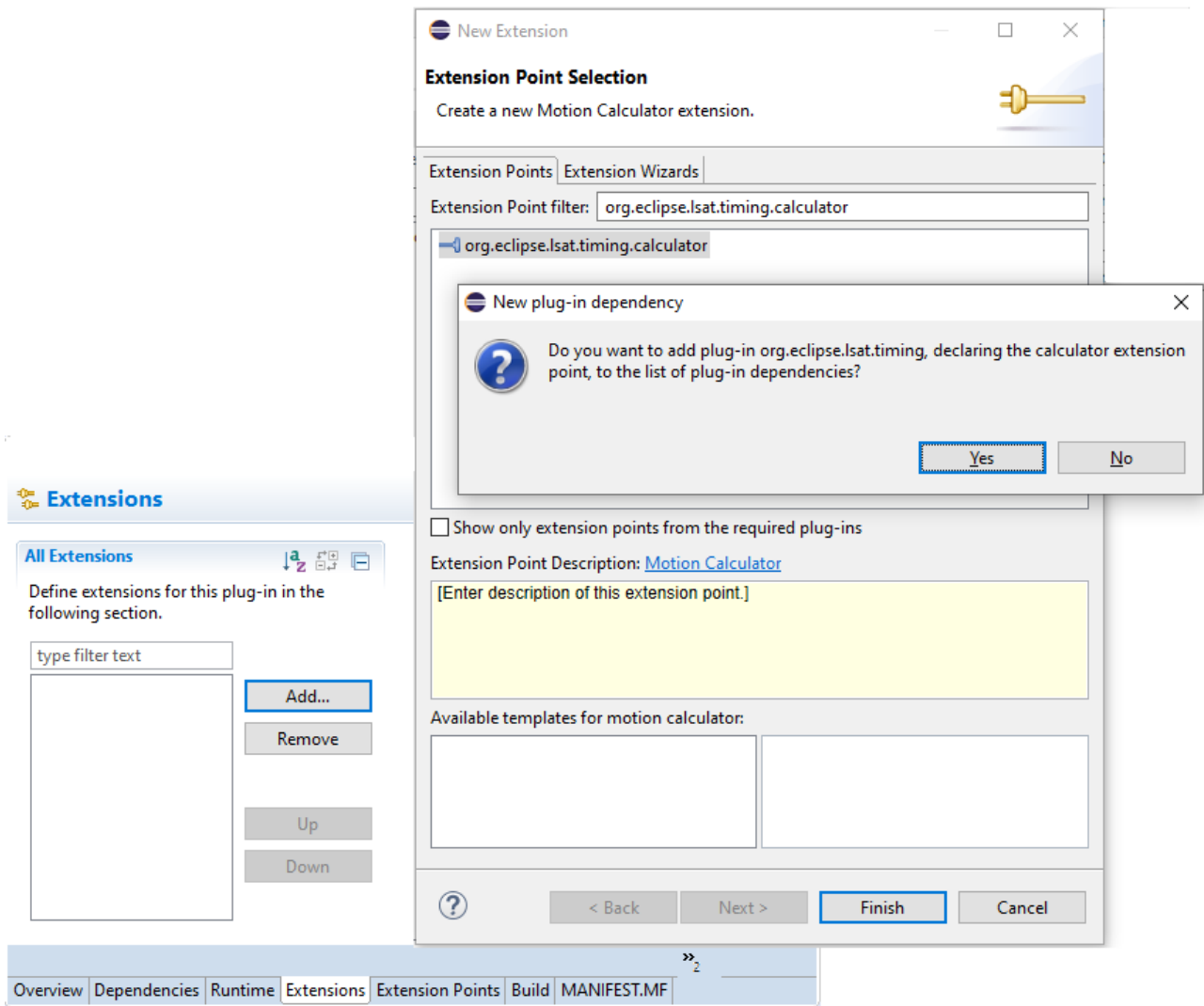

3. Add a **MotionProfile** for each supported motion profile in the **Extensions** tab. Fill in the **name** of the new profile and the required **key** that will be used in the specification. For each motion profile, declare their motion **Parameters**. A graphical and textual example of the **plugin.xml** are shown below.



Our custom motion calculator also supports the default *third order point-to-point* motion profile.

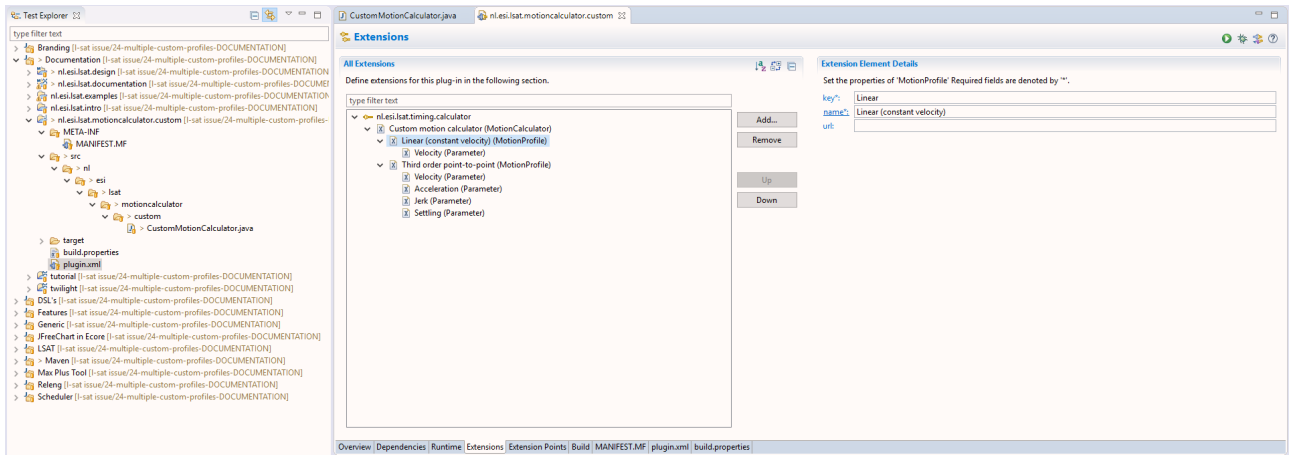

Figure 22. Example with a custom (Linear) motion profile and the default (Third order point-to-point) motion profile.



You can also modify the [plugin.xml](#) file of your motion calculator plugin to define motion profiles and parameters.

Listing 1. `plugin.xml` showing the motion profile and parameter specifications

```
<MotionProfile
  key="Linear"
  name="Linear (constant velocity)">
  <Parameter
    key="V"
    name="Velocity"
    required="true">
  </Parameter>
</MotionProfile>
<MotionProfile
  key="ThirdOrderP2P"
  defaultProfile="true"
  name="Third order point-to-point">
  <Parameter
    key="V"
    name="Velocity"
    required="true">
  </Parameter>
  <Parameter
    key="A"
    name="Acceleration"
    required="true">
  </Parameter>
  <Parameter
    key="J"
    name="Jerk"
    required="true">
  </Parameter>
  <Parameter
    key="S"
    name="Settling"
    required="false"> ①
  </Parameter>
</MotionProfile>
```

① Parameters can be specified to be optional, but default values cannot be specified for these parameters. The defaults must be part of the implementation

4. Select the extension point and create a motion calculator **class** by clicking the **class:*** hyperlink. Below you can see an example of our [CustomMotionCalculator](#) class.



Do not name your class `MotionCalculator` as it can lead to name clashes. Use a name like e.g **CustomMotionCalculator**.



Make sure to implement the `org.eclipse.lsat.timing.calculator.MotionCalculator` interface and optionally extend the `org.eclipse.lsat.timing.calculator.PointToPointMotionCalculator` if you want your motion calculator to support the default *third order point-to-point* motion profile, like our `CustomMotionCalculator`.

Listing 2. `CustomMotionCalculator.java` as an example of the motion calculator implementations.

```
public class CustomMotionCalculator extends PointToPointMotionCalculator implements
MotionCalculator { ①
    protected static final String LINEAR_MOTION_PROFILE_KEY = "Linear";

    @Override
    public void validate(List<MotionSegment> segments) throws
MotionValidationException { ②
        if (MotionSegmentUtilities.isMotionProfile(segments,
THIRD_ORDER_POINT_TO_POINT_MOTION_PROFILE_KEY)) {
            super.validate(segments); ③
        } else if (MotionSegmentUtilities.isMotionProfile(segments,
LINEAR_MOTION_PROFILE_KEY)) {
            // Add your custom motion validations here
            if (segments.size() > 1) {
                throw new MotionValidationException(
                    "Event-on-the-fly (move passing) is not supported by
CustomMotionCalculator", segments);
            }
            if (MotionSegmentUtilities.getSettledSetPointIds(segments).size() > 0)
{
                throw new MotionValidationException("Settling is not supported by
CustomMotionCalculator", segments);
            }
        } else {
            throw new MotionValidationException(
                "Mixing motion profiles in one move is not supported by
CustomMotionCalculator", segments);
        }
    }

    @Override
    public List<Double> calculateTimes(List<MotionSegment> segments) throws
MotionException { ④
        if (MotionSegmentUtilities.isMotionProfile(segments,
THIRD_ORDER_POINT_TO_POINT_MOTION_PROFILE_KEY)) {
            return super.calculateTimes(segments);
        }

        // Validate method already validated that motion profile equals
        LINEAR_MOTION_PROFILE_KEY in this case
        // Validate method already validated that the segments array contains
        exactly 1 element
    }
}
```

```

        return Arrays.asList(calculateLinearTime(segments.iterator().next())
            .doubleValue());
    }

    @Override
    public Collection<PositionInfo> getPositionInfo(List<MotionSegment> segments)
        throws MotionException { ⑤
        if (MotionSegmentUtilities.isMotionProfile(segments,
            THIRD_ORDER_POINT_TO_POINT_MOTION_PROFILE_KEY)) {
            return super.getPositionInfo(segments);
        }

        // Validate method already validated that motion profile equals
        LINEAR_MOTION_PROFILE_KEY in this case
        // Validate method already validated that the segments array contains
        exactly 1 element
        MotionSegment segment = segments.iterator().next();

        BigDecimal segmentTime = calculateLinearTime(segment);
        List<PositionInfo> result = new ArrayList<>();
        BigDecimal position = BigDecimal.valueOf(0);
        for (MotionSetPoint motionSetPoint: segment.getMotionSetpoints()) {
            BigDecimal setPointTime = calculateLinearTime(motionSetPoint);

            PositionInfo positionInfo = new PositionInfo(motionSetPoint.getId());
            position = MotionSetPointUtilities.getFrom(motionSetPoint, position);
            positionInfo.addTimePosition(0d, position.doubleValue());
            position = MotionSetPointUtilities.getFrom(motionSetPoint, position.
                add(motionSetPoint.getDistance()));
            positionInfo.addTimePosition(setPointTime.doubleValue(), position
                .doubleValue());
            // If setPoint arrives early at To, add a third sample
            if (setPointTime.compareTo(segmentTime) < 0) {
                positionInfo.addTimePosition(segmentTime.doubleValue(), position
                    .doubleValue());
            }
            result.add(positionInfo);
        }
        return Collections.unmodifiableCollection(result);
    }

    private BigDecimal calculateLinearTime(MotionSegment segment) {
        BigDecimal maxTime = BigDecimal.ZERO;
        for (MotionSetPoint motionSetPoint: segment.getMotionSetpoints()) {
            maxTime = maxTime.max(calculateLinearTime(motionSetPoint));
        }
        return maxTime;
    }

    private BigDecimal calculateLinearTime(MotionSetPoint motionSetPoint) {
        if (!motionSetPoint.doesMove()) {

```

```

        return BigDecimal.ZERO;
    }
    BigDecimal velocity = motionSetPoint.getMotionProfileArgument
(VELOCITY_PARAMETER_KEY);
    return motionSetPoint.getDistance().abs().divide(velocity, 6, RoundingMode
.HALF_UP);
    }
}

```

- ① To reuse the built in default motion calculator of Eclipse LSAT™ extend your newly created class with **PointToPointMotionCalculator**.
- ② Start with the implementation of the **validate** method. The constraints can be on an individual level or combined.
- ③ If you are reusing the **PointToPointMotionCalculator**, you can reuse the validate from the super class.
- ④ Continue with the implementation of **calculateTimes**. This method is called after validation. It is mandatory and its purpose is to determine the duration of the move.
- ⑤ Finally implement the **getPositionInfo**. This method is called after validation when a motion plot is created and calculates for each setpoint its position over time. For incremental development this function could first be left empty, till the calculator works. Additionally, **getPositionInfo** is used to visualizes the profile. For more info, check out **Plotting a move** in Chapter 3 from the user guide.

Implementor notes

- The motion calculator always calculates a move for a single peripheral from standstill to standstill.
- A move consists of one or more (in case of a passing move) **MotionSegments**.
- The default PointToPointMotionCalculator only supports a passing move, when for all **MotionSegments** the motion profile is the same and its parameter values are the same.
- Each **MotionSegment** contains a **MotionSetPoint** for every setpoint of the peripheral.
- A **MotionSetPoint** indicates where the movement comes from and where it needs to go.

Test your new motion calculator

1. Start the Eclipse LSAT™ runtime environment from within the development environment by means of the predefined Eclipse LSAT™ launch target.
2. Select your custom motion calculator via the **Window › Preferences › Logistics › Motion Calculator** menu.

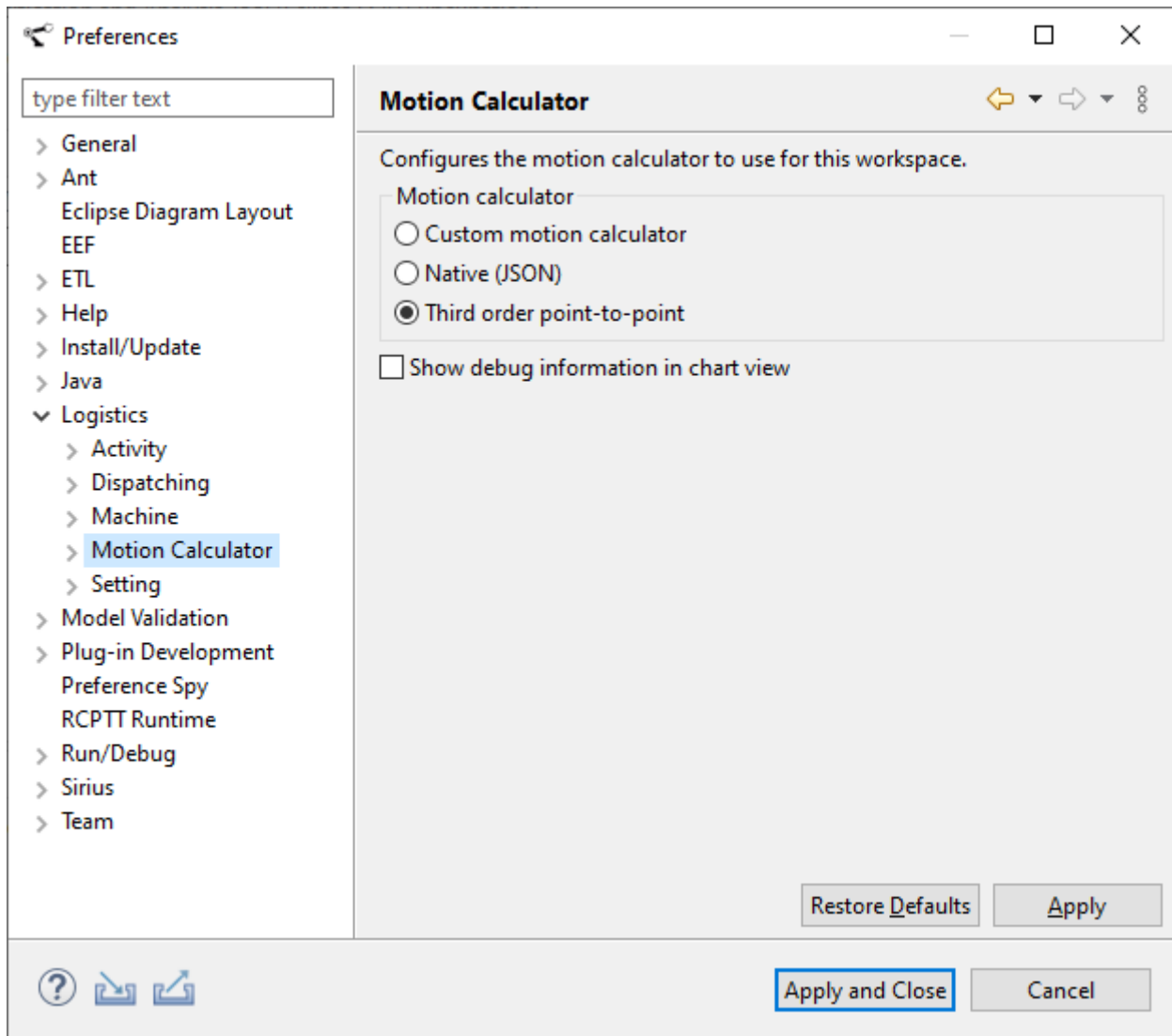

3. Open the .settings file of an Eclipse LSAT™ specification.
 - a. Go to the Axis and then Profiles section.
 - b. Put your mouse cursor the existing profile e.g normal.
 - c. Press Ctrl + Space. Select the previously defined motion profile, **Linear** in our code example.

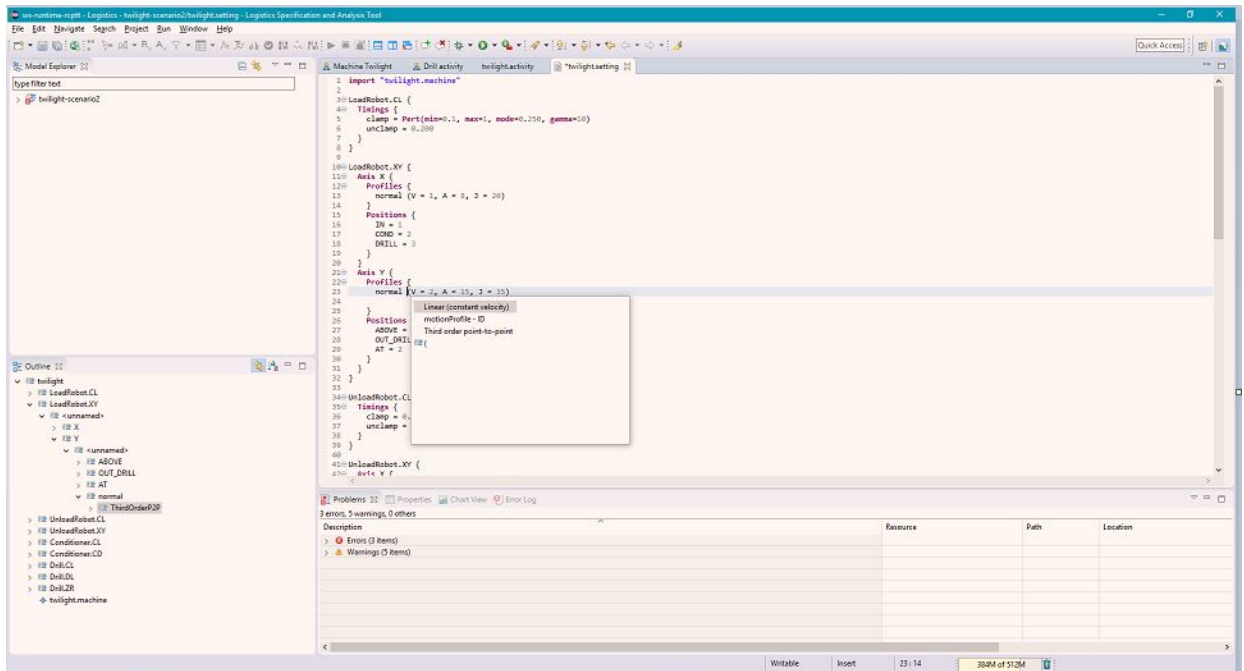

d. Finish by defining the values for the parameters that the custom motion profile requires.

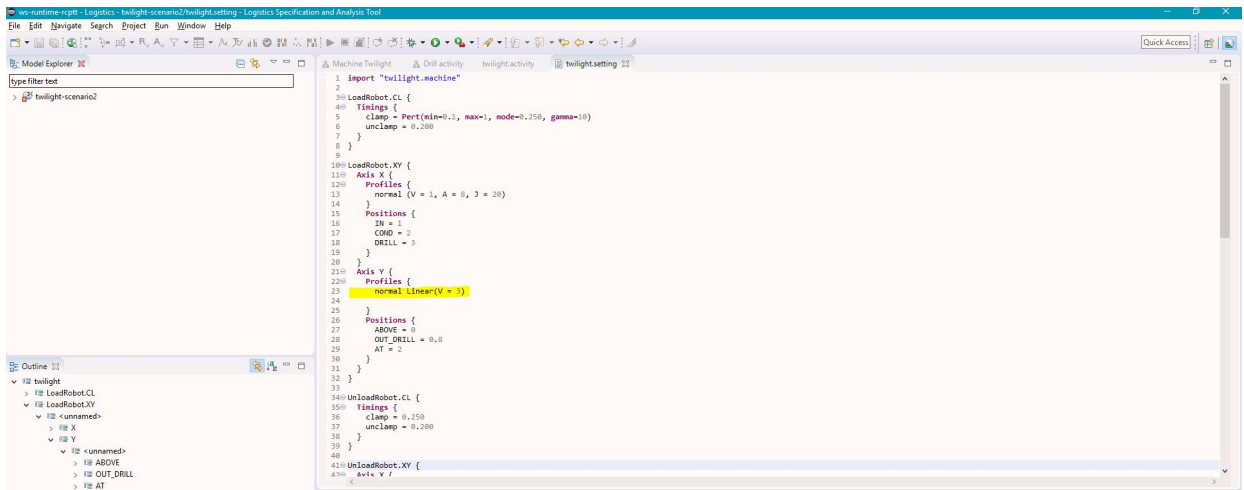

Appendix B: How to implement a custom motion calculator with Json

Eclipse LSAT™ provides a customisable API to translate specified motion profiles into duration times or time/position info.

The API is used to analyse throughput in timing analysis and to plot moves in an activity diagram.

Third parties have the possibility to implement their own Motion Calculator in their own programming language of choice using Json. This appendix describes what needs to be done for that.

Terminology

Term	Description	Remark
Motion profile	A set of parameters for a motion calculator implementation to calculate times or position info.	A motion profile can be supplied by third parties. For example a Third order profile with parameters Velocity, Acceleration, Jerk If more than one profile is supplied then exactly one profile must have <code>defaultProfile</code> set to true.
Motion Segment	Specifies a move from position A to B along one or more specified axes. Each axis movement is specified in a Motion Set Point.	
Motion Segment Array	A concatenated set of moves from position to position where in between segments specify passing positions while moving. The first segment starts with velocity 0 and the last segment ends with velocity 0. This is typically called a point-to-point move.	
Motion Set Point	A movement along one axis containing the from, to position or distance and the profile parameter values.	A setpoint has an id which typically represents an axis If a motion segment contains more than one setpoint they are all moving at the same moment in time.

Term	Description	Remark
Supported Profiles	The list of one or more profiles supported by a Motion Calculator.	
Validate	Validates if the given data can be handled without errors by a Motion Calculator.	
Calculate Times	Calculate duration of a set of (concatenated) moves. An array with times in seconds for each motion segment is returned. The value is the delta time against beginning of the move.	
Get Position Info	Get the position info per of a set of (concatenated) moves. An array containing (absolute) times (duration since start in seconds) and (absolute) position (in meter) per set point id is returned	

Json Interface

Json data is transported using a synchronous shared library function call.

Third parties should implement this function and offer it in a shared library.

Listing 3. Json server.

```
#ifndef JSON_SERVER_H
#define JSON_SERVER_H

/*
  Interface call to a Motion Calculator Json server.
  See the LSAT design documentation for the json data to be exchanged.

  request contains the UTF-8 encoded Json request data
  response is a buffer of size response_size that can be used to write
  the json response to. response must be UTF-8 encoded.

  the function should return 0 except when the response does not fit
  into the response buffer then it should return a non 0 value.

  error messages not related to `buffer overflows` should be return into
  the json response.
*/
extern "C" int request(char* response, const char* request, size_t response_size);

#endif // JSON_SERVER_H
```

Configuring the shared library

The shared library can be configured in Eclipse LSAT™ preferences. Make sure the library is visible in the execution path of Eclipse LSAT™

Preferences

type filter text

- > General
- > Ant
- Eclipse Diagram Layout
- EEF
- > ETL
- > Help
- > Install/Update
- > Java
- ▼ Logistics
 - > Activity
 - > Dispatching
 - > Machine
 - ▼ Motion Calculator
 - Native (JSON)**
 - > Setting
- > Model Validation
- > Plug-in Development
- Preference Spy
- RCPTT Runtime
- > Run/Debug
- > Sirius
- > Team

Native (JSON)

Configures the name of the third party shared library.

Library name (without extension) :

Write Messages to console :

Restore Defaults Apply

? Apply and Close Cancel

Json Schema for request and response

The schema can be used to validate Json and/or to bind to a specific language like c, cpp, c#, ada, etc.

Listing 4. Request schema.

```
{
  "$schema": "http://json-schema.org/draft-04/schema#",
  "type": "object",
  "properties": {
    "requestType": {
      "type": "string",
      "enum": ["Validate", "CalculateTimes", "PositionInfo", "SupportedProfiles"]
    },
    "segments": {
      "type": "array",
      "items": [
        {
          "type": "object",
          "properties": {
            "setPoints": {
              "type": "array",
              "items": [
                {
                  "type": "object",
                  "properties": {
                    "id": {
                      "type": "string"
                    },
                    "from": {
                      "type": "number"
                    },
                    "to": {
                      "type": "number"
                    },
                    "distance": {
                      "type": "number"
                    },
                    "settling": {
                      "type": "boolean"
                    },
                    "motionProfileId": {
                      "type": "string"
                    },
                    "arguments": {}
                  }
                }
              ]
            },
            "required": [
              "id",
              "distance",
              "motionProfile"
            ]
          }
        }
      ]
    }
  }
}
```

```

        }
      ]
    },
    "id": {
      "type": "string"
    }
  },
  "required": [
    "setPoints",
    "id"
  ]
}
]
}
},
"required": [
  "requestType"
]
}

```

Listing 5. Response schema.

```

{
  "$schema": "http://json-schema.org/draft-04/schema#",
  "type": "object",
  "properties": {
    "requestType": {
      "type": "string",
      "enum": ["Validate", "CalculateTimes", "PositionInfo", "SupportedProfiles"]
    },
    "times": {
      "type": "array",
      "items": [
        {
          "type": "number"
        }
      ]
    },
    "positionInfo": {
      "type": "array",
      "items": [
        {
          "type": "object",
          "properties": {
            "setPointId": {
              "type": "string"
            },
            "timePositions": {
              "type": "array",
              "items": [
                {

```

```

        "type": "array",
        "items": [
            {
                "type": "number"
            },
            {
                "type": "number"
            }
        ]
    },
    {
        "type": "array",
        "items": [
            {
                "type": "number"
            },
            {
                "type": "number"
            }
        ]
    }
]
},
"required": [
    "id",
    "positions"
]
}
]
}
},
"motionProfiles": {
    "type": "array",
    "items": [
        {
            "type": "object",
            "properties": {
                "key": {
                    "type": "string"
                },
                "name": {
                    "type": "string"
                },
                "defaultProfile": {
                    "type": "boolean"
                },
                "url": {
                    "type": "string"
                },
                "parameters": {

```

```

    "type": "array",
    "items": [
      {
        "type": "object",
        "properties": {
          "key": {
            "type": "string"
          },
          "name": {
            "type": "string"
          },
          "required": {
            "type": "boolean"
          }
        },
        "required": [
          "key",
          "name",
          "required"
        ]
      }
    ],
    "required": [
      "key",
      "name",
      "parameters"
    ]
  },
  "required": [
    "requestType"
  ]
}

```

Examples of Json messages

Supported Profiles

```
{  
  "requestType": "SupportedProfiles"  
}
```

```
{  
  "requestType": "SupportedProfiles",  
  "motionProfiles": [  
    {  
      "key": "test",  
      "name": "test",  
      "defaultProfile": true,  
      "parameters": [  
        {  
          "key": "V",  
          "name": "V",  
          "required": true  
        },  
        {  
          "key": "A",  
          "name": "A",  
          "required": true  
        },  
        {  
          "key": "J",  
          "name": "J",  
          "required": true  
        }  
      ]  
    }  
  ]  
}
```

Validate

```

{
  "requestType": "Validate",
  "segments": [
    {
      "setPoints": [
        {
          "id": "X",
          "from": 0.3,
          "distance": 0,
          "settling": false,
          "motionProfileId": "ThirdOrderP2P",
          "arguments": {
            "A": 0.5,
            "S": 0.1,
            "V": 0.5,
            "J": 0.5
          }
        },
        {
          "id": "Y",
          "from": 0.15,
          "distance": -0.3,
          "settling": true,
          "motionProfileId": "ThirdOrderP2P",
          "arguments": {
            "A": 0.5,
            "S": 0.1,
            "V": 0.5,
            "J": 0.5
          }
        }
      ],
      "id": "nodeto A1"
    }
  ]
}

```

```

{
  "requestType": "Validate"
}

```

Calculate Times

```

{
  "requestType": "CalculateTimes",
  "segments": [
    {
      "setPoints": [
        {
          "id": "X",
          "from": 0.3,
          "distance": 0,
          "settling": false,
          "motionProfileId": "ThirdOrderP2P",
          "arguments": {
            "A": 0.5,
            "S": 0.1,
            "V": 0.5,
            "J": 0.5
          }
        },
        {
          "id": "Y",
          "from": 0.15,
          "distance": -0.3,
          "settling": true,
          "motionProfileId": "ThirdOrderP2P",
          "arguments": {
            "A": 0.5,
            "S": 0.1,
            "V": 0.5,
            "J": 0.5
          }
        }
      ],
      "id": "nodeto A1"
    }
  ]
}

```

```

{
  "requestType": "CalculateTimes",
  "times": [
    2.777731800328678
  ]
}

```

Position Info

```

{
  "requestType": "PositionInfo",
  "segments": [
    {
      "setPoints": [
        {
          "id": "X",
          "from": 0.3,
          "distance": 0,
          "settling": false,
          "motionProfileId": "ThirdOrderP2P",
          "arguments": {
            "A": 0.5,
            "S": 0.1,
            "V": 0.5,
            "J": 0.5
          }
        },
        {
          "id": "Y",
          "from": 0.15,
          "distance": -0.3,
          "settling": true,
          "motionProfileId": "ThirdOrderP2P",
          "arguments": {
            "A": 0.5,
            "S": 0.1,
            "V": 0.5,
            "J": 0.5
          }
        }
      ],
      "id": "nodeto A1"
    }
  ]
}

```

```

{
  "requestType": "PositionInfo",
  "positionInfo": [
    {
      "setPointId": "X",
      "timePositions": [
        [
          0.0,
          0.3
        ],
        [
          2.777731800328678,
          0.3
        ]
      ]
    },
    {
      "setPointId": "Y",
      "timePositions": [
        [
          0.0,
          0.15
        ],
        [
          0.4244,
          0.14362992010133332
        ]
      ]
    }
  ]
}

```

Error Response

```

{
  "requestType": "PositionInfo",
  "errorMessage": "anErrorMessage",
  "errorSegments": [
    "move passing",
    "move"
  ]
}

```

Background Eclipse LSAT™ Internal motion calculator API



This background is only for informational purposes.

Internally the motion calculator API in Eclipse LSAT™ consists of 2 interfaces:

Listing 6. MotionCalculator.java the regular API called by Eclipse LSAT™.

```
/**
 * Validates if this {@link MotionCalculator} is able to calculate the motion as
 * specified by <tt>segments</tt>.
 *
 * @param segments the specified motion.
 * @throws MotionException If this motion calculator is not able to calculate this
 * motion
 */
void validate(List<MotionSegment> segments) throws MotionValidationException;

/**
 * Calculate the motion times for the an array of concatenated segments.<br>
 * <b>IMPORTANT:</b> The time in the array is the end-time of the motion segment
 * measured from the start of the
 * concatenated move.
 *
 * @param segments
 * @return A list of {@link Double}s representing time in seconds where the index
 * of the array corresponds with the
 * index of the motion segment in the provided segment list.
 * @throws MotionException
 */
List<Double> calculateTimes(List<MotionSegment> segments) throws MotionException;

/**
 * Calculates the position information for all set-points in an array of
 * concatenated segments.
 *
 * @param segments
 * @return The PositionInfo per set point.
 * @throws MotionException
 */
Collection<PositionInfo> getPositionInfo(List<MotionSegment> segments) throws
MotionException;
}
```

Listing 7. *MotionProfileProvider.java* can be used to specify customised profiles that can be used in settings.

```
/**
 * Provides the supported profiles and its parameters.
 *
 * <p>
 * MotionCalculator providers that also implement this API can expect that only
supported profiles will be used
 * </p>
 * Example of a profile: <pre>
 *   {@link MotionProfile}
 *       key="ThirdOrderP2P"
 *       name="Third order point-to-point"
 *       url="optional url to online specification"
 *   {@link MotionProfileParameter} key="V" name="V" required="true"
 *   {@link MotionProfileParameter} key="A" name="A" required="true"
 *   {@link MotionProfileParameter} key="J" name="J" required="true"
 *   {@link MotionProfileParameter} key="S" name="S" required="false"
 * </pre>
 *
 * @return The supported profiles for an implementation
 * @throws MotionException
 */
Set<MotionProfile> getSupportedProfiles() throws MotionException;
}
```